

PROJECT MANUAL

CLAYTON B. WIRE DEFERRED MAINTENANCE PROJECT

Book 1 of 2

CONTRACT NUMBER: 0262-461-CBW-D-M

**SACRAMENTO CITY UNIFIED SCHOOL
DISTRICT**

TABLE OF CONTENTS FOR BOTH BOOK 1 AND 2**Procurement and Contracting Requirements**

<u>Division 0</u>	<u>Section</u>	<u>Title</u>
	00 01 01	Project Title Page
	00 01 10	Table of Contents

Solicitation

<u>Division 0</u>	<u>Section</u>	<u>Title</u>
	00 11 16	Notice to Bidders

Instructions for Procurement

<u>Division 0</u>	<u>Section</u>	<u>Title</u>
	00 21 13	Instructions to Bidders

Available Information

<u>Division 0</u>	<u>Section</u>	<u>Title</u>
	00 31 19	Existing Conditions

Procurement Forms and Supplements

<u>Division 0</u>	<u>Section</u>	<u>Title</u>
	00 41 13	Bid Form and Proposal
	00 43 13	Bid Bond
	00 43 36	Designated Subcontractors List
	00 45 01	Site Visit Certification
	00 45 19	Non-Collusion Declaration
	00 45 19.01	Iran Contracting Act Certification
	00 45 26	Workers' Compensation Certification
	00 45 46.01	Prevailing Wage and Related Labor Requirements Certification
	00 45 46.02	Disabled Veteran Business Enterprise Participation Certification
	00 45 46.03	Drug-Free Workplace Certification
	00 45 46.04	Tobacco-Free Environment Certification
	00 45 46.05	Hazardous Materials Certification
	00 45 46.06	Lead-Based Materials Certification
	00 45 46.08	Criminal Background Investigation/Fingerprinting Certification
	00 45 46.10	Roofing Project Certification
	00 45 49	Registered Subcontractors List
	00 45 90	Post Bid Interview

Contracting Forms and Supplements

<u>Division 0</u>	<u>Section</u>	<u>Title</u>
	00 52 13	Agreement Form – Stipulated Sum (Single-Prime Contract)
	00 56 00	Escrow Bid Documentation
	00 57 00	Escrow Agreement in Lieu of Retention

Project Forms

<u>Division 0</u>	<u>Section</u>	<u>Title</u>
	00 61 13.13	Performance Bond

00 61 13.16	Payment Bond
00 63 40	Allowance Expenditure Directive Form
00 63 47	Daily Force Account Report
00 63 57	Proposed Change Order Form
00 63 63	Change Order Form
00 65 19.26	Agreement and Release of Any and All Claims
00 65 36	Guarantee Form

Conditions of the Contract

<u>Division 0</u>	<u>Section</u>	<u>Title</u>
	00 72 13	General Conditions – Stipulated Sum (Single-Prime Contract)
	00 73 13	Special Conditions
	00 73 56	Hazardous Materials Procedures and Requirements
	Exhibit A	Site Logistics Plan
	Exhibit B	Report of Limited Hazardous Materials Surveys (Book 2 of 2)
	Exhibit C	Asphalt Scope
	Exhibit D	Roof Scope
	Exhibit E	Exterior Scope
	Exhibit F	Assessment Sheets
	Exhibit G	Technology Demolition Scope
	Exhibit H	Project Labor Agreement

General Requirements

<u>Division 1</u>	<u>Section</u>	<u>Title</u>
	01 11 00	Summary of Work

Price and Payment Procedures

<u>Division 1</u>	<u>Section</u>	<u>Title</u>
	01 21 00	Allowance
	01 25 13	Product Options and Substitutions
	01 26 00	Changes in the Work
	01 29 00	Application for Payment and Conditional and Unconditional Waiver and Release Forms

Administrative Requirements

<u>Division 1</u>	<u>Section</u>	<u>Title</u>
	01 31 19	Project Meetings
	01 32 13	Scheduling of Work
	01 33 00	Submittals
	01 35 13.23	Site Standards

Quality Requirements

<u>Division 1</u>	<u>Section</u>	<u>Title</u>
	01 41 00	Regulatory Requirements
	01 42 13	Abbreviations and Acronyms
	01 42 16	Definitions
	01 42 19	References
	01 43 00	Materials and Equipment
	01 45 00	Quality Control

Temporary Facilities and Controls

<u>Division 1</u>	<u>Section</u>	<u>Title</u>
	01 50 00	Temporary Facilities and Controls
	01 50 13	Construction Waste Management and Disposal

Product Requirements

<u>Division 1</u>	<u>Section</u>	<u>Title</u>
	01 64 00	Owner-Furnished Products
	01 66 00	Product Delivery, Storage and Handling

Execution and Closeout Requirements

<u>Division 1</u>	<u>Section</u>	<u>Title</u>
	01 73 29	Cutting and Patching
	01 76 00	Alteration Project Procedures
	01 77 00	Contract Closeout and Final Cleaning
	01 78 23	Operation and Maintenance Data
	01 78 36	Warranties
	01 78 39	Record Documents

Technical Specifications – See Book 2 of 2

Division 07	07 54 19	Polyvinyl Chloride Roofing
Division 07	07 31 13	Shingle Roof
Division 08	08 11 00	Metal Doors and Frames
Division 08	08 71 00	Door Hardware
Division 09	09 51 00	Acoustical Ceilings
Division 09	09 65 16	Resilient Flooring – Sheet Vinyl
Division 09	09 68 00	Carpet
Division 09	09 91 00	Painting
Division 10	10 21 13	Toilet Compartments and Cubicles
Division 26	26 50 00	Lighting
Division 32	32 12 00	Asphalt Paving

NOTICE TO BIDDERS

1. Notice is hereby given that the governing board ("Board") of the Sacramento City Unified School District ("District") will receive sealed bids for the following project, Bid No. 0262-461-CBW-D-M, Bid Package **Clayton B. Wire Deferred Maintenance Project**:
2. The Project consists of:

Deferred Maintenance Repairs to an Elementary School Campus

Construction Cost Estimate: \$1,900,000.00
3. To bid on this Project, the Bidder is required to possess one or more of the following State of California contractors' license(s):

A or B

The Bidder's license(s) must remain active and in good standing throughout the term of the Contract.
4. To bid on this Project, the Bidder is required to be registered as a public works contractor with the Department of Industrial Relations pursuant to the Labor Code.
5. Contract Documents will be available on or after Wednesday January 4, 2023, for review on e-Builder and can be downloaded at, <https://gateway.app.e-builder.net/app/bidders/landing?bidpackageid=cab1d7e1-014b-4d77-94be-f6c44ac48969>. In addition, Contract Documents are available for bidders' review at the following builders' exchanges:
 - a. A. Bay Area Builders Exchange, Builders Exchange of Stockton, CalBX, CMD, ConstructConnect, Construction Bidboard, Dodge, Marin Builder AssociaMcGraw-Hill Construction Plancenter, Nevada County Contractors' Association, Placer County Contractors' Association, Sacramento Regional BX, and Valley Contractors Exchange
6. Sealed bids will be received until **10:00 a.m., January 26, 2023**, at the District Facilities Office, 5735 47th Avenue, Sacramento, California 95824 at which time the bids will be opened and publicly read aloud. Any bid that is submitted after this time shall be nonresponsive and returned to the bidder. Any claim by a bidder of error in its bid must be made in compliance with section 5100 et seq. of the Public Contract Code.
7. Pursuant to Public Contract Code section 20111.5, only prequalified bidders will be eligible to submit a bid for this Project. Any bid submitted by a bidder who is not prequalified shall be non-responsive and returned unopened to the bidder.

8. All bids shall be on the form provided by the District. Each bid must conform and be responsive to all pertinent Contract Documents, including, but not limited to, the Instructions to Bidders.
9. A bid bond by an admitted surety insurer on the form provided by the District a cashier's check or a certified check, drawn to the order of the Sacramento City Unified School District, in the amount of ten percent (10%) of the total bid price, shall accompany the Bid Form and Proposal, as a guarantee that the Bidder will, within seven (7) calendar days after the date of the Notice of Award, enter into a contract with the District for the performance of the services as stipulated in the bid.
10. A **mandatory pre-bid** conference and site visit will be held on **Thursday, January 12, 2023, at 10:00 a.m. at Clayton B. Wire Elementary School 5100 El Paraiso Avenue, Sacramento, CA 95824.** All participants are required to sign in at Staff Parking Lot on East side of the Administration Building. The site visit is expected to take approximately 60 minutes. Failure to attend or tardiness will render bid ineligible.
11. The successful Bidder shall be required to furnish a 100% Performance Bond and a 100% Payment Bond if it is awarded the Contract for the Work.
12. The successful Bidder may substitute securities for any monies withheld by the District to ensure performance under the Contract, in accordance with the provisions of section 22300 of the Public Contract Code.
13. The successful bidder will be required to certify that it either meets the Disabled Veteran Business Enterprise ("DVBE") goal of three percent (3%) participation or made a good faith effort to solicit DVBE participation in this Contract if it is awarded the Contract for the Work.
14. The Contractor and all Subcontractors under the Contractor shall pay all workers on all Work performed pursuant to this Contract not less than the general prevailing rate of per diem wages and the general prevailing rate for holiday and overtime work as determined by the Director of the Department of Industrial Relations, State of California, for the type of work performed and the locality in which the work is to be performed within the boundaries of the District, pursuant to section 1770 et seq. of the California Labor Code. Prevailing wage rates are also available from the District or on the Internet at: <<http://www.dir.ca.gov>>.
15. This Project is subject to labor compliance monitoring and enforcement by the Department of Industrial Relations pursuant to Labor Code section 1771.4 and subject to the requirements of Title 8 of the California Code of Regulations. The successful Bidder shall comply with all requirements of Division 2, Part 7, Chapter 1, Articles 1-5 of the Labor Code.
16. The Contractor and all Subcontractors under the Contractor shall comply with applicable federal, State, and local requirements relating to COVID-19 or other public health emergency/epidemic/pandemic including, if required, preparing, posting, and implementing a Social Distancing Protocol. Contractor shall further comply with the SCUSD Board Resolution 3211 from 10/12/21 requiring workers on District sites to be fully vaccinated against COVID-19, or else subject to weekly testing for COVID-19.

17. The District shall award the Contract, if it awards it at all, to the lowest responsive responsible bidder based on:
 - A. The base bid amount only.
18. The Board reserves the right to reject any and all bids and/or waive any irregularity in any bid received. If the District awards the Contract, the security of unsuccessful bidder(s) shall be returned within sixty (60) days from the time the award is made. Unless otherwise required by law, no bidder may withdraw its bid for ninety (90) days after the date of the bid opening.
19. The District has entered into a Project Labor Agreement that is applicable to this Project. A copy of the Project Labor Agreement is available for review at the District Facilities Office and may be downloaded from the District's website, www.scusd.edu, using the <https://www.scusd.edu/pod/project-labor-agreement> link. The successful bidder and all subcontractors will be required to agree to be bound by the Project Labor Agreement.
20. The Contractor and all Subcontractors under the Contractor shall comply with applicable federal, State, and local requirements relating to COVID-19 or other public health emergency/epidemic/pandemic including, if required, preparing, posting, and implementing a Social Distancing Protocol. Contractor shall further comply with the SCUSD Board Resolution 3211 from 10/12/21 requiring workers on District sites to be fully vaccinated against COVID-19, or else subject to weekly testing for COVID-19.
21. The District shall award the Contract, if it awards it at all, to the lowest responsive responsible bidder based on:
 - A. The base bid amount only.
22. The Board reserves the right to reject any and all bids and/or waive any irregularity in any bid received. If the District awards the Contract, the security of unsuccessful bidder(s) shall be returned within sixty (60) days from the time the award is made. Unless otherwise required by law, no bidder may withdraw its bid for ninety (90) days after the date of the bid opening.

END OF DOCUMENT

INSTRUCTIONS TO BIDDERS

Bidders shall follow the instructions in this document, and shall submit all documents, forms, and information required for consideration of a bid.

Sacramento City Unified School District ("District") will evaluate information submitted by the apparent low Bidder and, if incomplete or unsatisfactory to District, Bidder's bid may be rejected at the sole discretion of District.

1. Bids are requested for a general construction contract, or work described in general, for the following project ("Project" or "Contract"):

Clayton B. Wire Deferred Maintenance Project

2. A Bidder and its subcontractors must possess the appropriate State of California contractors' license and must maintain the license throughout the duration of the project. Bidders must also be registered as a public works contractor with the Department of Industrial Relations pursuant to the Labor Code. Bids submitted by a contractor who is not properly licensed or registered shall be deemed nonresponsive and will not be considered.
3. The District has prequalified bidders pursuant to Public Contract Code section 20111.5. Only prequalified bidders will be eligible to submit a bid for this Project. Any bid submitted by a bidder who is not prequalified shall be deemed nonresponsive and will not be considered.
4. District will receive sealed bids from bidders as stipulated in the Notice to Bidders.
 - a. All bids must be sealed in an envelope, marked with the name and address of the Bidder, name of the Project, the Project Number and/or bid number, and time of bid opening.
 - b. Bids must be submitted to the District Office, Attn: Tina Alvarez-Bevens, 5735 47th Avenue, Sacramento, CA 95824 by date and time shown in the Notice to Bidders.
 - c. Bids must contain all documents as required herein.
5. Bidders are advised that on the date that bids are opened, telephones will not be available at the District Offices for use by bidders or their representatives. Bids will be opened at or after the time indicated for receipt of bids. The District reserves the right to verify the genuineness of any bid security.
6. Bidders must submit bids on the documents titled Bid Form and Proposal, and must submit all other required District forms. Bids not submitted on the District's required forms shall be deemed nonresponsive and shall not be considered. Additional sheets required to fully respond to requested information are permissible.

7. Bidders shall not modify the Bid Form and Proposal or qualify their bids. Bidders shall not submit to the District a re-formatted, re-typed, altered, modified, or otherwise recreated version of the Bid Form and Proposal or other District-provided document.
8. Bids shall be clearly written and without erasure or deletions. District reserves the right to reject any bid containing erasures, deletions, or illegible contents.
9. Bidders must supply all information required by each Bid Document. Bids must be full and complete. District reserves the right in its sole discretion to reject any bid as nonresponsive as a result of any error or omission in the bid. Bidders must complete and submit all of the following documents with the Bid Form and Proposal:
 - a. Bid Bond on the District's form, or other security.
 - b. Designated Subcontractors List.
 - c. Site Visit Certification, if a site visit was required.
 - d. Non-Collusion Declaration.
10. Bidders must submit with their bids cash, a cashier's check or a certified check payable to District, or a bid bond by an admitted surety insurer of not less than ten percent (10%) of amount of Base Bid, plus all additive alternates ("Bid Bond"). If Bidder chooses to provide a Bid Bond as security, Bidder must use the required form of corporate surety provided by District. The Surety on Bidder's Bid Bond must be an insurer admitted in the State of California and authorized to issue surety bonds in the State of California. Bids submitted without necessary bid security will be deemed nonresponsive and will not be considered.
11. If Bidder to whom the Contract is awarded fails or neglects to enter into the Contract and submit required bonds, insurance certificates, and all other required documents, within **SEVEN (7)** calendar days after the date of the Notice of Award, District may deposit Bid Bond, cashier's check, or certified check for collection, and proceeds thereof may be retained by District as liquidated damages for failure of Bidder to enter into Contract, in the sole discretion of District. It is agreed that calculation of damages District may suffer as a result of Bidder's failure to enter into the Contract would be extremely difficult and impractical to determine and that the amount of the Bidder's required bid security shall be the agreed and conclusively presumed amount of damages.
12. Bidders must submit with the bid the Designated Subcontractors List for those subcontractors who will perform any portion of Work, including labor, rendering of service, or specially fabricating and installing a portion of the Work or improvement according to detailed drawings contained in the plans and specifications, in excess of one half of one percent (0.5%) of total bid. Failure to submit this list when required by law shall result in bid being deemed nonresponsive and the bid will not be considered.
13. All of the listed subcontractors are required to be registered as a public works contractor with the Department of Industrial Relations pursuant to the Labor Code.

- a. An inadvertent error in listing the California contractor license number on the Designated Subcontractors List shall not be grounds for filing a bid protest or grounds for considering the bid nonresponsive if the correct contractor's license number is submitted to the District within 24 hours after the bid opening and the corrected number corresponds with the submitted name and location for that subcontractor.
 - b. An inadvertent error listing an unregistered subcontractor shall not be grounds for filing a bid protest or grounds for considering the bid nonresponsive provided that any of the following apply:
 - (1) The subcontractor is registered prior to the bid opening.
 - (2) The subcontractor is registered and has paid the penalty registration fee within 24 hours after the bid opening.
 - (3) The subcontractor is replaced by another registered subcontractor pursuant to Public Contract Code section 4107.
14. If a mandatory pre-bid conference and site visit ("Site Visit") is required as referenced in the Notice to Bidders, then Bidders must submit the Site Visit Certification with their Bid. District will transmit to all prospective Bidders of record such Addenda as District in its discretion considers necessary in response to questions arising at the Site Visit. Oral statements shall not be relied upon and will not be binding or legally effective. Addenda issued by the District as a result of the Site Visit, if any, shall constitute the sole and exclusive record and statement of the results of the Site Visit.
 15. Bidders shall submit the Non-Collusion Declaration with their bids. Bids submitted without the Non-Collusion Declaration shall be deemed nonresponsive and will not be considered.
 16. The Contractor and all Subcontractors under the Contractor shall pay all workers on all work performed pursuant to the Contract not less than the general prevailing rate of per diem wages and the general prevailing rate for holiday and overtime work as determined by the Director of the Department of Industrial Relations, State of California, for the type of work performed and the locality in which the work is to be performed within the boundaries of the District, pursuant to sections 1770 et seq. of the California Labor Code. Copies of the general prevailing rates of per diem wages for each craft, classification, or type of worker needed to execute the Contract, as determined by Director of the Department of Industrial Relations, are available upon request at the District's principal office. Prevailing wage rates are also available on the internet at <http://www.dir.ca.gov>.
 17. The District has entered into a Project Labor Agreement that is applicable to this Project. A copy of the Project Labor Agreement is available for review at the District Facilities Office and may be downloaded from the District's website, www.scusd.edu, using the <https://www.scusd.edu/pod/project-labor-agreement> link. The successful bidder and all subcontractors will be required to agree to be bound by the Project Labor Agreement.

18. Section 17076.11 of the Education Code requires school districts using funds allocated pursuant to the State of California School Facility Program for the construction and/or modernization of school building(s) to have a participation goal for disabled veteran business enterprises ("DVBE") of at least three percent (3%) per year of the overall dollar amount expended on projects that receive state funding or demonstrate its good faith effort to solicit DVBE participation in this Contract. In order to meet this requirement by demonstrating a good faith effort, Bidder must advertise for DVBE-certified subcontractors and suppliers before submitting its Bid. For any project that is at least partially state-funded, the lowest responsive responsible Bidder awarded the Contract must submit certification of compliance with the procedures for implementation of DVBE contracting goals within 24 hours of being notified of being the apparent low bidder, ~~its signed Agreement~~. DVBE Certification form is attached. Do not submit this form with your Bid.
19. Submission of bid signifies careful examination of Contract Documents and complete understanding of the nature, extent, and location of Work to be performed. Bidders must complete the tasks listed below as a condition to bidding, and submission of a bid shall constitute the Bidder's express representation to District that Bidder has fully completed the following:
 - a. Bidder has visited the Site, if required, and has examined thoroughly and understood the nature and extent of the Contract Documents, Work, Site, locality, actual conditions, as-built conditions, and all local conditions and federal, state and local laws, and regulations that in any manner may affect cost, progress, performance, or furnishing of Work or that relate to any aspect of the means, methods, techniques, sequences, or procedures of construction to be employed by Bidder and safety precautions and programs incident thereto;
 - b. Bidder has conducted or obtained and has understood all examinations, investigations, explorations, tests, reports, and studies that pertain to the subsurface conditions, as-built conditions, underground facilities, and all other physical conditions at or contiguous to the Site or otherwise that may affect the cost, progress, performance, or furnishing of Work, as Bidder considers necessary for the performance or furnishing of Work at the Contract Sum, within the Contract Time, and in accordance with the other terms and conditions of Contract Documents, including specifically the provisions of the General Conditions; and no additional examinations, investigations, explorations, tests, reports, studies, or similar information or data are or will be required by Bidder for such purposes;
 - c. Bidder has correlated its knowledge and the results of all such observations, examinations, investigations, explorations, tests, reports, and studies with the terms and conditions of the Contract Documents;
 - d. Bidder has given the District prompt written notice of all conflicts, errors, ambiguities, or discrepancies that it has discovered in or among the Contract Documents and the actual conditions, and the written resolution(s) thereof by the District is/are acceptable to Bidder;
 - e. Bidder has made a complete disclosure in writing to the District of all facts bearing upon any possible interest, direct or indirect, that Bidder believes any

representative of the District or other officer or employee of the District presently has or will have in this Contract or in the performance thereof or in any portion of the profits thereof;

- f. Bidder must, prior to bidding, perform the work, investigations, research, and analysis required by this document and that Bidder represented in its Bid Form and Proposal and the Agreement that it performed prior to bidding. Contractor under this Contract is charged with all information and knowledge that a reasonable bidder would ascertain from having performed this required work, investigation, research, and analysis. Bid prices must include entire cost of all work "incidental" to completion of the Work.
- g. Conditions Shown on the Contract Documents: Information as to underground conditions, as-built conditions, or other conditions or obstructions, indicated in the Contract Documents, e.g., on Drawings or in Specifications, has been obtained with reasonable care, and has been recorded in good faith. However, District only warrants, and Bidder may only rely, on the accuracy of limited types of information.
 - (1) As to above-ground conditions or as-built conditions shown or indicated in the Contract Documents, there is no warranty, express or implied, or any representation express or implied, that such information is correctly shown or indicated. This information is verifiable by independent investigation and Bidder is required to make such verification as a condition to bidding. In submitting its Bid, Bidder shall rely on the results of its own independent investigation. In submitting its Bid, Bidder shall not rely on District-supplied information regarding above-ground conditions or as-built conditions.
 - (2) As to any subsurface condition shown or indicated in the Contract Documents, Bidder may rely only upon the general accuracy of actual reported depths, actual reported character of materials, actual reported soil types, actual reported water conditions, or actual obstructions shown or indicated. District is not responsible for the completeness of such information for bidding or construction; nor is District responsible in any way for any conclusions or opinions that the Bidder has drawn from such information; nor is the District responsible for subsurface conditions that are not specifically shown (for example, District is not responsible for soil conditions in areas contiguous to areas where a subsurface condition is shown).
- h. Conditions Shown in Reports and Drawings Supplied for Informational Purposes: Reference is made to the document entitled Geotechnical Data, and the document entitled Existing Conditions, for identification of:
 - (1) Subsurface Conditions: Those reports of explorations and tests of subsurface conditions at or contiguous to the Site that have been utilized by Architect in preparing the Contract Documents; and
 - (2) Physical Conditions: Those drawings of physical conditions in or relating to existing surface or subsurface structures at or contiguous to

the Site that has been utilized by Architect in preparing the Contract Documents.

- (3) These reports and drawings are **not** Contract Documents and, except for any "technical" data regarding subsurface conditions specifically identified in Geotechnical Data and Existing Conditions, and underground facilities data, Bidder may not in any manner rely on the information in these reports and drawings. Subject to the foregoing, Bidder must make its own independent investigation of all conditions affecting the Work and must not rely on information provided by District.
20. Bids shall be based on products and systems specified in Contract Documents or listed by name in Addenda. Whenever in the Specifications any materials, process, or article is indicated or specified by grade, patent, or proprietary name, or by name of manufacturer, that Specification shall be deemed to be followed by the words "or equal." Bidder may, unless otherwise stated, offer any material, process, or article that shall be substantially equal or better in every respect to that so indicated or specified. The District is not responsible and/or liable in any way for a Contractor's damages and/or claims related, in any way, to that Contractor's basing its bid on any requested substitution that the District has not approved in advance and in writing. Contractors and materials suppliers who submit requests for substitutions prior to the award of the Contract must do so in writing and in compliance with Public Contract Code section 3400. All requests must comply with the following:
 - a. District must receive any notice of request for substitution of a specified item a minimum of **TEN (10)** calendar days prior to bid opening. The Successful Bidder will not be allowed to substitute specified items unless properly noticed.
 - b. Within 35 days after the date of the Notice of Award, the Successful Bidder shall submit data substantiating the request(s) for all substitution(s) containing sufficient information to assess acceptability of product or system and impact on Project, including, without limitation, the requirements specified in the Special Conditions and the Specifications. Insufficient information shall be grounds for rejection of substitution.
 - c. Approved substitutions, if any, shall be listed in Addenda. District reserves the right not to act upon submittals of substitutions until after bid opening.
 - d. Substitutions may be requested after Contract has been awarded only if indicated in and in accordance with requirements specified in the Special Conditions and the Specifications.
21. Bidders may examine any available "as-built" drawings of previous work by giving District reasonable advance notice. District will not be responsible for accuracy of "as-built" drawings. The document entitled Existing Conditions applies to all supplied "as-built" drawings.
22. All questions about the meaning or intent of the Contract Documents are to be directed via email to the District to include: **Chris Ralston at chris-ralston@scusd.edu, Tina Alvarez-Bevens at Tina-Alvarez-Bevens@scusd.edu,**

and Cassie Baugher at CBaugher@Kitchell.com. Interpretations or clarifications considered necessary by the District in response to such questions will be issued in writing by Addenda and emailed, faxed, mailed, or delivered to all parties recorded by the District as having received the Contract Documents or posted on the District's website at <https://gateway.app.e-builder.net/app/bidders/landing?bidpackageid=cab1d7e1-014b-4d77-94be-f6c44ac48969>. Questions received less than Six (6) calendar days prior to the date for opening bids may not be answered. Only questions answered by formal written Addenda will be binding. Oral and other interpretations or clarifications will be without legal effect.

23. Addenda may also be issued to modify other parts of the Contract Documents as deemed advisable by the District.
24. Each Bidder must acknowledge each Addendum in its Bid Form and Proposal by number or its Bid shall be considered non-responsive. Each Addendum shall be part of the Contract Documents. A complete listing of Addenda may be secured from the District.
25. This Contract may include alternates. Alternates are defined as alternate products, materials, equipment, systems, methods, or major elements of the construction that may, at the District's option and under terms established in the Contract and pursuant to section 20103.8 of the Public Contract Code, be selected for the Work.
26. The District shall award the Contract, if it awards it at all, to the lowest responsive responsible bidder based on the criteria as indicated in the Notice to Bidders. In the event two or more responsible bidders submit identical bids, the District shall select the Bidder to whom to award the Contract by lot.
27. Discrepancies between written words and figures, or words and numerals, will be resolved in favor of figures or numerals.
28. Bidders in contention for contract awards may be required to attend a Post-Bid interview, which will be set within three (3) calendar days following bid opening. A duly authorized representative of the apparent low bidder is required to attend the Post Bid Interview, in person. The apparent low bidder's authorized representative(s) must have (1) knowledge of how the bid submitted was prepared, (2) the person responsible for supervising performance of the Work, and (3) the authority to bind the apparent low bidder. Failure to attend the Post Bid Interview as scheduled will be considered just cause for the District to reject the Bid as nonresponsive.
29. Any bid protest by any Bidder regarding any other bid must be submitted in writing to the District, before 5:00 p.m. of the **THIRD (3rd)** business day following bid opening.
 - a. Only a Bidder who has actually submitted a bid, and who could be awarded the Contract if the bid protest is upheld, is eligible to submit a bid protest. Subcontractors are not eligible to submit bid protests. A Bidder may not rely on the bid protest submitted by another Bidder.

- b. A bid protest must contain a complete statement of any and all bases for the protest and all supporting documentation. Materials submitted after the bid protest deadline will not be considered.
 - c. The protest must refer to the specific portions of all documents that form the basis for the protest.
 - (1) Without limitation to any other basis for protest, an inadvertent error in listing the California contractor's license number on the Designated Subcontractors List shall not be grounds for filing a bid protest or grounds for considering the bid nonresponsive if the correct contractor's license number is submitted to the District within 24 hours after the bid opening and the corrected number corresponds with the submitted name and location for that subcontractor.
 - (2) Without limitation to any other basis for protest, an inadvertent error listing an unregistered subcontractor shall not be grounds for filing a bid protest or grounds for considering the bid nonresponsive provided that any of the following apply:
 - (i) The subcontractor is registered prior to the bid opening.
 - (ii) The subcontractor is registered and has paid the penalty registration fee within 24 hours after the bid opening.
 - (iii) The subcontractor is replaced by another registered subcontractor pursuant to Public Contract Code section 4107.
 - d. The protest must include the name, address and telephone number of the person representing the protesting party.
 - e. The party filing the protest must concurrently transmit a copy of the protest and any attached documentation to all other parties with a direct financial interest that may be adversely affected by the outcome of the protest. Such parties shall include all other bidders or proposers who appear to have a reasonable prospect of receiving an award depending upon the outcome of the protest.
 - f. The procedure and time limits set forth in this paragraph are mandatory and are each bidder's sole and exclusive remedy in the event of bid protest. Failure to comply with these procedures shall constitute a waiver of any right to further pursue the bid protest, including filing a Government Code Claim or legal proceedings.
30. The Bidder to whom Contract is awarded shall execute and submit the following documents by 5:00 p.m. of the **SEVENTH (7th)** calendar day following the date of the Notice of Intent to Award. Failure to properly and timely submit these documents entitles District to reject the bid as nonresponsive.
- a. Agreement: To be executed by successful Bidder. Submit two (2) copies, each bearing an original signature. An electronic signature shall be deemed to be the equivalent of the actual original signature

- b. Escrow of Bid Documentation: This must include all required documentation. See the document titled Escrow Bid Documentation for more information.
 - c. Performance Bond (100%): On the form provided in the Contract Documents and fully executed as indicated on the form.
 - d. Payment Bond (Contractor's Labor and Material Bond) (100%): On the form provided in the Contract Documents and fully executed as indicated on the form.
 - e. Insurance Certificates and Endorsements as required.
 - f. Workers' Compensation Certification.
 - g. Prevailing Wage and Related Labor Requirements Certification.
 - h. Disabled Veteran Business Enterprise Participation Certification.
 - i. Drug-Free Workplace Certification.
 - j. Tobacco-Free Environment Certification.
 - k. Hazardous Materials Certification.
 - l. Lead-Based Materials Certification.
 - m. Imported Materials Certification.
 - n. Criminal Background Investigation/Fingerprinting Certification.
 - o. Registered Subcontractors List: Must include Department of Industrial Relations (DIR) registration number of each subcontractor for all tiers.
31. Time for Completion: District may issue a Notice to Proceed within **NINETY (90)** days from the date of the Notice of Intent to Award. Once Contractor has received the Notice to Proceed, Contractor shall complete the Work within the period of time indicated in the Contract Documents.
- a. In the event that the District desires to postpone issuing the Notice to Proceed beyond this 90-day period, it is expressly understood that with reasonable notice to the Contractor, the District may postpone issuing the Notice to Proceed.
 - b. It is further expressly understood by Contractor that Contractor shall not be entitled to any claim of additional compensation as a result of the postponement of the issuance of the Notice to Proceed beyond a 90-day period. If the Contractor believes that a postponement of issuance of the Notice to Proceed will cause a hardship to the Contractor, the Contractor may terminate the Contract. Contractor's termination due to a postponement beyond this 90-day period shall be by written notice to District within **TEN (10)** calendar days after receipt by Contractor of District's notice of postponement.

- c. It is further understood by the Contractor that in the event that Contractor terminates the Contract as a result of postponement by the District, the District shall only be obligated to pay Contractor for the Work that Contractor had performed at the time of notification of postponement and which the District had in writing authorized Contractor to perform prior to issuing a Notice to Proceed.
 - d. Should the Contractor terminate the Contract as a result of a notice of postponement, District shall have the authority to award the Contract to the next lowest responsive responsible bidder.
32. District reserves the right to reject any or all bids, including without limitation the right to reject any or all nonconforming, nonresponsive, unbalanced, or conditional bids, to re-bid, and to reject the bid of any bidder if District believes that it would not be in the best interest of the District to make an award to that bidder, whether because the bid is not responsive or the bidder is unqualified or of doubtful financial ability or fails to meet any other pertinent standard or criteria established by District. District also reserves the right to waive any inconsequential deviations or irregularities in any bid. For purposes of this paragraph, an "unbalanced bid" is one having nominal prices for some work items and/or enhanced prices for other work items.
33. It is the policy of the District that no qualified person shall be excluded from participating in, be denied the benefits of, or otherwise be subjected to discrimination in any consideration leading to the award of contract, based on race, color, gender, sexual orientation, political affiliation, age, ancestry, religion, marital status, national origin, medical condition or disability. The Successful Bidder and its subcontractors shall comply with applicable federal and state laws, including, but not limited to the California Fair Employment and Housing Act, beginning with Government Code section 12900, and Labor Code section 1735.
34. Prior to the award of Contract, District reserves the right to consider the responsibility of the Bidder. District may conduct investigations as District deems necessary to assist in the evaluation of any bid and to establish the responsibility, including, without limitation, qualifications and financial ability of Bidders, proposed subcontractors, suppliers, and other persons and organizations to perform and furnish the Work in accordance with the Contract Documents to District's satisfaction within the prescribed time.
35. Bidder expressly acknowledges that it is familiar with and capable of complying with applicable federal, State, and local requirements relating to COVID-19 or other public health emergency/epidemic/pandemic including, if required, preparing, posting, and implementing a Social Distancing Protocol, and such costs shall be included in the bid.

END OF DOCUMENT

EXISTING CONDITIONS

1. Summary

This document describes existing conditions at or near the Project, and use of information available regarding existing conditions. This document is **not** part of the Contract Documents. See General Conditions for definition(s) of terms used herein.

2. Reports and Information on Existing Conditions

- a. Documents providing a general description of the Site and conditions of the Work may have been collected by the Sacramento City Unified School District ("District"), its consultants, contractors, and tenants. These documents may, but are not required to, include previous contracts, contract specifications, tenant improvement contracts, as-built drawings, utility drawings, and information regarding underground facilities.
- b. Information regarding existing conditions may be inspected at the District offices or the Construction Manager's offices, if any, and copies may be obtained at cost of reproduction and handling upon Bidder's agreement to pay for such copies. These reports, documents, and other information are **not** part of the Contract Documents. These reports, documents, and other information do **not** excuse Contractor from fulfilling Contractor's obligation to independently investigate any or all existing conditions or from using reasonable prudent measures to avoid damaging existing improvements.
- c. Information regarding existing conditions may also be included in the Project Manual, but shall **not** be considered part of the Contract Documents.
- d. Prior to commencing this Work, Contractor and the District's representative shall survey the Site to document the condition of the Site. Contractor will record the survey in digital videotape format and provide an electronic copy to the District within fourteen (14) days of the survey.
- e. Contractor may also document any pre-existing conditions in writing, provided that both the Contractor and the District's representative agree on said conditions and sign a memorandum documenting the same.
- f. The reports and other data or information regarding existing conditions and underground facilities at or contiguous to the Project are the following:
 - (1) Hazardous Material Report. (Exhibit B of this Document)

3. Use of Information

- a. Information regarding existing conditions was obtained only for use of District and its consultants, contractors, and tenants for planning and design and is **not** part of the Contract Documents.
- b. District does not warrant, and makes no representation regarding, the accuracy or thoroughness of any information regarding existing conditions. Bidder represents and agrees that in submitting a bid it is not relying on any information regarding existing conditions supplied by District.
- c. Under no circumstances shall District be deemed to warrant or represent existing above-ground conditions, as-built conditions, or other actual conditions, verifiable by independent investigation. These conditions are verifiable by Bidder by the performance of its own independent investigation that Bidder must perform as a condition to bidding and Bidder should not and shall not rely on this information or any other information supplied by District regarding existing conditions.
- d. Any information shown or indicated in the reports and other data supplied herein with respect to existing underground facilities at or contiguous to the Project may be based upon information and data furnished to District by the District's employees and/or consultants or builders of such underground facilities or others. District does not assume responsibility for the completeness of this information, and Bidder is solely responsible for any interpretation or conclusion drawn from this information.
- e. District shall be responsible only for the general accuracy of information regarding underground facilities, and only for those underground facilities that are owned by District, and only where Bidder has conducted the independent investigation required of it pursuant to the Instructions to Bidders, and discrepancies are not apparent.

4. Investigations/Site Examinations

- a. Before submitting a bid, each Bidder is responsible for conducting or obtaining any additional or supplementary examinations, investigations, explorations, tests, studies, and data concerning conditions (surface, subsurface, and underground facilities) at or contiguous to the Site or otherwise, that may affect cost, progress, performance, or furnishing of Work or that relate to any aspect of the means, methods, techniques, sequences, or procedures of construction to be employed by Bidder and safety precautions and programs incident thereto or that Bidder deems necessary to determine its Bid for performing and furnishing the Work in accordance with the time, price, and other terms and conditions of Contract Documents.
- b. On request, District will provide each Bidder access to the Site to conduct such examinations, investigations, explorations, tests, and studies, as each Bidder deems necessary for submission of a bid. Bidders must fill all holes and clean up and restore the Site to its former condition upon completion of its explorations, investigations, tests, and studies. Such investigations and Site examinations may be performed during any and all Site visits indicated in

the Notice to Bidders and only under the provisions of the Contract Documents, including, but not limited to, proof of insurance and obligation to indemnify against claims arising from such work, and District's prior approval.

END OF DOCUMENT

BID FORM AND PROPOSAL

To: Governing Board of the Sacramento City Unified School District ("District" or "Owner")

From: _____
(Proper Name of Bidder)

The undersigned declares that Bidder has read and understands the Contract Documents, including, without limitation, the Notice to Bidders and the Instructions to Bidders, and agrees and proposes to furnish all necessary labor, materials, and equipment to perform and furnish all work in accordance with the terms and conditions of the Contract Documents, including, without limitation, the Drawings and Specifications of Bid No. SCUSD 0262-461-CBW-R-M, for the following project known as:

Clayton B. Wire Deferred Maintenance Project

("Project" or "Contract") and will accept in full payment for that Work the following total lump sum amount, all taxes included:

_____ Dollars	\$ _____
BASE BID	

Allowance: Owner to equal 10% of Base Bid

_____ Dollars	\$ _____
Owner Allowance	

Allowance: Unforeseen Dry Rot, Structural Conditions

One Hundred Thousand and NO/100 Dollars	\$100,000.00
Unforeseen Dry Rot, Structural Conditions Allowance	

Allowance: Roofing Repairs

Fifteen Thousand and NO/100 Dollars	\$15,000.00
Roofing Repairs Allowance	

_____ dollars	\$ _____
TOTAL BID	

Additional Detail Regarding Calculation of Base Bid

1. **Allowances.** The Bidder's Total Bid shall include a 10% of Base Bid allowance for Owner, \$100,000 allowance for Unforeseen Dry Rot & Structural Conditions and \$15,000 allowance for Roofing Repairs Buildings P09, K-1, 002 (Portion not identified as being replaced), 004, 005, P05, & P10) relating to the Work. Contractor shall not bill for or be due any portion of these allowances unless the District has identified specific work, Contractor has submitted a price for that work or the District has proposed a price for that work, the District has accepted the cost for that work, and the District has prepared an Allowance Expenditure Directive incorporating that work. Contractor hereby authorizes the District to execute a unilateral deductive change order at or near the end of the Project for all or any portion of the allowance not allocated. Any unused portion of the allowance will revert back to the District documented by a deductive change order.
2. The undersigned has reviewed the Work outlined in the Contract Documents and fully understands the scope of Work required in this Proposal, understands the construction and project management function(s) is described in the Contract Documents, and that each Bidder who is awarded a contract shall be in fact a prime contractor, not a subcontractor, to the District, and agrees that its Proposal, if accepted by the District, will be the basis for the Bidder to enter into a contract with the District in accordance with the intent of the Contract Documents.
3. The undersigned has notified the District in writing of any discrepancies or omissions or of any doubt, questions, or ambiguities about the meaning of any of the Contract Documents, and has contacted the Construction Manager before bid date to verify the issuance of any clarifying Addenda.
4. The undersigned agrees to commence work under this Contract on the date established in the Contract Documents and to complete all work within the time specified in the Contract Documents.
5. The liquidated damages clause of the General Conditions and Agreement is hereby acknowledged.
6. It is understood that the District reserves the right to reject this bid and that the bid shall remain open to acceptance and is irrevocable for a period of ninety (90) days.
7. The following documents are attached hereto:
 - Bid Bond on the District's form or other security
 - Designated Subcontractors List
 - Site Visit Certification
 - Non-Collusion Declaration
 - Iran Contracting Act Certification

8. Receipt and acceptance of the following Addenda is hereby acknowledged:

No. _____, Dated _____	No. _____, Dated _____
No. _____, Dated _____	No. _____, Dated _____
No. _____, Dated _____	No. _____, Dated _____

9. Bidder acknowledges that the license required for performance of the Work is a **A or B** license.

10. Bidder hereby certifies that Bidder is able to furnish labor that can work in harmony with all other elements of labor employed or to be employed on the Work.

11. Bidder specifically acknowledges and understands that if it is awarded the Contract, that it shall perform the Work of the Project while complying with all requirements of the Department of Industrial Relations.

12. Bidder hereby certifies that its bid includes sufficient funds to permit Bidder to comply with all local, state or federal labor laws or regulations during the Project, including payment of prevailing wage, and that Bidder will comply with the provisions of Labor Code section 2810(d) if awarded the Contract

13. Bidder agrees to comply with all requirements of the Project Labor Agreement

14. Bidder represents that it is competent, knowledgeable, and has special skills with respect to the nature, extent, and inherent conditions of the Work to be performed. Bidder further acknowledges that there are certain peculiar and inherent conditions existent in the construction of the Work that may create, during the Work, unusual or peculiar unsafe conditions hazardous to persons and property.

15. Bidder expressly acknowledges that it is aware of such peculiar risks and that it has the skill and experience to foresee and to adopt protective measures to adequately and safely perform the Work with respect to such hazards.

16. Bidder expressly acknowledges that it is familiar with and capable of complying with applicable federal, State, and local requirements relating to COVID-19 or other public health emergency/epidemic/pandemic including, if required, preparing, posting, and implementing a Social Distancing Protocol.

17. Bidder expressly acknowledges that it is aware that if a false claim is knowingly submitted (as the terms "claim" and "knowingly" are defined in the California False Claims Act, Gov. Code, § 12650 et seq.), the District will be entitled to civil remedies set forth in the California False Claim Act. It may also be considered fraud and the Contractor may be subject to criminal prosecution.

18. The undersigned Bidder certifies that it is, at the time of bidding, and shall be throughout the period of the Contract, licensed by the State of California to do the

type of work required under the terms of the Contract Documents and registered as a public works contractor with the Department of Industrial Relations. Bidder further certifies that it is regularly engaged in the general class and type of work called for in the Contract Documents.

Furthermore, Bidder hereby certifies to the District that all representations, certifications, and statements made by Bidder, as set forth in this bid form, are true and correct and are made under penalty of perjury.

Dated this _____ day of _____ 20 ____

Name of Bidder: _____

Type of Organization: _____

Signature: _____

Print Name: _____

Title: _____

Address of Bidder: _____

Taxpayer Identification No. of Bidder: _____

Telephone Number: _____

Fax Number: _____

E-mail: _____ Web Page: _____

Contractor's License No(s): No.: _____ Class: _____ Expiration Date: _____

No.: _____ Class: _____ Expiration Date: _____

No.: _____ Class: _____ Expiration Date: _____

Public Works Contractor Registration No.: _____

END OF DOCUMENT

BID BOND

(Note: If Bidder is providing a bid bond as its bid security, Bidder must use this form, NOT a surety company form.)

KNOW ALL PERSONS BY THESE PRESENTS:

That the undersigned, _____, as Principal ("Principal"),

and _____, as Surety ("Surety"), a corporation organized and existing under and by virtue of the laws of the State of California and authorized to do business as a surety in the State of California, are held and firmly bound unto the Sacramento City Unified School District ("District") of Sacramento County, State of California, as Obligee, in an amount equal to ten percent (10%) of the Base Bid plus alternates, in the sum of

_____ Dollars (\$ _____)

lawful money of the United States of America, for the payment of which sum well and truly to be made, we, and each of us, bind ourselves, our heirs, executors, administrators, successors, and assigns, jointly and severally, firmly by these presents.

THE CONDITION OF THIS OBLIGATION IS SUCH that whereas the Principal has submitted a bid to the District for all Work specifically described in the accompanying bid for the following project: **Bid Package 0262-461-CBW-D-M and Clayton B. Wire Deferred Maintenance Project** ("Project" or "Contract").

NOW, THEREFORE, if the Principal is awarded the Contract and, within the time and manner required under the Contract Documents, after the prescribed forms are presented to Principal for signature, enters into a written contract, in the prescribed form in accordance with the bid, and files two bonds, one guaranteeing faithful performance and the other guaranteeing payment for labor and materials as required by law, and meets all other conditions to the Contract between the Principal and the Obligee becoming effective, or if the Principal shall fully reimburse and save harmless the Obligee from any damage sustained by the Obligee through failure of the Principal to enter into the written contract and to file the required performance and labor and material bonds, and to meet all other conditions to the Contract between the Principal and the Obligee becoming effective, then this obligation shall be null and void; otherwise, it shall be and remain in full force and effect. The full payment of the sum stated above shall be due immediately if Principal fails to execute the Contract within seven (7) days of the date of the District's Notice of Intent to Award to Principal.

Surety, for value received, hereby stipulates and agrees that no change, extension of time, alteration or addition to the terms of the Contract or the call for bids, or to the work to be performed thereunder, or the specifications accompanying the same, shall in any way affect its obligation under this bond, and it does hereby waive notice of any such change, extension of time, alteration or addition to the terms of the Contract or the call for bids, or to the work, or to the specifications.

In the event suit is brought upon this bond by the Obligee and judgment is recovered, the Surety shall pay all costs incurred by the Obligee in such suit, including a reasonable attorneys' fee to be fixed by the Court.

If the District awards the bid, the security of unsuccessful bidder(s) shall be returned within sixty (60) days from the time the award is made. Unless otherwise required by law, no bidder may withdraw its bid for ninety (90) days after the date of the bid opening.

IN WITNESS WHEREOF, this instrument has been duly executed by the Principal and Surety above named, on the _____ day of _____, 20__.

Principal

By

Surety

By

Name of California Agent of Surety

Address of California Agent of Surety

Telephone Number of California Agent of Surety

Bidder must attach Power of Attorney and Certificate of Authority for Surety and a Notarial Acknowledgment for all Surety's signatures. The California Department of Insurance must authorize the Surety to be an admitted Surety Insurer.

END OF DOCUMENT

DESIGNATED SUBCONTRACTORS LIST
(Public Contact Code Sections 4100-4114)

PROJECT: **0262-461-CBW-D-M Clayton B. Wire Deferred Maintenance**

Bidder acknowledges and agrees that it must clearly set forth below the name, location and California contractor license number of each subcontractor who will perform work or labor or render service to the Bidder in or about the construction of the Work or who will specially fabricate and install a portion of the Work according to detailed drawings contained in the plans and specifications in an amount in excess of one-half of one percent (0.5%) of Bidder's total Base Bid and the kind of Work that each will perform. Vendors or suppliers of materials only do not need to be listed.

Bidder acknowledges and agrees that, if Bidder fails to list as to any portion of Work, or if Bidder lists more than one subcontractor to perform the same portion of Work, Bidder must perform that portion itself or be subjected to penalty under applicable law. In case more than one subcontractor is named for the same kind of Work, state the portion of the kind of Work that each subcontractor will perform.

If alternate bid(s) is/are called for and Bidder intends to use subcontractors different from or in addition to those subcontractors listed for work under the Base Bid, Bidder must list subcontractors that will perform Work in an amount in excess of one half of one percent (0.5%) of Bidder's total Base Bid plus alternate(s).

If further space is required for the list of proposed subcontractors, attach additional copies of page 2 showing the required information, as indicated below.

Subcontractor Name: _____

CA Cont. Lic. #: _____ Location: _____

DIR Registration #: _____

Portion of Work: _____

Subcontractor Name: _____

CA Cont. Lic. #: _____ Location: _____

DIR Registration #: _____

Portion of Work: _____

Subcontractor Name: _____

CA Cont. Lic. #: _____ Location: _____

DIR Registration #: _____

Portion of Work: _____

Subcontractor Name: _____

CA Cont. Lic. #: _____ Location: _____

DIR Registration #: _____

Portion of Work: _____

Subcontractor Name: _____

CA Cont. Lic. #: _____ Location: _____

DIR Registration #: _____

Portion of Work: _____

Subcontractor Name: _____

CA Cont. Lic. #: _____ Location: _____

DIR Registration #: _____

Portion of Work: _____

Subcontractor Name: _____

CA Cont. Lic. #: _____ Location: _____

DIR Registration #: _____

Portion of Work: _____

Subcontractor Name: _____

CA Cont. Lic. #: _____ Location: _____

DIR Registration #: _____

Portion of Work: _____

Date: _____

Proper Name of Bidder: _____

Signature: _____

Print Name: _____

Title: _____

END OF DOCUMENT

SITE VISIT CERTIFICATION

TO BE EXECUTED BY BIDDER AND SUBMITTED WITH BID
IF SITE VISIT WAS MANDATORY

PROJECT: **0262-461-CBW-D-M Clayton B. Wire Deferred Maintenance Project**

Check option that applies:

_____ I certify that I visited the Site of the proposed Work, received the attached _____ pages of information, and became fully acquainted with the conditions relating to construction and labor. I fully understand the facilities, difficulties, and restrictions attending the execution of the Work under contract.

_____ I certify that _____ (Bidder's representative) visited the Site of the proposed Work, received the attached _____ pages of information, and became fully acquainted with the conditions relating to construction and labor. The Bidder's representative fully understood the facilities, difficulties, and restrictions attending the execution of the Work under contract.

Bidder fully indemnifies the Sacramento City Unified School District, its Architect, its Engineers, its Construction Manager, and all of their respective officers, agents, employees, and consultants from any damage, or omissions, related to conditions that could have been identified during my visit and/or the Bidder's representative's visit to the Site.

I certify under penalty of perjury under the laws of the State of California that the foregoing is true and correct.

Date: _____

Proper Name of Bidder: _____

Signature: _____

Print Name: _____

Title: _____

ATTACHMENTS:

- 1.
- 2.
- 3.

END OF DOCUMENT

**NON-COLLUSION DECLARATION
(Public Contract Code Section 7106)**

The undersigned declares:

I am the _____ of _____, the party making the foregoing bid.
[Title] [Name of Firm]

The bid is not made in the interest of, or on behalf of, any undisclosed person, partnership, company, association, organization, or corporation. The bid is genuine and not collusive or sham. The bidder has not directly or indirectly induced or solicited any other bidder to put in a false or sham bid. The bidder has not directly or indirectly colluded, conspired, connived, or agreed with any bidder or anyone else to put in a sham bid, or to refrain from bidding. The bidder has not in any manner, directly or indirectly, sought by agreement, communication, or conference with anyone to fix the bid price of the bidder or any other bidder, or to fix any overhead, profit, or cost element of the bid price, or of that of any other bidder. All statements contained in the bid are true. The bidder has not, directly or indirectly, submitted his or her bid price or any breakdown thereof, or the contents thereof, or divulged information or data relative thereto, to any corporation, partnership, company, association, organization, bid depository, or to any member or agent thereof, to effectuate a collusive or sham bid, and has not paid, and will not pay, any person or entity for such purpose.

Any person executing this declaration on behalf of a bidder that is a corporation, partnership, joint venture, limited liability company, limited liability partnership, or any other entity, hereby represents that he or she has full power to execute, and does execute, this declaration on behalf of the bidder.

I declare under penalty of perjury under the laws of the State of California that the foregoing is true and correct and that this declaration is executed on _____,
[Date]

at _____, _____.
[City] [State]

Date: _____

Proper Name of Bidder: _____

Signature: _____

Print Name: _____

Title: _____

END OF DOCUMENT

IRAN CONTRACTING ACT CERTIFICATION
(Public Contract Code Sections 2202-2208)

PROJECT/CONTRACT NO.: **0262-461-CBW-D-M Clayton B. Wire Deferred Maintenance Project** between the Sacramento City Unified School District ("District") and _____ ("Contractor" or "Bidder") ("Contract" or "Project").

Prior to bidding on or submitting a proposal for a contract for goods or services of \$1,000,000 or more, the bidder/proposer must submit this certification pursuant to Public Contract Code section 2204.

The bidder/proposer must complete **ONLY ONE** of the following two options. To complete OPTION 1, check the corresponding box **and** complete the certification below. To complete OPTION 2, check the corresponding box, complete the certification below, and attach documentation demonstrating the exemption approval.

- OPTION 1.** Bidder/Proposer is not on the current list of persons engaged in investment activities in Iran created by the California Department of General Services ("DGS") pursuant to Public Contract Code section 2203(b), and we are not a financial institution extending twenty million dollars (\$20,000,000) or more in credit to another person, for 45 days or more, if that other person will use the credit to provide goods or services in the energy sector in Iran and is identified on the current list of persons engaged in investment activities in Iran created by DGS.

- OPTION 2.** Bidder/Proposer has received a written exemption from the certification requirement pursuant to Public Contract Code sections 2203(c) and (d). *A copy of the written documentation demonstrating the exemption approval is included with our bid/proposal.*

CERTIFICATION:

I, the official named below, CERTIFY UNDER PENALTY OF PERJURY, that I am duly authorized to legally bind the bidder/proposer to the OPTION selected above. This certification is made under the laws of the State of California.

<i>Vendor Name/Financial Institution (Printed)</i>	<i>Federal ID Number (or n/a)</i>
<i>By (Authorized Signature)</i>	
<i>Printed Name and Title of Person Signing</i>	<i>Date Executed</i>

END OF DOCUMENT

WORKERS' COMPENSATION CERTIFICATION

PROJECT/CONTRACT NO.: **0262-461-CBW-D-M Clayton B. Wire Deferred Maintenance** between the Sacramento City Unified School District ("District") and _____

_____ ("Contractor" or "Bidder") ("Contract" or "Project").

Labor Code section 3700, in relevant part, provides:

Every employer except the State shall secure the payment of compensation in one or more of the following ways:

- a. By being insured against liability to pay compensation by one or more insurers duly authorized to write compensation insurance in this state; and/or
- b. By securing from the Director of Industrial Relations a certificate of consent to self-insure, which may be given upon furnishing proof satisfactory to the Director of Industrial Relations of ability to self-insure and to pay any compensation that may become due to his employees.

I am aware of the provisions of section 3700 of the Labor Code which require every employer to be insured against liability for workers' compensation or to undertake self-insurance in accordance with the provisions of that code, and I will comply with such provisions before commencing the performance of the Work of this Contract.

Date: _____

Proper Name of Contractor: _____

Signature: _____

Print Name: _____

Title: _____

(In accordance with Labor Code sections 1860 and 1861, the above certificate must be signed and filed with the awarding body prior to performing any Work under this Contract.)

END OF DOCUMENT

DOCUMENT 00 45 46.01

**PREVAILING WAGE AND
RELATED LABOR REQUIREMENTS CERTIFICATION**

PROJECT/CONTRACT NO.: **0262-461-CBW-D-M Clayton B. Wire Deferred Maintenance** between
the Sacramento City Unified School District ("District") and _____

_____ ("Contractor" or "Bidder") ("Contract" or
"Project").

I hereby certify that I will conform to the State of California Public Works Contract requirements regarding prevailing wages, benefits, on-site audits with 48-hours' notice, payroll records, and apprentice and trainee employment requirements, for all Work on the above Project including, without limitation, labor compliance monitoring and enforcement by the Department of Industrial Relations.

Date: _____

Proper Name of Contractor: _____

Signature: _____

Print Name: _____

Title: _____

END OF DOCUMENT

**DISABLED VETERAN BUSINESS
ENTERPRISE PARTICIPATION CERTIFICATION**

PROJECT/CONTRACT NO.: SCUSD Bid# 0262-461-CBW-D-M Clayton B. Wire Deferred Maintenance Project between the Sacramento City Unified School District ("District") and _____

_____ ("Contractor" or "Bidder") ("Contract" or "Project").

GENERAL INSTRUCTIONS

Section 17076.11 of the Education Code requires school districts using, or planning to use, funds allocated pursuant to the State of California School Facility Program ("Program") for the construction and/or modernization of school buildings to have a participation goal for disabled veteran business enterprises ("DVBE") of at least three percent (3%) per year of the overall dollar amount expended each year by the school district on projects that receive state funding. Therefore, the lowest responsive responsible Bidder awarded the Contract must submit this document to the District with its executed Agreement, identifying the steps contractor took to solicit DVBE participation in conjunction with this Contract. **Do not submit this form with your bids. This Form must be provided to the District no later than 24 hours after bid opening.**

PART I – Method of Compliance with DVBE Participation Goals. Check the appropriate box to indicate your method of committing the contract dollar amount.

YOUR BUSINESS ENTERPRISE IS:	AND YOU WILL	AND YOU WILL
1.01 <input type="checkbox"/> Disabled veteran owned and your forces will perform at least 3% of this Contract	Include a copy of your DVBE letter from Office of Small Business and Disabled Veterans Business Enterprise Services ("OSDS")*	Complete Part 1 of this form and the Certification
1.02 <input type="checkbox"/> Disabled veteran owned but is unable to perform 3% of this Contract with your forces	Use DVBE subcontractors /suppliers to bring the Contract participation to at least 3%	Include a copy of each DVBE's letter from OSDS (including yours, if applicable), and complete Part 1 of this form and the Certification
1.03 <input type="checkbox"/> NOT disabled veteran owned	Use DVBE subcontractors /suppliers for at least 3% of this Contract	
1.04 <input type="checkbox"/> Unable to meet the required participation goals after good faith efforts	Make good faith efforts, including contacts, advertisement and DVBE solicitation	Complete all of this form and the Certification

* A DVBE letter from OSDS is obtained from the participating DVBE.

You must complete the following table to show the dollar amount of DVBE participation:

	TOTAL CONTRACT PRICE
1.01 Prime Bidder, if DVBE (own participation)	\$
1.02 DVBE Subcontractor or Supplier	
A.	
B.	
C.	
D.	
1.03 Subtotal (A & B)	
1.04 Non-DVBE	
1.05 Total Bid	

PART II – Contacts. To identify DVBE subcontractors/suppliers for participation in your contract, you must contact each of the following categories. You should contact several DVBE organizations.

CATEGORY	TELEPHONE NUMBER	DATE CONTACTED	PERSON CONTACTED
A. The District, if any			*
B. OSDS, provides assistance locating DVBEs at https://caleprocure.ca.gov/pages/PublicSearch/supplier-search.aspx	(916) 375-4940		*
C. DVBE Organization (List)			*

*Write "recorded message" in this column, if applicable.

PART III – Advertisement. You must advertise for DVBE participation in both a trade and focus paper. List the advertisement you place to solicit DVBE participation. Advertisements should be published at least fourteen (14) days prior to bid/proposal opening; if you cannot advertise fourteen (14) days prior, advertisements should be published as soon as possible. Advertisements must include that your firm is seeking DVBE participation, the project name and location, and your firm’s name, your contact person, and telephone number. Attach copies of advertisements to this form.

FOCUS/TRADE PAPER NAME	CHECK ONE		DATE OF ADVERTISEMENT
	TRADE	FOCUS	

PART IV – DVBE Solicitations. List DVBE subcontractors/suppliers that were invited to bid. Use the following instructions to complete the remainder of this section (read the three columns as a sentence from left to right). If you need additional space to list DVBE solicitations, please use a separate page and attach to this form.

IF THE DVBE.....	THEN.....	AND.....		
was selected to participate	Check "YES" in the "SELECTED" column	include a copy of their DVBE letter(s) from OSDS		
was NOT selected to participate	Check "NO" in the "SELECTED" column	state why in the "REASON NOT SELECTED" column		
did not respond to your solicitation	Check the "NO RESPONSE" column.			
DVBE CONTACTED	SELECTED		REASON NOT SELECTED	NO RESPONSE
	YES	NO		

A copy of this form must be retained by you and may be subject to a future audit.

CERTIFICATION

I, _____, certify that I am the bidder's _____ and that I have made a diligent effort to ascertain the facts with regard to the representations made herein. In making this certification, I am aware of section 12650 et seq. of the Government Code providing for the imposition of treble damages for making false claims.

Date: _____

Proper Name of Contractor: _____

Signature: _____

Print Name: _____

Title: _____

END OF DOCUMENT

DRUG-FREE WORKPLACE CERTIFICATION

PROJECT/CONTRACT NO.: **SCUSD Bid#_0262-461-CBW-D-M Clayton B. Wire Deferred Maintenance Project** between the Sacramento City Unified School District ("District") and _____ ("Contractor" or "Bidder") ("Contract" or "Project").

This Drug-Free Workplace Certification form is required from the successful Bidder pursuant to Government Code section 8350 et seq., the Drug-Free Workplace Act of 1990. The Drug-Free Workplace Act of 1990 requires that every person or organization awarded a contract or grant for the procurement of any property or service from any state agency must certify that it will provide a drug-free workplace by doing certain specified acts. In addition, the Act provides that each contract or grant awarded by a state agency may be subject to suspension of payments or termination of the contract or grant, and the contractor or grantee may be subject to debarment from future contracting, if the contracting agency determines that specified acts have occurred.

The District is not a "state agency" as defined in the applicable section(s) of the Government Code, but the District is a local agency and public school district under California law and requires all contractors on District projects to comply with the provisions and requirements of the Drug-Free Workplace Act of 1990.

Contractor must also comply with the provisions of Health & Safety Code section 11362.3 which prohibits the consumption or possession of cannabis or cannabis products in any public place, including school grounds, and specifically on school grounds while children are present.

Contractor shall certify that it will provide a drug-free workplace by doing all of the following:

- a. Publishing a statement notifying employees that the unlawful manufacture, distribution, dispensation, possession, or use of a controlled substance is prohibited in the person's or organization's workplace and specifying actions which will be taken against employees for violations of the prohibition.
- b. Establishing a drug-free awareness program to inform employees about all of the following:
 - (1) The dangers of drug abuse in the workplace.
 - (2) The person's or organization's policy of maintaining a drug-free workplace.
 - (3) The availability of drug counseling, rehabilitation, and employee-assistance programs.
 - (4) The penalties that may be imposed upon employees for drug abuse violations.
- c. Requiring that each employee engaged in the performance of the contract or grant be given a copy of the statement required above, and that, as a

condition of employment on the contract or grant, the employee agrees to abide by the terms of the statement.

I, the undersigned, agree to fulfill the terms and requirements of Government Code section 8355 listed above and will publish a statement notifying employees concerning (a) the prohibition of controlled substance at the workplace, (b) establishing a drug-free awareness program, and (c) requiring that each employee engaged in the performance of the Contract be given a copy of the statement required by section 8355(a), and requiring that the employee agree to abide by the terms of that statement.

I also understand that if the District determines that I have either (a) made a false certification herein, or (b) violated this certification by failing to carry out the requirements of section 8355, that the Contract awarded herein is subject to termination, suspension of payments, or both. I further understand that, should I violate the terms of the Drug-Free Workplace Act of 1990, I may be subject to debarment in accordance with the requirements of the aforementioned Act.

I acknowledge that I am aware of the provisions of and hereby certify that I will adhere to the requirements of the Drug-Free Workplace Act of 1990 and Health and Safety Code section 11362.3.

Date: _____

Proper Name of Contractor: _____

Signature: _____

Print Name: _____

Title: _____

END OF DOCUMENT

TOBACCO-FREE ENVIRONMENT CERTIFICATION

PROJECT/CONTRACT NO.: **SCUSD Bid# 0262-461-CBW-D-M Clayton B. Wire Deferred Maintenance Project** between the Sacramento City Unified School District ("District") and _____ ("Contractor" or "Bidder") ("Contract" or "Project").

This Tobacco-Free Environment Certification form is required from the successful Bidder.

Pursuant to, without limitation, 20 U.S.C. section 6083, Labor Code section 6400 et seq., Health & Safety Code section 104350 et seq., Business and Professions Code section 22950 et seq., and District Board policies, all District sites, including the Project site, are tobacco-free environments. Smoking and the use of tobacco products by all persons is prohibited on or in District property. District property includes school buildings, school grounds, school-owned vehicles and vehicles owned by others while on District property. The prohibition on smoking includes the use of any electronic smoking device that creates an aerosol or vapor, in any manner or in any form, and the use of any oral smoking device for the purpose of circumventing the prohibition of tobacco smoking. Further, Health & Safety Code section 11362.3 prohibits the smoking or use of cannabis or cannabis products in any place where smoking tobacco is prohibited.

I acknowledge that I am aware of the District's policy regarding tobacco-free environments at District sites, including the Project site and hereby certify that I will adhere to the requirements of that policy and not permit any of my firm's employees, agents, subcontractors, or my firm's subcontractors' employees or agents, to use tobacco and/or smoke on the Project site.

Date: _____

Proper Name of Contractor: _____

Signature: _____

Print Name: _____

Title: _____

END OF DOCUMENT

HAZARDOUS MATERIALS CERTIFICATION

PROJECT/CONTRACT NO.: **SCUSD Bid# 0262-461-CBW-D-M Clayton B. Wire Deferred Maintenance Project** between Sacramento City Unified School District ("District") and _____ ("Contractor" or "Bidder") _____ ("Contract" or "Project").

1. Contractor hereby certifies that no asbestos, or asbestos-containing materials, polychlorinated biphenyl (PCB), or any material listed by the federal or state Environmental Protection Agency or federal or state health agencies as a hazardous material, or any other material defined as being hazardous under federal or state laws, rules, or regulations, ("New Hazardous Material"), shall be furnished, installed, or incorporated in any way into the Project or in any tools, devices, clothing, or equipment used to affect any portion of Contractor's work on the Project for District.
2. Contractor further certifies that it has instructed its employees with respect to the above-mentioned standards, hazards, risks, and liabilities.
3. Asbestos and/or asbestos-containing material shall be defined as all items containing but not limited to chrysotile, crocidolite, amosite, anthophyllite, tremolite, and actinolite. Any or all material containing greater than one-tenth of one percent (0.1%) asbestos shall be defined as asbestos-containing material.
4. Any disputes involving the question of whether or not material is New Hazardous Material shall be settled by electron microscopy or other appropriate and recognized testing procedure, at the District's determination. The costs of any such tests shall be paid by Contractor if the material is found to be New Hazardous Material.
5. All Work or materials found to be New Hazardous Material or Work or material installed with equipment containing New Hazardous Material will be immediately rejected and this Work will be removed at Contractor's expense at no additional cost to the District.
6. Contractor has read and understood the document titled Hazardous Materials Procedures & Requirements, and shall comply with all the provisions outlined therein. Contractor certifies that it is knowledgeable of, and shall comply with, all laws applicable to the Work including, but not limited to, all federal, state, and local laws, statutes, standards, rules, regulations, and ordinances applicable to the Work.

Date: _____

Proper Name of Contractor: _____

Signature: _____

Print Name: _____

Title: _____

END OF DOCUMENT

LEAD-BASED MATERIALS CERTIFICATION

PROJECT/CONTRACT NO.: **SCUSD Bid# 0262-461-CBW-D-M Clayton B. Wire Deferred Maintenance Project** between the Sacramento City Unified School District ("District") and _____ ("Contractor" or "Bidder")

("Contract" or "Project").

This certification provides notice to the Contractor that:

- (1) Contractor's work may disturb lead-containing building materials.
- (2) Contractor shall notify the District if any work may result in the disturbance of lead-containing building materials.
- (3) Contractor shall comply with the Renovation, Repair and Painting Rule, if lead-based paint is disturbed in a six-square-foot or greater area indoors or a 20-square-foot or greater area outdoors.

1. Lead as a Health Hazard

Lead poisoning is recognized as a serious environmental health hazard facing children today. Even at low levels of exposure, much lower than previously believed, lead can impair the development of a child's central nervous system, causing learning disabilities, and leading to serious behavioral problems. Lead enters the environment as tiny lead particles and lead dust disburse when paint chips, chalks, peels, wears away over time, or is otherwise disturbed. Ingestion of lead dust is the most common pathway of childhood poisoning; lead dust gets on a child's hands and toys and then into a child's mouth through common hand-to-mouth activity. Exposures may result from construction or remodeling activities that disturb lead paint, from ordinary wear and tear of windows and doors, or from friction on other surfaces.

Ordinary construction and renovation or repainting activities carried out without lead-safe work practices can disturb lead-based paint and create significant hazards. Improper removal practices, such as dry scraping, sanding, or water blasting painted surfaces, are likely to generate high volumes of lead dust.

Because the Contractor and its employees will be providing services for the District, and because the Contractor's work may disturb lead-containing building materials, CONTRACTOR IS HEREBY NOTIFIED of the potential presence of lead-containing materials located within certain buildings utilized by the District. All school buildings built prior to 1978 are presumed to contain some lead-based paint until sampling proves otherwise.

2. Overview of California Law

Education Code section 32240 et seq. is known as the Lead-Safe Schools Protection Act. Under this act, the Department of Health Services is to conduct a sample

survey of schools in the State of California for the purpose of developing risk factors to predict lead contamination in public schools. (Ed. Code, § 32241.)

Any school that undertakes any action to abate existing risk factors for lead is required to utilize trained and state-certified contractors, inspectors, and workers. (Ed. Code, § 32243, subd. (b).) Moreover, lead-based paint, lead plumbing, and solders, or other potential sources of lead contamination, shall not be utilized in the construction of any new school facility or the modernization or renovation of any existing school facility. (Ed. Code, § 32244.)

Both the Federal Occupational Safety and Health Administration ("Fed/OSHA") and the California Division of Occupational Safety and Health ("Cal/OSHA") have implemented safety orders applicable to all construction work where a contractor's employee may be occupationally exposed to lead.

The OSHA Regulations apply to all construction work where a contractor's employee may be occupationally exposed to lead. The OSHA Regulations contain specific and detailed requirements imposed on contractors subject to those regulations. The OSHA Regulations define construction work as work for construction, alteration, and/or repair, including painting and decorating. Regulated work includes, but is not limited to, the following:

- a. Demolition or salvage of structures where lead or materials containing lead are present;
- b. Removal or encapsulation of materials containing lead;
- c. New construction, alteration, repair, or renovation of structures, substrates, or portions thereof, that contain lead, or materials containing lead;
- d. Installation of products containing lead;
- e. Lead contamination/emergency cleanup;
- f. Transportation, disposal, storage, or containment of lead or materials containing lead on the site or location at which construction activities are performed; and
- g. Maintenance operations associated with the construction activities described in the subsection.

Because it is assumed by the District that all painted surfaces (interior as well as exterior) within the District contain some level of lead, it is imperative that the Contractor, its workers and subcontractors fully and adequately comply with all applicable laws, rules and regulations governing lead-based materials (including title 8, California Code of Regulations, section 1532.1).

Contractor shall notify the District if any Work may result in the disturbance of lead-containing building materials. Any and all Work that may result in the disturbance of lead-containing building materials shall be coordinated through the District. A signed copy of this Certification shall be on file prior

to beginning Work on the Project, along with all current insurance certificates.

3. Renovation, Repair and Painting Rule, Section 402(c)(3) of the Toxic Substances Control Act

The EPA requires lead safe work practices to reduce exposure to lead hazards created by renovation, repair and painting activities that disturb lead-based paint. Pursuant to the Renovation, Repair and Painting Rule (RRP), renovations in homes, childcare facilities, and schools built prior to 1978 must be conducted by certified renovations firms, using renovators with training by a EPA-accredited training provider, and fully and adequately complying with all applicable laws, rules and regulations governing lead-based materials, including those rules and regulations appearing within title 40 of the Code of Federal Regulations as part 745 (40 CFR 745).

The RRP requirements apply to all contractors who disturb lead-based paint in a six-square-foot or greater area indoors or a 20-square-foot or greater area outdoors. If a DPH-certified inspector or risk assessor determines that a home constructed before 1978 is lead-free, the federal certification is not required for anyone working on that particular building.

4. Contractor's Liability

If the Contractor fails to comply with any applicable laws, rules, or regulations, and that failure results in a site or worker contamination, the Contractor will be held solely responsible for all costs involved in any required corrective actions, and shall defend, indemnify, and hold harmless the District, pursuant to the indemnification provisions of the Contract, for all damages and other claims arising therefrom.

If lead disturbance is anticipated in the Work, only persons with appropriate accreditation, registrations, licenses, and training shall conduct this Work.

It shall be the responsibility of the Contractor to properly dispose of any and all waste products, including, but not limited to, paint chips, any collected residue, or any other visual material that may occur from the prepping of any painted surface. It will be the responsibility of the Contractor to provide the proper disposal of any hazardous waste by a certified hazardous waste hauler. This company shall be registered with the Department of Transportation (DOT) and shall be able to issue a current manifest number upon transporting any hazardous material from any school site within the District.

The Contractor shall provide the District with any sample results prior to beginning Work, during the Work, and after the completion of the Work. The District may request to examine, prior to the commencement of the Work, the lead training records of each employee of the Contractor.

THE CONTRACTOR HEREBY ACKNOWLEDGES, UNDER PENALTY OF PERJURY, THAT IT:

1. HAS RECEIVED NOTIFICATION OF POTENTIAL LEAD-BASED MATERIALS ON THE OWNER'S PROPERTY;

- 2.** IS KNOWLEDGEABLE REGARDING AND WILL COMPLY WITH ALL APPLICABLE LAWS, RULES, AND REGULATIONS GOVERNING WORK WITH, AND DISPOSAL, OF LEAD.

THE UNDERSIGNED WARRANTS THAT HE/SHE HAS THE AUTHORITY TO SIGN ON BEHALF OF AND BIND THE CONTRACTOR. THE DISTRICT MAY REQUIRE PROOF OF SUCH AUTHORITY.

Date: _____

Proper Name of Contractor: _____

Signature: _____

Print Name: _____

Title: _____

END OF DOCUMENT

CRIMINAL BACKGROUND INVESTIGATION
/FINGERPRINTING CERTIFICATION

PROJECT/CONTRACT NO.: **SCUSD Bid# 0262-461-CBW-D-M Clayton B. Wire Deferred Maintenance Project** between the Sacramento City Unified School District ("District") and _____ ("Contractor" or "Bidder")

("Contract" or "Project").

The undersigned does hereby certify to the District that I am a representative of the Contractor currently under contract with the District; that I am familiar with the facts herein certified; and that I am authorized and qualified to execute this certificate on behalf of Contractor.

Contractor certifies that it has taken at least one of the following actions (check all that apply):

- Pursuant to Education Code section 45125.2(a), Contractor has installed or will install, prior to commencement of Work, a physical barrier at the Work Site, that will limit contact between Contractor's employees, Subcontractors or suppliers and District pupils at all times; and/or
- Pursuant to Education Code section 45125.2(a), Contractor certifies that all employees will be under the continual supervision of, and monitored by, an employee of the Contractor who the California Department of Justice ("DOJ") has ascertained, or as described below, will ascertain, has not been convicted of a violent or serious felony. The name and title of the employee who will be supervising Contractor's and its subcontractors' or suppliers' employees is:

Name: _____

Title: _____

NOTE: If Contractor is a sole proprietor, and elects the above option, Contractor must have the above-named employee's fingerprints prepared and submitted by District for submission to the DOJ, in accordance with Education Code section 45125.1(h). No work shall commence until such determination by DOJ has been made.

- Pursuant to Education Code section 45125.2(a), the District will take appropriate steps to protect the safety of any pupils that may come in contact with Contractor's employees, subcontractors or suppliers so that the fingerprinting and criminal background investigation requirements of Education Code section 45125.2 shall not apply to Contractor under the Contract.
- The Work on the Contract is either (i) at an unoccupied school site and no employee of Contractor and/or subcontractor or supplier of any tier of the Contract shall come in contact with the District pupils or (ii) if Contractor's employees or any subcontractor or supplier of any tier of the Contract interacts with pupils, such interaction shall only take place under the immediate supervision and control of the pupil's parent or guardian or a school employee, so that the fingerprinting and criminal background investigation requirements of Education Code section 45125.1 shall not apply to Contractor under the Contract.

- The Contractor, who is not a sole proprietor, has complied with the fingerprinting requirements of Education Code section 45125.1 with respect to all Contractor's employees and all of its Subcontractors' employees who may have contact with District pupils in the course of providing services pursuant to the Contract, and the DOJ has determined (A) that none of those employees has been convicted of a felony, as that term is defined in Education Code section 45122.1 and/or (B) that the prohibition does not apply to an employee as provided by Education Code section 45125.1(e)(2) or (3). When the Contractor performs the criminal background check, it shall immediately provide any subsequent arrest and conviction information it receives to the District pursuant to the subsequent arrest service. No work shall commence until the Department of Justice ascertains that Contractor's employees and any subcontractors' employees have not been convicted of a felony as defined in Government Code Section 45122.1.

A complete and accurate list of Contractor's employees and of all of its subcontractors' employees who may come in contact with District pupils during the course and scope of the Contract is attached hereto as ATTACHMENT "A;" and/or

- The Contractor is a sole proprietor and intends to comply with the fingerprinting requirements of Education Code section 45125.1(h) with respect to all Contractor's employees who may have contact with District pupils in the course of providing services pursuant to the Contract, and hereby agrees to the District's preparation and submission of fingerprints such that the DOJ may determine (A) that none of those employees has been convicted of a felony, as that term is defined in Education Code section 45122.1 and/or (B) that the prohibition does not apply to an employee as provided by Education Code section 45125.1(e)(2) or (3). No work shall commence until the Department of Justice ascertains that Contractor's employees and any subcontractors' employees have not been convicted of a felony as defined in Government Code Section 45122.1.

Contractor's responsibility for background clearance extends to all of its employees, Subcontractors or suppliers, and employees of Subcontractors or suppliers coming into contact with District pupils regardless of whether they are designated as employees or acting as independent contractors of the Contractor.

[CONTINUED ON NEXT PAGE]

ATTACHMENT "A"

List of Employees/Subcontractors

Name/Company: _____

Name/Company: _____

Name/Company: _____

Name/Company: _____

Name/Company: _____

Name/Company: _____

Name/Company: _____

Name/Company: _____

Name/Company: _____

Name/Company: _____

Name/Company: _____

Name/Company: _____

Name/Company: _____

Name/Company: _____

Name/Company: _____

Name/Company: _____

Name/Company: _____

If further space is required for the list of employees/subcontractors, attach additional copies of this page.

Date: _____

Proper Name of Contractor: _____

Signature: _____

Print Name: _____

Title: _____

END OF DOCUMENT

REGISTERED SUBCONTRACTORS LIST
(Labor Code Section 1771.1)

PROJECT: SCUSD Bid# 0262-461-CBW-D-M Clayton B. Wire Deferred Maintenance Project

Date Submitted (for Updates): _____

Contractor acknowledges and agrees that it must clearly set forth below the name and Department of Industrial Relations (DIR) registration number of each subcontractor **for all tiers** who will perform work or labor or render service to Contractor or its subcontractors in or about the construction of the Work **at least two (2) weeks before the subcontractor is scheduled to perform work**. This document is to be updated as all tiers of subcontractors are identified.

Contractor acknowledges and agrees that, if Contractor fails to list as to any subcontractor of any tier who performs any portion of Work, the Contract is subject to cancellation and the Contractor will be subjected to penalty under applicable law.

If further space is required for the list of proposed subcontractors, attach additional copies of page 2 showing the required information, as indicated below.

Subcontractor Name: _____

DIR Registration #: _____

Portion of Work: _____

Subcontractor Name: _____

DIR Registration #: _____

Portion of Work: _____

Subcontractor Name: _____

DIR Registration #: _____

Portion of Work: _____

Subcontractor Name: _____

DIR Registration #: _____

Portion of Work: _____

Subcontractor Name: _____

DIR Registration #: _____

Portion of Work: _____

Subcontractor Name: _____

DIR Registration #: _____

Portion of Work: _____

Subcontractor Name: _____

DIR Registration #: _____

Portion of Work: _____

Subcontractor Name: _____

DIR Registration #: _____

Portion of Work: _____

Subcontractor Name: _____

DIR Registration #: _____

Portion of Work: _____

Subcontractor Name: _____

DIR Registration #: _____

Portion of Work: _____

Date: _____

Name of Contractor: _____

Signature: _____

Print Name: _____

Title: _____

END OF DOCUMENT

ROOFING PROJECT CERTIFICATION

PROJECT/CONTRACT NO. **0262-461-CBW-D-M Clayton B. Wire Deferred Maintenance Project** between the Sacramento City Unified School District ("District") and _____ ("Contractor" or "Bidder") ("Contract" or "Project").

Pursuant to Public Contract Code section 3000, et seq. this form shall be executed by all contractors, materials manufacturers, or vendors involved in a bid or proposal for the repair or replacement of a roof of a public school building where the project is either for repair of more than 25% of the roof or that has a total cost more than \$21,000 ("roofing project") and submitted to the District when the award is made.

Certification of: Contractor Materials Manufacturer
 Vendor Other _____

I, _____, _____, certify that I have not
 [Name] [Name of Firm]
offered, given, or agreed to give, received, accepted, or agreed to accept, any gift, contribution, or any financial incentive whatsoever to or from any person in connection with the roofing project contract. As used in this certification, "person" means any natural person, business, partnership, corporation, union, committee, club, or other organization, entity, or group of individuals.

Furthermore, I, _____, _____, certify that
 [Name] [Name of Firm]
I do not have, and throughout the duration of the contract, I will not have, any financial relationship in connection with the performance of this contract with any architect, engineer, roofing consultant, materials manufacturer, distributor, or vendor that is not disclosed below.

I, _____, _____, have the following
 [Name] [Name of Firm]
financial relationships with an architect, engineer, roofing consultant, materials manufacturer, distributor, or vendor, or other person in connection with the following roofing project contract (provide Name and Address of Building, and Contract Date and Number):

By my signature below, I hereby certify that, to the best of my knowledge, the contents of this disclosure are true, or are believed to be true. I further certify on behalf of the Firm that I am aware of section 3000 et seq. of the California Public Contract Code, and the sections referenced therein regarding the penalties for providing false information or failing to disclose a financial relationship in this disclosure. I further certify that I am authorized to make this certification on behalf of the Firm.

Date: _____

Proper Name of Firm: _____

Signature: _____

Print Name: _____

Title: _____

END OF DOCUMENT

POST BID INTERVIEW

PART 5 – GENERAL

5.01 SUMMARY

If requested by the District, this Section requires the apparent low bidder to attend and participate in a Post Bid Interview with the Construction Manager, prior to award of any contract by the District. The Post Bid Interview will be scheduled by the Construction Manager within three (3) calendar days after the date of bid.

5.02 REQUIRED ATTENDANCE

- A. A duly authorized representative of the apparent low bidder is required to attend the Post Bid Interview, in person.
- B. The apparent low bidder's authorized representative(s) must have (1) knowledge of how the bid submitted was prepared, (2) the person responsible for supervising performance of the Work, and (3) the authority to bind the apparent low bidder.
- C. Failure to attend the Post Bid Interview as scheduled will be considered just cause for the District to reject the Bid as nonresponsive.

5.03 POST BID INTERVIEW PROCEDURE

- A. The Construction Manager will review the Bid with the attendees.
- B. The Construction Manager will review the Contract Documents with the attendees, including but not limited to:
 - (1) Insurance
 - (2) Bonding
 - (3) Addenda
 - (4) Pre-Bid Clarifications
 - (5) Scope of Work
 - (6) Bid Packages Descriptions
 - (7) Bid Alternates
 - (8) Contract Plans
 - (9) Contract Specifications

- (10) Project Schedule and Schedule Requirements
- (11) Critical Dates Requirement for Other Bid Packages
- (12) Prevailing Wage Requirements
- (13) Liquidated Damages
- (14) Required Documentation for Contract Administration
- (15) Contract Coordination Requirements

5.04 POST BID INTERVIEW DOCUMENTATION

The Construction Manager will document the Post Bid Interview on the form attached to this Section. Both the apparent low bidder and the Construction Manager are required to sign the Post Bid Interview Documentation.

[REMAINDER OF PAGE INTENTIONALLY LEFT BLANK]

POST BID INTERVIEW

CONSTRUCTION MANAGER

[Name]
[Address 1]
[Address 2]
[Phone] [Fax]

BIDDER: _____

DATE: _____ TIME: _____ PHONE: _____

1. INTRODUCTIONS:
Present

a.	_____	_____
	CONTRACTOR	CONTRACTOR
	_____	_____
	[CM]	[CM]

2. PROPOSED CONTRACT:

3. PURPOSE OF INTERVIEW IS TO ASSURE A MUTUAL UNDERSTANDING OF THE FOLLOWING:

- | | | | |
|----|---|-----|----|
| a. | Do you acknowledge submission of a complete and accurate bid? | Yes | No |
| b. | Do you acknowledge the Bid Document submittal timelines after NOA and NTP and can you meet those timelines? | Yes | No |
| c. | Do you acknowledge the requirements for the escrow of bid documents? | Yes | No |
| d. | Are you comfortable with your listed subcontractors? | Yes | No |

CONTRACTUAL REQUIREMENTS:

- 4.
- | | | | |
|-----|--|-----|----|
| a. | Do you understand you are a prime contractor? | Yes | No |
| b. | Can you meet specified insurance requirements? | Yes | No |
| (1) | Do any of your policies that require Additional Insured endorsements exceed the minimum coverage requirements? | Yes | No |
| (2) | Are you requesting that the District accept an Excess Liability Insurance Policy to meet the policy limit? | Yes | No |

- (3) Will there be a gap between the per occurrence amount of any underlying policy and the start of the coverage under the Umbrella or Excess Liability Insurance Policy? Yes No
- c. Will you provide the Performance Bond and Labor and Material Bond for 100% of the Contract Price as stipulated? Yes No
- (1) Cost for bonds: _____% Yes No
- (2) Is the cost of your bonds in your base bid? Yes No
- (3) Is your surety licensed to issue bonds in California? Yes No
- d. Do you understand the fingerprinting requirements? Yes No
- e. Is it understood that all workers must be paid prevailing wage? Yes No
- f. Is it understood that all subcontractors of every tier must be registered as a public works contractor with the Department of Industrial Relations? Yes No
5. SCOPE OF WORK:
- a. Acknowledged Receipt of Addenda #1-___ Yes No
- b. Are the costs for addenda items included in your bid? (if applicable) Yes No
- c. Do you have a complete understanding of your Scope of Work under the proposed Agreement? Yes No
- d. You have re-reviewed the documents and understand the Scope of the Work. Are there any items that require clarification? Yes No
If yes, please identify them.
- (1) _____

- (2) _____

- (3) _____

- Is (are) there additional cost(s) for the above item(s)? Yes No
- e. Is the cost for allowance included in your bid? Yes No

- | | | | |
|----|--|-----|----|
| f. | Have you reviewed bid alternative(s) #1-___? (if applicable) | Yes | No |
| g. | Are the costs for bid alternatives included in your bid? | Yes | No |
| h. | Are the plans and specifications clear and understandable to your satisfaction? | Yes | No |
| i. | Do you acknowledge that the time to submit notice of requests for substitution of specified materials has expired? | Yes | No |
6. SCHEDULE:
- | | | | |
|----|--|-----|----|
| a. | Do you acknowledge and agree to the stipulated completion dates and milestones in the contract? | Yes | No |
| | (1) Will you provide a detailed construction schedule to _____ within the required ten (10) days of the Notice to Proceed, per the contract? | Yes | No |
| | (2) Can you meet the submittal deadline? | Yes | No |
| | (3) It is understood that the Project schedule is critical and that that weekend and overtime work may be required to meet the milestones. | Yes | No |
| | (4) It is understood that if rain does occur, then all dewatering and protection of work is required, per the contract. If not, what do you believe must change and why? _____ | Yes | No |
| | _____ | | |
| | _____ | | |
- | | | | |
|----|---|-----|----|
| b. | Identify critical materials, deliveries, long lead items and other dependencies, including Owner Furnished items that could affect the completion of your work. | Yes | No |
| | (1) _____ | | |
| | (2) _____ | | |
| | (3) _____ | | |
| | (4) _____ | | |
| | (5) _____ | | |
- | | | | |
|----|---|-----|----|
| c. | Do you understand that there is going to be maintenance and other construction taking place on site during the course of the project? | Yes | No |
|----|---|-----|----|

7. EXECUTION OF WORK

- a. Do you understand the access to the site? Yes No
- b. Do you understand the staging area restrictions? Yes No
- c. Have you included protection of [asphalt, floors, and roofs]? Yes No
- d. Do you understand that the site is occupied by students, teachers, administrators, parents, etc.? Yes No

8. CONTRACTOR COMMENTS/SUGGESTIONS:

- (1) _____
- (2) _____
- (3) _____
- (4) _____
- (5) _____

9. CONTRACTOR

You agree the information contained herein is part of your contractual obligations. Your signature acknowledges your agreement to perform all Work in the Contract Documents, and that costs for all Work are included in your bid.

The foregoing information is true and accurate, and I am authorized to sign as an officer of the company I am representing.

[Company Name]

Signature _____ Title: _____

Date: _____

10. CONSTRUCTION MANAGER

Signature _____ Title: _____

Date: _____

Title of Document: POST BID INTERVIEW

Number of Pages: _____

Date of Document: _____

END OF DOCUMENT

AGREEMENT

THIS AGREEMENT IS MADE AND ENTERED INTO THIS _____ DAY OF _____, 20____, by and between the Sacramento City Unified School District ("District") and _____ ("Contractor") ("Agreement").

WITNESSETH: That the parties hereto have mutually covenanted and agreed, and by these presents do covenant and agree with each other, as follows:

1. **The Work:** Contractor agrees to furnish all tools, equipment, apparatus, facilities, labor, and material necessary to perform and complete in a good and workmanlike manner, the work of the following project:

SCUSD Bid# 0262-461-CBW-D-M Clayton B. Wire Deferred Maintenance Project

It is understood and agreed that the Work shall be performed and completed as required in the Contract Documents including, without limitation, the Drawings and Specifications and submission of all documents required to secure funding or by the Division of the State Architect for close-out of the Project, under the direction and supervision of, and subject to the approval of, the District or its authorized representative.

2. **The Contract Documents:** The complete Contract consists of all Contract Documents as defined in the General Conditions and incorporated herein by this reference. Any and all obligations of the District and Contractor are fully set forth and described in the Contract Documents. All Contract Documents are intended to cooperate so that any Work called for in one and not mentioned in the other or vice versa is to be executed the same as if mentioned in all Contract Documents.
3. **Interpretation of Contract Documents:** Should any question arise concerning the intent or meaning of Contract Documents, including the Drawings or Specifications, the question shall be submitted to the District for interpretation. If a conflict exists in the Contract Documents, valid, written modifications, beginning with the most recent, shall control over this Agreement (if any), which shall control over the Special Conditions, which shall control over any Supplemental Conditions, which shall control over the General Conditions, which shall control over the remaining Division 0 documents, which shall control over Division 1 Documents which shall control over Division 2 through Division 49 documents, which shall control over figured dimensions, which shall control over large-scale drawings, which shall control over small-scale drawings. In the case of a discrepancy or ambiguity solely between and among the Drawings and Specifications, the discrepancy or ambiguity shall be resolved in favor of the interpretation that will provide District with the functionally complete and operable Project described in the Drawings and Specifications. In no case shall a document calling for lower quality and/or quantity material or workmanship control. The decision of the District in the matter shall be final.

4. **Time for Completion:** It is hereby understood and agreed that the Work under this Contract shall be completed within **Seventy (75)** consecutive calendar days ("Contract Time") from the date specified in the District's Notice to Proceed.
5. **Completion - Extension of Time:** Should the Contractor fail to complete this Contract, and the Work provided herein, within the time fixed for completion, due allowance being made for the contingencies provided for herein, the Contractor shall become liable to the District for all loss and damage that the District may suffer on account thereof. The Contractor shall coordinate its Work with the Work of all other contractors. The District shall not be liable for delays resulting from Contractor's failure to coordinate its Work with other contractors in a manner that will allow timely completion of Contractor's Work. Contractor shall be liable for delays to other contractors caused by Contractor's failure to coordinate its Work with the Work of other contractors.
6. **Liquidated Damages:** Time is of the essence for all work under this Agreement. It is hereby understood and agreed that it is and will be difficult and/or impossible to ascertain and determine the actual damage that the District will sustain in the event of and by reason of Contractor's delay; therefore, Contractor agrees that it shall pay to the District the sum of **Two Thousand Five Hundred and NO/100 dollars (\$2,500.00)** per day as liquidated damages for each and every day's delay beyond the time herein prescribed in completion of the Work.

It is hereby understood and agreed that this amount is not a penalty.

In the event that any portion of the liquidated damages is not paid to the District, the District may deduct that amount from any money due or that may become due the Contractor under this Agreement, and such deduction does not constitute a withholding or penalty. The District's right to assess liquidated damages is as indicated herein and in the General Conditions.

The time during which the Contract is delayed for cause, as hereinafter specified, may extend the time of completion for a reasonable time as the District may grant, provided that Contractor has complied with the claims procedure of the Contract Documents. This provision does not exclude the recovery of damages by either party under other provisions in the Contract Documents.

7. **Loss Or Damage:** The District and its agents and authorized representatives shall not in any way or manner be answerable or suffer loss, damage, expense, or liability for any loss or damage that may happen to the Work, or any part thereof, or in or about the same during its construction and before acceptance, and the Contractor shall assume all liabilities of every kind or nature arising from the Work, either by accident, negligence, theft, vandalism, or any cause whatsoever; and shall hold the District and its agents and authorized representatives harmless from all liability of every kind and nature arising from accident, negligence, or any cause whatsoever.
8. **Limitation Of District Liability:** District's financial obligations under this Contract shall be limited to the payment of the compensation provided in this Contract. Notwithstanding any other provision of this Contract, in no event shall District be liable, regardless of whether any claim is based on contract or tort, for any special, consequential, indirect or incidental damages, including, but not limited to, lost

profits or revenue, lost bonding capacity, arising out of or in connection with this Contract for the services performed in connection with this Contract.

9. **Insurance and Bonds:** Prior to issuance of the Notice to Proceed by the District, Contractor shall provide all required certificates of insurance, insurance endorsements, and payment and performance bonds as evidence thereof.
10. **Prosecution of Work:** If the Contractor should neglect to prosecute the Work properly or fail to perform any provisions of this Contract, the District, may, pursuant to the General Conditions and without prejudice to any other remedy it may have, make good such deficiencies and may deduct the cost thereof from the payment then or thereafter due the Contractor.
11. **Authority of Architect, Project Inspector, and DSA:** Contractor hereby acknowledges that the Architect(s), the Project Inspector(s), and the Division of the State Architect ("DSA") have authority to approve and/or suspend Work if the Contractor's Work does not comply with the requirements of the Contract Documents, Title 24 of the California Code of Regulations, and all applicable laws and regulations. The Contractor shall be liable for any delay caused by its non-compliant Work.
12. **Assignment of Contract:** Neither the Contract, nor any part thereof, nor any moneys due or to become due thereunder, may be assigned by the Contractor without the prior written approval of the District, nor without the written consent of the Surety on the Contractor's Performance Bond (the "Surety"), unless the Surety has waived in writing its right to notice of assignment.
13. **Classification of Contractor's License:** Contractor hereby acknowledges that it currently holds valid **A or B** Contractor's license(s) issued by the State of California, Contractors' State License Board, in accordance with division 3, chapter 9, of the Business and Professions Code and in the classification called for in the Contract Documents.
14. **Registration as Public Works Contractor:** The Contractor and all Subcontractors currently are registered as public works contractors with the Department of Industrial Relations, State of California, in accordance with Labor Code section 1771.1.
15. **Payment of Prevailing Wages:** The Contractor and all Subcontractors shall pay all workers on all Work performed pursuant to this Contract not less than the general prevailing rate of per diem wages and the general prevailing rate for holiday and overtime work as determined by the Director of the Department of Industrial Relations, State of California, for the type of work performed and the locality in which the work is to be performed within the boundaries of the District, pursuant to sections 1770 et seq. of the California Labor Code.
16. **Labor Compliance Monitoring and Enforcement:** This Project is subject to labor compliance monitoring and enforcement by the Department of Industrial Relations pursuant to Labor Code section 1771.4 and Title 8 of the California Code of Regulations. Contractor specifically acknowledges and understands that it shall perform the Work of this Agreement while complying with all the applicable provisions of Division 2, Part 7, Chapter 1, of the Labor Code, including, without

limitation, the requirement that the Contractor and all of its Subcontractors shall timely submit complete and accurate electronic certified payroll records as required by the Contract Documents, or the District may not issue payment.

17. **Contract Price:** In consideration of the foregoing covenants, promises, and agreements on the part of the Contractor, and the strict and literal fulfillment of each and every covenant, promise, and agreement, and as compensation agreed upon for the Work and construction, erection, and completion as aforesaid, the District covenants, promises, and agrees that it will well and truly pay and cause to be paid to the Contractor in full, and as the full Contract Price and compensation for construction, erection, and completion of the Work hereinabove agreed to be performed by the Contractor, the following price:

_____ Dollars
(\$ _____),

in lawful money of the United States, which sum is to be paid according to the schedule provided by the Contractor and accepted by the District and subject to additions and deductions as provided in the Contract. This amount supersedes any previously stated and/or agreed to amount(s).

18. **No Representations:** No representations have been made other than as set forth in writing in the Contract Documents, including this Agreement. Each of the Parties to this Agreement warrants that it has carefully read and understood the terms and conditions of this Agreement and all Contract Documents, and that it has not relied upon the representations or advice of any other Party or any attorney not its own.
19. **Entire Agreement:** The Contract Documents, including this Agreement, set forth the entire agreement between the parties hereto and fully supersede any and all prior agreements, understandings, written or oral, between the parties hereto pertaining to the subject matter thereof.
20. **Severability:** If any term, covenant, condition, or provision in any of the Contract Documents is held by a court of competent jurisdiction to be invalid, void or unenforceable, the remainder of the provisions in the Contract Documents shall remain in full force and effect and shall in no way be affected, impaired, or invalidated thereby.
21. **Authority of Signatories:** Each party has the full power and authority to enter into and perform this Contract, and the person signing this Contract on behalf of each party has been properly authorized and empowered to enter into this Contract. This Contract may be executed in one or more counterparts, each of which shall be deemed an original. For this Agreement, and for all Contract Documents requiring a signature, a facsimile or electronic signature shall be deemed to be the equivalent of the actual original signature. All counterparts so executed shall constitute one Contract binding all the Parties hereto.

[SIGNATURES ON FOLLOWING PAGE]

IN WITNESS WHEREOF, accepted and agreed on the date indicated above:

[CONTRACTOR NAME]

**SACRAMENTO CITY UNIFIED SCHOOL
DISTRICT**

By: _____

By: Rose F. Ramos

Title: _____

Title: Chief Business and Operation Office

NOTE: If the party executing this Contract is a corporation, a certified copy of the by-laws, or of the resolution of the Board of Directors, authorizing the officers of said corporation to execute the Contract and the bonds required thereby must be attached hereto.

END OF DOCUMENT

ESCROW BID DOCUMENTATION

1. Requirement to Escrow Bid Documentation

- a. Contractor shall submit, within **SEVEN (7)** calendar days after the date of the Notice of Intent to Award one copy of all documentary information received or generated by Contractor in preparation of bid prices for this Contract, as specified herein. This material is referred to herein as "Escrow Bid Documentation." The Escrow Bid Documentation of the Contractor will be held in escrow for the duration of the Contract.
- b. Contractor agrees, as a condition of award of the Contract, that the Escrow Bid Documentation constitutes all written information used in the preparation of its bid, and that no other written bid preparation information shall be considered in resolving disputes or claims. Contractor also agrees that nothing in the Escrow Bid Documentation shall change or modify the terms or conditions of the Contract Documents.
- c. The Escrow Bid Documentation will not be opened by District except as indicated herein. The Escrow Bid Documentation will be used only for the resolution of change orders and claims disputes.
- d. Contractor's submission of the Escrow Bid Documentation, as with the bonds and insurance documents required, is considered an essential part of the Contract award. Should the Contractor fail to make the submission within the allowed time specified above, District may deem the Contractor to have failed to enter into the Contract, and the Contractor shall forfeit the amount of its bid security, accompanying the Contractor's bid, and District may award the Contract to the next lowest responsive responsible bidder.
- e. NO PAYMENTS WILL BE MADE, NOR WILL DISTRICT ACCEPT PROPOSED CHANGE ORDERS UNTIL THE ABOVE REQUIRED INFORMATION IS SUBMITTED AND APPROVED.
- f. The Escrow Bid Documentation shall be submitted in person by an authorized representative of the Contractor to the District.

2. Ownership of Escrow Bid Documentation

- a. The Escrow Bid Documentation is, and shall always remain, the property of Contractor, subject to review by District, as provided herein.
- b. Escrow Bid Documentation constitute trade secrets, not known outside Contractor's business, known only to a limited extent and only by a limited number of employees of Contractor, safeguarded while in Contractor's possession, extremely valuable to Contractor, and could be extremely valuable to Contractor's competitors by virtue of reflecting Contractor's contemplated techniques of construction. Subject to the provisions herein, District agrees to safeguard the Escrow Bid Documentation, and all

information contained therein, against disclosure to the fullest extent permitted by law.

3. **Format and Contents of Escrow Bid Documentation**

- a. Contractor may submit Escrow Bid Documentation in its usual cost-estimating format; a standard format is not required. The Escrow Bid Documentation shall be submitted in the language (e.g., English) of the specification.
- b. Escrow Bid Documentation must clearly itemize the estimated costs of performing the work of each bid item contained in the bid schedule, separating bid items into sub-items as required to present a detailed cost estimate and allow a detailed cost review. The Escrow Bid Documentation shall include all subcontractor bids or quotes, supplier bids or quotes, quantity takeoffs, crews, equipment, calculations of rates of production and progress, copies of quotes from subcontractors and suppliers, and memoranda, narratives, add/deduct sheets, and all other information used by the Contractor to arrive at the prices contained in the bid proposal. Estimated costs should be broken down into Contractor's usual estimate categories such as direct labor, repair labor, equipment ownership and operation, expendable materials, permanent materials, and subcontract costs as appropriate. All labor rates must be broken down to specify any and all burden costs including, but not limited to, health and welfare pay, vacation and holiday pay, pension contributions, training rates, benefits of any kind, insurance of any kind, workers' compensation, liability insurance, truck expenses, supply expenses of any kind, payroll taxes, and any other taxes of any kind. Plant and equipment and indirect costs should be detailed in the Contractor's usual format. The Contractor's allocation of indirect costs, contingencies, markup, and other items to each bid item shall be identified.
- c. All costs shall be identified. For bid items amounting to less than \$10,000, estimated unit costs are acceptable without a detailed cost estimate, provided that labor, equipment, materials, and subcontracts, as applicable, are included and provided that indirect costs, contingencies, and markup, as applicable, are allocated.
- d. Bid Documentation provided by District should not be included in the Escrow Bid Documentation unless needed to comply with the following requirements.

4. **Submittal of Escrow Bid Documentation**

- a. The Escrow Bid Documentation shall be submitted by the Contractor in a sealed container within **SEVEN (7)** calendar days after the date of the Notice of Intent to Award. The container shall be clearly marked on the outside with the Contractor's name, date of submittal, project name and the words "Escrow Bid Documentation – Intended to be opened in the presence of Authorized Representatives of Both District and Contractor".
- b. By submitting Escrow Bid Documentation, Contractor represents that the material in the Escrow Bid Documentation constitutes all the documentary information used in preparation of the bid and that the Contractor has

personally examined the contents of the Escrow Bid Documentation container and has found that the documents in the container are complete.

- c. If Contractor's proposal is based upon subcontracting any part of the work, each subcontractor whose total subcontract price exceeds 5 percent of the total contract price proposed by Contractor, shall provide separate Escrow Documents to be included with those of Contractor. Those documents shall be opened and examined in the same manner and at the same time as the examination described above for Contractor.
- d. If Contractor wishes to subcontract any portion of the Work after award, District retains the right to require Contractor to submit Escrow Documents for the Subcontractor before the subcontract is approved.

5. **Storage, Examination and Final Disposition of Escrow Bid Documentation**

- a. The Escrow Bid Documentation will be placed in escrow, for the life of the Contract, in a mutually agreeable institution. The cost of storage will be paid by Contractor for the duration of the project until final Contract payment. The storage facilities shall be the appropriate size for all the Escrow Bid Documentation and located conveniently to both District's and Contractor's offices.
- b. The Escrow Bid Documentation shall be examined by both District and Contractor, at any time deemed necessary by either District or Contractor, to assist in the negotiation of price adjustments and change orders or the settlement of disputes and claims. In the case of legal proceedings, Escrow Bid Documentation shall be used subject to the terms of an appropriate protective order if requested by Contractor and ordered by a court of competent jurisdiction. Examination of the Escrow Bid Documentation is subject to the following conditions:
 - (1) As trade secrets, the Escrow Bid Documentation is proprietary and confidential to the extent allowed by law.
 - (2) District and Contractor shall each designate, in writing to the other party **SEVEN (7)** calendar days prior to any examination, the names of representatives who are authorized to examine the Escrow Bid Documentation. No other person shall have access to the Escrow Bid Documentation.
 - (3) Access to the documents may take place only in the presence of duly designated representatives of the District and Contractor. If Contractor fails to designate a representative or appear for joint examination on **SEVEN (7)** calendar days' notice, then the District representative may examine the Escrow Bid Documents alone upon an additional **THREE (3)** calendar days' notice if a representative of the Contractor does not appear at the time set.
 - (4) If a subcontractor has submitted sealed information to be included in the Escrow Bid Documents, access to those documents may take place only in the presence of a duly designated representative of the District,

Contractor and that subcontractor. If that subcontractor fails to designate a representative or appear for joint examination on **SEVEN (7)** calendar days' notice, then the District representative and/or the Contractor may examine the Escrow Bid Documentation without that subcontractor present upon an additional **THREE (3)** calendar days' notice if a representative of that subcontractor does not appear at the time set.

- c. The Escrow Bid Documentation will be returned to Contractor at such time as the Contract has been completed and final settlement has been achieved.

END OF DOCUMENT

ESCROW AGREEMENT IN LIEU OF RETENTION
(Public Contract Code Section 22300)

(Note: Contractor must use this form.)

This Escrow Agreement in Lieu of Retention ("Escrow Agreement") is made and entered into this _____ day of _____, 20____, by and between the Sacramento City Unified School District ("District"), whose address is 5735 47th Avenue, Sacramento, California 95824, and _____ ("Contractor"), whose address is _____, and _____ ("Escrow Agent"), a state or federally chartered bank in the state of California, whose address is _____.

For the consideration hereinafter set forth, District, Contractor, and Escrow Agent agree as follows:

- 22. Pursuant to section 22300 of Public Contract Code of the State of California, which is hereby incorporated by reference, Contractor has the following two (2) options:
 - Deposit securities with Escrow Agent as a substitute for retention earnings required to be withheld by District pursuant to the Construction Contract No.____ entered into between District and Contractor for the _____ Project, in the amount of _____ Dollars (\$_____) dated, _____, 20____, (the "Contract"); **or**
 - On written request of Contractor, District shall make payments of the retention earnings for the above referenced Contract directly to Escrow Agent.

When Contractor deposits the securities as a substitute for Contract earnings (first option), Escrow Agent shall notify District within ten (10) calendar days of the deposit. The market value of the securities at the time of substitution and at all times from substitution until the termination of the Escrow Agreement shall be at least equal to the cash amount then required to be withheld as retention under the terms of the Contract between District and Contractor.

Securities shall be held in the name of Sacramento City Unified School District, and shall designate Contractor as beneficial owner.

- 23. District shall make progress payments to Contractor for those funds which otherwise would be withheld from progress payments pursuant to Contract provisions, provided that Escrow Agent holds securities in form and amount specified above.
- 24. When District makes payment of retentions earned directly to Escrow Agent, Escrow Agent shall hold them for the benefit of Contractor until the time that the escrow created under this Escrow Agreement is terminated. Contractor may direct the investment of the payments into securities. All terms and conditions of this Escrow Agreement and the rights and responsibilities of the Parties shall be equally applicable and binding when District pays Escrow Agent directly.

25. Contractor shall be responsible for paying all fees for the expenses incurred by Escrow Agent in administering the Escrow Account, and all expenses of District. The District will charge Contractor \$_____ for each of District's deposits to the escrow account. These expenses and payment terms shall be determined by District, Contractor, and Escrow Agent.
26. Interest earned on securities or money market accounts held in escrow and all interest earned on that interest shall be for sole account of Contractor and shall be subject to withdrawal by Contractor at any time and from time to time without notice to District.
27. Contractor shall have the right to withdraw all or any part of the principal in the Escrow Account only by written notice to Escrow Agent accompanied by written authorization from District to Escrow Agent that District consents to withdrawal of amount sought to be withdrawn by Contractor.
28. District shall have the right to draw upon the securities and/or withdraw amounts from the Escrow Account in the event of default by Contractor. Upon seven (7) days' written notice to Escrow Agent from District of the default, if applicable, Escrow Agent shall immediately convert the securities to cash and shall distribute the cash as instructed by District. Escrow Agent shall not be authorized to determine the validity of any notice of default given by District pursuant to this paragraph, and shall promptly comply with District's instructions to pay over said escrowed assets. Escrow Agent further agrees to not interplead the escrowed assets in response to a conflicting demand.
29. Upon receipt of written notification from District certifying that the Contract is final and complete, and that Contractor has complied with all requirements and procedures applicable to the Contract, Escrow Agent shall release to Contractor all securities and interest on deposit less escrow fees and charges of the Escrow Account. The escrow shall be closed immediately upon disbursement of all monies and securities on deposit and payments of fees and charges.
30. Escrow Agent shall rely on written notifications from District and Contractor pursuant to Paragraphs 5 through 8, inclusive, of this Escrow Agreement and District and Contractor shall hold Escrow Agent harmless from Escrow Agent's release and disbursement of securities and interest as set forth above.

[REMAINDER OF PAGE INTENTIONALLY LEFT BLANK]

31. Names of persons who are authorized to give written notice or to receive written notice on behalf of District and on behalf of Contractor in connection with the foregoing, and exemplars of their respective signatures are as follows:

On behalf of District:

Title

Name

Signature

Address

On behalf of Contractor:

Title

Name

Signature

Address

On behalf of Escrow Agent:

Title

Name

Signature

Address

At the time that the Escrow Account is opened, District and Contractor shall deliver to Escrow Agent a fully executed copy of this Agreement.

IN WITNESS WHEREOF, the parties have executed this Agreement by their proper officers on the date first set forth above.

On behalf of District:

Title

Name

Signature

Address

On behalf of Contractor:

Title

Name

Signature

Address

END OF DOCUMENT

PERFORMANCE BOND
(100% of Contract Price)

(Note: Contractor must use this form, NOT a surety company form.)

KNOW ALL PERSONS BY THESE PRESENTS:

WHEREAS, the governing board ("Board") of the Sacramento City Unified School District, ("District") and _____ ("Principal") have entered into a contract for the furnishing of all materials and labor, services and transportation, necessary, convenient, and proper to perform the following project:

262-461-CBW-D-M - Clayton B. Wire Deferred Maintenance Project

("Project" or "Contract") which Contract dated _____, 20____, and all of the Contract Documents attached to or forming a part of the Contract, are hereby referred to and made a part hereof; and

WHEREAS, said Principal is required under the terms of the Contract to furnish a bond for the faithful performance of the Contract.

NOW, THEREFORE, the Principal and _____ ("Surety") are held and firmly bound unto the Board of the District in the penal sum of

_____ Dollars (\$_____), lawful money of the United States, for the payment of which sum well and truly to be made we bind ourselves, our heirs, executors, administrators, successors, and assigns jointly and severally, firmly by these presents, to:

- Promptly perform all the work required to complete the Project; and
- Pay to the District all damages the District incurs as a result of the Principal's failure to perform all the Work required to complete the Project.

Or, at the District's sole discretion and election, the Surety shall obtain a bid or bids for completing the Contract in accordance with its terms and conditions, and upon determination by the District of the lowest responsible bidder, arrange for a contract between such bidder and the District and make available as Work progresses sufficient funds to pay the cost of completion less the "balance of the Contract Price," and to pay and perform all obligations of Principals under the Contract, including, without limitation, all obligations with respect to warranties, guarantees and the payment of liquidated damages. The term "balance of the Contract Price," as used in this paragraph, shall mean the total amount payable to Principal by the District under the Contract and any modifications thereto, less the amount previously paid by the District to the Principal, less any withholdings by the District allowed under the Contract. District shall not be required or obligated to accept a tender of a completion contractor from the Surety for any or no reason.

The condition of the obligation is such that, if the above bound Principal, its heirs, executors, administrators, successors, or assigns, shall in all things stand to and abide by, and well and truly

keep and perform the covenants, conditions, and agreements in the Contract and any alteration thereof made as therein provided, on its part to be kept and performed at the time and in the intent and meaning, including all contractual guarantees and warranties of materials and workmanship, and shall indemnify and save harmless the District, its trustees, officers and agents, as therein stipulated, then this obligation shall become null and void, otherwise it shall be and remain in full force and virtue.

Surety expressly agrees that the District may reject any contractor or subcontractor proposed by Surety to fulfill its obligations in the event of default by the Principal. Surety shall not utilize Principal in completing the Work nor shall Surety accept a Bid from Principal for completion of the Work if the District declares the Principal to be in default and notifies Surety of the District's objection to Principal's further participation in the completion of the Work.

As a condition precedent to the satisfactory completion of the Contract, the above obligation shall hold good for a period equal to the warranty and/or guarantee period of the Contract, during which time Surety's obligation shall continue if Contractor shall fail to make full, complete, and satisfactory repair and replacements and totally protect the District from loss or damage resulting from or caused by defective materials or faulty workmanship. The obligations of Surety hereunder shall continue so long as any obligation of Contractor remains. Nothing herein shall limit the District's rights or the Contractor or Surety's obligations under the Contract, law or equity, including, but not limited to, California Code of Civil Procedure section 337.15.

The Surety, for value received, hereby stipulates and agrees that no change, extension of time, alteration, or addition to the terms of the contract or to the work to be performed thereunder or the specifications accompanying the same shall in any way affect its obligation on this bond. The Surety also stipulates and agrees that it shall not be exonerated or released from the obligation of this bond by any overpayment or underpayment by the District that is based upon estimates approved by the Architect. The Surety does hereby waive notice of any such change, extension of time, alteration, or addition to the terms of the Contract or to the work or to the specifications.

IN WITNESS WHEREOF, two (2) identical counterparts of this instrument, each of which shall for all purposes be deemed an original thereof, have been duly executed by the Principal and Surety above named, on the _____ day of _____, 20__.

_____	_____
Principal	Surety
_____	_____
By	By

	Name of California Agent of Surety

	Address of California Agent of Surety

	Telephone No. of California Agent of Surety

Contractor must attach a Notarial Acknowledgment for all Surety's signatures and a Power of Attorney and Certificate of Authority for Surety. The California Department of Insurance must authorize the Surety to be an admitted surety insurer.
END OF DOCUMENT

PAYMENT BOND
Contractor's Labor & Material Bond
(100% Of Contract Price)

(Note: Contractor must use this form, NOT a surety company form.)

KNOW ALL PERSONS BY THESE PRESENTS:

WHEREAS, the governing board ("Board") of the Sacramento City Unified School District, ("District") and _____, ("Principal") have entered into a contract for the furnishing of all materials and labor, services and transportation, necessary, convenient, and proper to perform the following project:

262-461-CBW-D-M - Clayton B. Wire Deferred Maintenance Project

("Project" or "Contract") which Contract dated _____, 20____, and all of the Contract Documents attached to or forming a part of the Contract, are hereby referred to and made a part hereof; and

WHEREAS, pursuant to law and the Contract, the Principal is required, before entering upon the performance of the work, to file a good and sufficient bond with the body by which the Contract is awarded in an amount equal to one hundred percent (100%) of the Contract price, to secure the claims to which reference is made in sections 9000 through 9510 and 9550 through 9566 of the Civil Code, and division 2, part 7, of the Labor Code.

NOW, THEREFORE, the Principal and _____ ("Surety") are held and firmly bound unto all laborers, material men, and other persons referred to in said statutes in the sum of _____ Dollars (\$_____), lawful money of the United States, being a sum not less than the total amount payable by the terms of Contract, for the payment of which sum well and truly to be made, we bind ourselves, our heirs, executors, administrators, successors, or assigns, jointly and severally, by these presents.

The condition of this obligation is that if the Principal or any of its subcontractors, or their heirs, executors, administrators, successors, or assigns of any, all, or either of them shall fail to pay for any labor, materials, provisions, or other supplies, used in, upon, for or about the performance of the work contracted to be done, or for any work or labor thereon of any kind, or for amounts required to be deducted, withheld, and paid over to the Employment Development Department from the wages of employees of the Principal or any of his or its subcontractors of any tier under Section 13020 of the Unemployment Insurance Code with respect to such work or labor, that the Surety will pay the same in an amount not exceeding the amount herein above set forth, and also in case suit is brought upon this bond, will pay a reasonable attorney's fee to be awarded and fixed by the court, and to be taxed as costs and to be included in the judgment therein rendered.

It is hereby expressly stipulated and agreed that this bond shall inure to the benefit of any and all persons, companies, and corporations entitled to file claims under section 9100 of

the Civil Code, so as to give a right of action to them or their assigns in any suit brought upon this bond.

Should the condition of this bond be fully performed, then this obligation shall become null and void; otherwise it shall be and remain in full force and affect.

And the Surety, for value received, hereby stipulates and agrees that no change, extension of time, alteration, or addition to the terms of Contract or the specifications accompanying the same shall in any manner affect its obligations on this bond, and it does hereby waive notice of any such change, extension, alteration, or addition.

IN WITNESS WHEREOF, two (2) identical counterparts of this instrument, each of which shall for all purposes be deemed an original thereof, have been duly executed by the Principal and Surety above named, on the _____ day of _____, 20__.

_____	_____
Principal	Surety
_____	_____
By	By

	Name of California Agent of Surety

	Address of California Agent of Surety

	Telephone No. of California Agent of Surety

Contractor must attach a Notarial Acknowledgment for all Surety's signatures and a Power of Attorney and Certificate of Authority for Surety. The California Department of Insurance must authorize the Surety to be an admitted surety insurer.

END OF DOCUMENT

ALLOWANCE EXPENDITURE DIRECTIVE FORM

ALLOWANCE EXPENDITURE DIRECTIVE

Sacramento City Unified School District
 5735 47th Avenue
 Sacramento, CA 95824

ALLOWANCE EXPENDITURE DIRECTIVE NO.:

Contractor Name:

**Project: Clayton B. Wire Deferred Maintenance
 Project**

Date: _____
 DSA File No. N/A
 DSA Appl. No. N/A

Bid No.: 262-461-CBW-D-M

The named parties agree to the terms of this Allowance Expenditure Directive ("AED"):

Reference	Description	Allowance Authorized for Expenditure
Request for AED #	PCO# XX [Description of unforeseen item relating to Work]	\$
Requested by:	[Contractor Name]	
Performed by:	[GC or Sub]	
Reason:	[RFI#, CCD#, ASI# etc.]	

Total Contract Allowance Amount:	\$
Amount of Previously Approved Allowance Expenditure Directive(s):	\$
Amount of this Allowance Expenditure Directive:	\$

The undersigned Contractor approves the foregoing release of allowance for completion of each specified item, and agrees to furnish all labor, materials and services and perform all work necessary to complete any additional work specified for the consideration stated therein ("Work"). Submission of sums which have no basis in fact or which Contractor knows are false are at the sole risk of Contractor and may be a violation of the False Claims Act set forth under Government Code section 12650, et seq.

This Allowance Expenditure Directive must be signed by an authorized District representative.

**SACRAMENTO CITY USD
 0262-461-CBW-D-M Clayton B. Wire
 Deferred Maintenance**

**ALLOWANCE EXPENDITURE DIRECTIVE
 DOCUMENT 00 63 40-1**

It is expressly understood that the authorized allowance expenditure granted herein represents a full accord and satisfaction for any and all cost impacts of the items herein, and Contractor waives any and all further compensation based on the items herein. The value of the extra work or changes expressly includes any and all of the Contractor's costs and expenses, and its subcontractors, both direct and indirect. Any costs, expenses, or damages not included are deemed waived.

Signatures:

<p>CONTRACTOR:</p> <p>Date: _____</p> <p>By: _____ [Print Name and Title here]</p>	<p>CONSTRUCTION MANAGER:</p> <p>_____</p> <p>Date: _____</p> <p>By: _____ [Print Name and Title here]</p>
<p>SCUSD MANAGER III, FACILITIES PM:</p> <p>Date: _____</p> <p>By: _____ [Print Name and Title here]</p>	<p>SCUSD DIRECTOR III FACILITIES MGMT:</p> <p>Date: _____</p> <p>By: _____ [Print Name and Title here]</p>

END OF DOCUMENT

DAILY FORCE ACCOUNT REPORT

From: Contractor
[Name/Address]

To: Owner
[Name/Address]

Project: 262-461-CBW-D-M Clayton B. Wire Deferred Maintenance Project

Contractor hereby submits this Daily Force Account Report for Work performed, pursuant to Force Account Directive No. _____, on _____.
[Date of Work]

Contractor attests that the material, labor, and equipment itemized herein were used only on the force account work.

A. Material: *Attach all applicable invoices not provided in prior Daily Force Account Reports and complete the information below.*

Description	Unit Price	Quantity	Cost

Daily subtotal (w/out markup): \$ _____

B. Labor: *Labor must be fully Burdened. Attach timesheets, if applicable, and complete the information below.*

Name	Craft	Regular Hrs.	Rate	OT Hrs.	Rate

Daily subtotal (w/out markup): \$ _____

C. **Equipment:** Attach all applicable invoices not provided in prior Daily Force Account Reports and complete the information below.

Type / Model	Hrs. Operated	Rate

Daily subtotal (w/out markup): \$ _____

Complete based on information reported above.

	<u>WORK PERFORMED OTHER THAN BY CONTRACTOR</u>	<u>ADD</u>
(a)	<u>Material</u>	
(b)	<u>Add Labor</u>	
(c)	<u>Add Equipment</u>	
(d)	<u>Subtotal</u>	
(e)	<u>Add overhead and profit for any and all tiers of Subcontractor</u> , the total not to exceed ten percent (10%) of Item (d)	
(f)	<u>Subtotal</u>	
(g)	<u>Add Overhead and Profit for Contractor</u> , not to exceed five percent (5%) of Item (f)	
(h)	<u>Subtotal</u>	
(i)	<u>Add Bond and Insurance</u> , not to exceed two percent (2%) of Item (h)	
(j)	<u>TOTAL</u>	

	<u>WORK PERFORMED BY CONTRACTOR</u>	<u>ADD</u>
(a)	<u>Material</u>	
(b)	<u>Add Labor</u>	
(c)	<u>Add Equipment</u>	
(d)	<u>Subtotal</u>	
(e)	<u>Add Overhead and Profit for Contractor</u> , not to exceed fifteen percent (15%) of Item (d)	
(f)	<u>Subtotal</u>	
(g)	<u>Add Bond and Insurance</u> , not to exceed two percent (2%) of Item (f)	
(h)	<u>TOTAL</u>	

Submission of sums which have no basis in fact or which Contractor knows are false are at the sole risk of Contractor and may be a violation of the False Claims Act (Gov. Code, § 12650 et seq.).

It is expressly understood that all force account work for the date stated above must be reported herein, and Contractor may not claim any labor, equipment, material or any other costs or expenses not reported herein. Contractor is not entitled to separately recover amounts for overhead or other indirect costs. Any costs, expenses, or damages not included are deemed waived.

SUBMITTED BY:

REVIEWED BY:

Contractor:

District:

[Name]

Date

[Name]

Date

District may require additional information from Contractor to review this Daily Force Account Report. Upon District's return of the Daily Force Account Report, Contractor may invoice the Work reflected therein. District's review and return of the Daily Force Account Report and/or payment for the force account work does not constitute acceptance of the Work or waiver of any Contract rights or criteria.

END OF DOCUMENT

PROPOSED CHANGE ORDER FORM

Sacramento City Unified School District
 5735 47th Avenue
 Sacramento, CA 95824

PCO NO.:

Project: Clayton B. Wire Deferred Maintenance Project
Bid No.: 262-461-CBW-D-M
RFI #: _____

Date: _____
DSA File No.: N/A
DSA Appl. No.: N/A

Contractor hereby submits for District’s review and evaluation this Proposed Change Order (“PCO”), submitted in accordance with and subject to the terms of the Contract Documents, including Sections 17.7 and 17.8 of the General Conditions. Any spaces left blank below are deemed no change to cost or time.

Contractor understands and acknowledges that documentation supporting Contractor’s PCO must be attached and included for District review and evaluation. Contractor further understands and acknowledges that failure to include documentation sufficient to, in District’s discretion, support some or all of the PCO, shall result in a rejected PCO.

	<u>WORK PERFORMED OTHER THAN BY CONTRACTOR</u>	<u>ADD</u>	<u>DEDUCT</u>
(i)	<u>Material</u> (attach suppliers’ invoice or itemized quantity and unit cost plus sales tax)		
(j)	<u>Add Labor</u> (attach itemized hours and rates, fully Burdened, and specify the hourly rate for each additional labor burden, for example, payroll taxes, fringe benefits, etc.)		
(k)	<u>Add Equipment</u> (attach suppliers’ invoice)		
(l)	<u>Subtotal</u>		
(m)	<u>Add overhead and profit for any and all tiers of Subcontractor</u> , the total not to exceed ten percent (10%) of Item (d)		
(n)	<u>Subtotal</u>		
(o)	<u>Add General Conditions</u> (if Time is Compensable) (attach supporting documentation)		
(p)	<u>Subtotal</u>		
(q)	<u>Add Overhead and Profit for Contractor</u> , not to exceed five percent (5%) of Item (h)		
(r)	<u>Subtotal</u>		
(s)	<u>Add Bond and Insurance</u> , not to exceed two percent (2%) of Item (j) If PCO exceeds Allowance ONLY		
(t)	<u>TOTAL</u>		
(u)	<u>Time</u> (zero unless indicated; “TBD” not permitted)	____ Calendar Days	

[REMAINDER OF PAGE LEFT BLANK INTENTIONALLY]

	WORK PERFORMED BY CONTRACTOR	ADD	DEDUCT
(v)	Material (attach itemized quantity and unit cost plus sales tax)		
(w)	Add Labor (attach itemized hours and rates, fully Burdened, and specify the hourly rate for each additional labor burden, for example, payroll taxes, fringe benefits, etc.)		
(x)	Add Equipment (attach suppliers' invoice)		
(y)	Add General Conditions (if Time is Compensable) (attach supporting documentation)		
(z)	Subtotal		
(aa)	Add Overhead and Profit for Contractor , not to exceed fifteen percent (15%) of Item (e)		
(bb)	Subtotal		
(cc)	Add Bond and Insurance , not to exceed two percent (2%) of Item (g) If PCO exceeds Allowance ONLY		
(dd)	TOTAL		
(ee)	Time (zero unless indicated; "TBD" not permitted)	_____ Calendar Days	

The undersigned Contractor approves the foregoing as to the changes, if any, to the Contract Price specified for each item, and as to the extension of time allowed, if any, for completion of the entire Work as stated herein, and agrees to furnish all labor, materials, and service, and perform all work necessary to complete any additional work specified for the consideration stated herein. Submission of sums which have no basis in fact or which Contractor knows are false are at the sole risk of Contractor and may be a violation of the False Claims Act set forth under Government Code section 12650 et seq. It is understood that the changes herein to the Contract shall only be effective when approved by the governing board of the District.

It is expressly understood that the value of the extra Work or changes expressly includes any and all of the Contractor's costs and expenses, direct and indirect, resulting from additional time required on the Project or resulting from delay to the Project including, without limitation, cumulative impacts. Contractor is not entitled to separately recover amounts for overhead or other indirect costs. Any costs, expenses, damages, or time extensions not included are deemed waived.

SUBMITTED BY:

Contractor:

[Name]

Date

END OF DOCUMENT

CHANGE ORDER FORM

Sacramento City Unified School District
 5735 47th Avenue
 Sacramento, CA 95824

CHANGE ORDER NO.:

CHANGE ORDER

Project: Clayton B. Wire Deferred Maintenance Project
Bid No.: 262-461-CBW-D-M

Date: _____
DSA File No.: N/A
DSA Appl. No.: N/A

The following parties agree to the terms of this Change Order:

Owner: _____
 [Name / Address]

Contractor: _____
 [Name / Address]

Architect: _____
 [Name / Address]

Project Inspector: _____
 [Name / Address]

Reference	Description	Cost	Days Ext.
PCO # Requested by: Performed by: Reason:	[Description of change] [Requester] [Performer] [Reason]	\$	
PCO # Requested by: Performed by: Reason:	[Description of change] [Requester] [Performer] [Reason]	\$	
PCO # Requested by: Performed by: Reason:	[Description of change] [Requester] [Performer] [Reason]	\$	
Contract time will be adjusted as follows: Previous Completion Date: __[Date] _____[#] Calendar Days Extension (zero unless otherwise indicated) Current Completion Date: __[Date]		Original Contract Amount:	\$
		Amount of Previously Approved Change Order(s):	\$
		Amount of this Change Order:	\$
		Contract Amount:	\$

AGREEMENT AND RELEASE OF ANY AND ALL CLAIMS

THIS AGREEMENT AND RELEASE OF CLAIMS ("Agreement and Release") IS MADE AND ENTERED INTO THIS _____ DAY OF _____, 20__ by and between the SACRAMENTO CITY UNIFIED SCHOOL DISTRICT ("District") and _____ ("Contractor"), whose place of business is _____.

RECITALS

WHEREAS, District and Contractor entered into PROJECT/CONTRACT NO.: _____ ("Contract" or "Project") in the County of Sacramento, California; and

WHEREAS, the Work under the Contract was completed on _____, and a Notice of Completion was recorded with the County Recorder on _____.

NOW, THEREFORE, it is mutually agreed between District and Contractor as follows:

AGREEMENT AND RELEASE

1. Contractor will only be assessed liquidated damages as detailed below:

- Original Contract Sum \$ _____
- Modified Contract Sum \$ _____
- Payment to Date \$ _____
- Liquidated Damages \$ _____
- Payment Due Contractor \$ _____

2. Subject to the provisions hereof, District shall forthwith pay to Contractor the undisputed sum of _____ Dollars (\$ _____) under the Contract, less any amounts represented by any notice to withhold funds on file with District as of the date of such payment.

3. Contractor acknowledges and hereby agrees that there are no unresolved or outstanding claims in dispute against District arising from the performance of work under the Contract, except for the claims described in Paragraph 4 and continuing obligations described in Paragraph 6. It is the intention of the parties in executing this Agreement and Release that this Agreement and Release shall be effective as a full, final and general release of all claims, demands, actions, causes of action, obligations, costs, expenses, damages, losses and liabilities of Contractor against District and all of its respective agents, employees, trustees, inspectors, assignees, consultants and transferees, except for any Disputed Claim that may be set forth in Paragraph 4 and the continuing obligations described in Paragraph 6 hereof.

4. The following claims are disputed (hereinafter, the "Disputed Claims") and are specifically excluded from the operation of this Agreement and Release:

<u>Claim No.</u>	<u>Description of Claim</u>	<u>Amount of Claim</u>	<u>Date Claim Submitted</u>
_____	_____	\$ _____	_____
_____	_____	\$ _____	_____
_____	_____	\$ _____	_____
_____	_____	\$ _____	_____
_____	_____	\$ _____	_____
_____	_____	\$ _____	_____

[If further space is required, attach additional sheets showing the required information.]

5. Consistent with California Public Contract Code section 7100, Contractor hereby agrees that, in consideration of the payment set forth in Paragraph 2 hereof, Contractor hereby releases and forever discharges District, all its agents, employees, inspectors, assignees, and transferees from any and all liability, claims, demands, actions, or causes of action of whatever kind or nature arising out of or in any way concerned with the Work under the Contract.
6. Guarantees and warranties for the Work, and any other continuing obligation of Contractor, including without limitation, the duty to defend, indemnify and hold harmless the District, shall remain in full force and effect as specified in the Contract Documents.
7. Contractor hereby waives the provisions of California Civil Code section 1542 which provides as follows:
- A GENERAL RELEASE DOES NOT EXTEND TO CLAIMS THAT THE CREDITOR OR RELEASING PARTY DOES NOT KNOW OR SUSPECT TO EXIST IN HIS OR HER FAVOR AT THE TIME OF EXECUTING THE RELEASE AND THAT, IF KNOWN BY HIM OR HER, WOULD HAVE MATERIALLY AFFECTED HIS OR HER SETTLEMENT WITH THE DEBTOR OR RELEASED PARTY.
8. The provisions of this Agreement and Release are contractual in nature and not mere recitals and shall be considered independent and severable. If any such provision or any part thereof shall be at any time held invalid in whole or in part under any federal, state, county, municipal, or other law, ruling, or regulations, then such provision, or part thereof, shall remain in force and effect to the extent permitted by law, and the remaining provisions of this Agreement and Release shall also remain in full force and effect, and shall be enforceable.

9. All rights of District shall survive completion of the Work or termination of Contract, and execution of this Release.

* * * CAUTION: THIS IS A RELEASE - READ BEFORE EXECUTING * * *

SACRAMENTO CITY UNIFIED SCHOOL DISTRICT

Signature: _____

Print Name: _____

Title: _____

CONTRACTOR: _____

Signature: _____

Print Name: _____

Title: _____

END OF DOCUMENT

GUARANTEE FORM
(Print on Contractor/Subcontractor Letterhead)

_____ **[Contractor's Name]** hereby unconditionally guarantees that the Work performed at **262-461-CBW-D-M Clayton B. Wire Deferred Maintenance Project** has been done in accordance with the requirements of the Contract therefore and further guarantees the Work of the contract to be and remain free of defects in workmanship and materials for a period of **two (2) years** from and after the recordation of the Notice of Completion of the Project and completion of all Contract obligations by the Contractor, including formal acceptance of the entire Project by the District, unless a longer guarantee period is called for by the Contract Documents, in which case the terms of the longer guarantee shall govern. The Contractor specifically waives any right to claim or rely on the statutory definition of completion set forth in Civil Code section 9200. The Contractor specifically acknowledges and agrees that completion shall mean the Contractor's complete performance of all Work required by the Contract Documents, amendments, change orders, construction change directives and punch lists, and the District's formal acceptance of the entire Project, without regard to prior occupancy, substantial completion doctrine, beneficial occupancy, or otherwise. The Contractor hereby agrees to repair or replace any and all Work, together with any adjacent Work which may have been damaged or displaced in so doing, that may prove to be not in accordance with the requirements of the Contract or that may be defective in its workmanship or materials within the guarantee period specified, without any expense whatsoever to the District, ordinary wear and tear and unusual abuse and neglect only excepted. The Contractor has provided contract bonds, which will remain in full force and effect during the guarantee period.

The Contractor further agrees that within ten (10) calendar days after being notified in writing by the District of any Work not in accordance with the requirements of the contract or any defects in the Work, it will commence and prosecute with due diligence all Work necessary to fulfill the terms of this guarantee, and to complete the Work within a period of time stipulated in writing. In the event it fails to so comply, Contractor does hereby authorize the District to proceed to have such Work done at the Contractor's expense and it will pay the cost thereof upon demand. The District shall be entitled to all costs, including reasonable attorneys' fees, necessarily incurred upon the Contractor's refusal to pay the above costs.

The guarantee period for corrected defective work shall continue for a duration equivalent to the original guarantee period.

Notwithstanding the foregoing paragraph, in the event of an emergency constituting an immediate hazard to the health or safety of the employees of the District, or its property or licensees, the District may undertake at the Contractor's expense without prior notice, all Work necessary to correct such hazardous condition when it was caused by the Work of the Contractor not being in accordance with the requirements of this contract, or being defective, and to charge the same to the Contractor as specified in the preceding paragraph.

The guarantee set forth herein is not intended by the parties, not shall it be construed, as in any way limiting or reducing the District's rights to enforce all terms of the Contract referenced hereinabove or the time for enforcement thereof. This guarantee is provided in addition to, and not in lieu of, the District's rights on such contract.

_____ Spec Section(s): _____
CONTRACTOR'S SIGNATURE

PRINT NAME

TABLE OF CONTENTS

	<u>Page</u>
1. CONTRACT TERMS AND DEFINITIONS	1
1.1 Definitions.....	1
1.2 Laws Concerning the Contract.....	6
1.3 No Oral Agreements	7
1.4 No Assignment.....	7
1.5 Notice and Service Thereof	7
1.6 No Waiver	7
1.7 Substitutions for Specified Items.....	8
1.8 Materials and Work.....	9
2. [RESERVED]	11
3. ARCHITECT	11
4. CONSTRUCTION MANAGER.....	12
5. INSPECTOR, INSPECTIONS, AND TESTS.....	12
5.1 Project Inspector.....	12
5.2 Tests and Inspections	13
5.3 Costs for After Hours and/or Off Site Inspections	13
6. CONTRACTOR	13
6.1 Status of Contractor	14
6.2 Project Inspection Card(s)	15
6.3 Contractor’s Supervision	15
6.4 Duty to Provide Fit Workers.....	15
6.5 Field Office	16
6.6 Purchase of Materials and Equipment.....	16

6.7	Documents on Work	16
6.8	Preservation of Records	17
6.9	Integration of Work	17
6.10	Notifications	18
6.11	Obtaining of Permits, Licenses and Registrations	18
6.12	Royalties and Patents	19
6.13	Work to Comply With Applicable Laws and Regulations	20
6.14	Safety/Protection of Persons and Property	21
6.15	Working Evenings and Weekends	23
6.16	Cleaning Up.....	23
7.	SUBCONTRACTORS	24
8.	OTHER CONTRACTS/CONTRACTORS	26
9.	DRAWINGS AND SPECIFICATIONS	27
10.	CONTRACTOR'S SUBMITTALS AND SCHEDULES	28
10.1	Schedule of Work, Schedule of Submittals, and Schedule of Values	28
10.2	Monthly Progress Schedule(s).....	31
10.3	Material Safety Data Sheets (MSDS).....	31
11.	SITE ACCESS, CONDITIONS, AND REQUIREMENTS	32
11.1	Site Investigation	32
11.2	Soils Investigation Report.....	32
11.3	Access to Work	33
11.4	Layout and Field Engineering	33
11.5	Utilities	33
11.6	Sanitary Facilities	33
11.7	Surveys	33
11.8	Regional Notification Center.....	33
11.9	Existing Utility Lines	34

11.10	Notification.....	34
11.11	Hazardous Materials	35
11.12	No Signs	35
12.	TRENCHES	35
12.1	Trenches Greater Than Five Feet.....	35
12.2	Excavation Safety	35
12.3	No Tort Liability of District.....	35
12.4	No Excavation without Permits.....	35
12.5	Discovery of Hazardous Waste and/or Unusual Conditions	35
13.	INSURANCE AND BONDS	36
13.1	Insurance.....	36
13.2	Contract Security - Bonds	41
14.	WARRANTY/GUARANTEE/INDEMNITY.....	41
14.1	Warranty/Guarantee.....	41
14.2	Indemnity and Defense	42
15.	TIME.....	44
15.1	Notice to Proceed	44
15.2	Computation of Time / Adverse Weather	44
15.3	Hours of Work	45
15.4	Progress and Completion.....	46
15.5	Schedule	46
15.6	Expeditious Completion	46
16.	EXTENSIONS OF TIME – LIQUIDATED DAMAGES	46
16.1	Liquidated Damages	46
16.2	Excusable Delay	46
16.3	No Additional Compensation for Delays Within Contractor’s Control	47
16.4	Float or Slack in the Schedule	48

17.	CHANGES IN THE WORK	48
17.1	No Changes Without Authorization	48
17.2	Architect Authority	49
17.3	Change Orders.....	49
17.4	Construction Change Directives.....	50
17.5	Force Account Directives	50
17.6	Price Request.....	51
17.7	Proposed Change Order	51
17.8	Format for Proposed Change Order.....	54
17.9	Change Order Certification	56
17.10	Determination of Change Order Cost	57
17.11	Deductive Change Orders.....	57
17.12	Addition or Deletion of Alternate Bid Item(s)	57
17.13	Discounts, Rebates, and Refunds	58
17.14	Accounting Records	58
17.15	Notice Required	58
17.16	Applicability to Subcontractors	58
17.17	Alteration to Change Order Language	58
17.18	Failure of Contractor to Execute Change Order.....	59
18.	REQUEST FOR INFORMATION	59
19.	PAYMENTS	59
19.1	Contract Price	59
19.2	Applications for Progress Payments	59
19.3	Progress Payments	62
19.4	Decisions to Withhold Payment	64
19.5	Subcontractor Payments	66
20.	COMPLETION OF THE WORK.....	67

20.1	Completion.....	67
20.2	Close-Out/Certification Procedures	67
20.3	Final Inspection	68
20.4	Costs of Multiple Inspections.....	70
20.5	Partial Occupancy or Use Prior to Completion.....	70
21.	FINAL PAYMENT AND RETENTION.....	70
21.1	Final Payment.....	70
21.2	Prerequisites for Final Payment	71
21.3	Retention	71
21.4	Substitution of Securities	72
22.	UNCOVERING OF WORK.....	72
23.	NONCONFORMING WORK AND CORRECTION OF WORK	72
23.1	Nonconforming Work	72
23.2	Correction of Work	72
23.3	District's Right to Perform Work	73
24.	TERMINATION AND SUSPENSION.....	74
24.1	District’s Request for Assurances.....	74
24.2	District's Right to Terminate Contractor for Cause	74
24.3	Termination of Contractor for Convenience.....	75
24.4	Effect of Termination	76
24.5	Emergency Termination of Public Contracts Act of 1949	77
24.6	Suspension of Work.....	77
25.	CLAIMS PROCESS	78
25.1	Obligation to File Claims for Disputed Work	78
25.2	Duty to Perform during Claim Process	78
25.3	Definition of Claim.....	78
25.4	Claims Presentation	79

25.5	Claim Resolution pursuant to Public Contract Code section 9204	80
25.6	Subcontractor Pass-Through Claims.....	82
25.7	Government Code Claim Act Claim	82
25.8	Claim Resolution pursuant to Public Contract Code section 20104 et seq.....	83
25.9	Claim Procedure Compliance.....	84
25.10	Claim Resolution Non-Applicability.....	85
25.11	Attorney’s Fees	85
26.	STATE LABOR, WAGE & HOUR, APPRENTICE, AND RELATED PROVISIONS	85
26.1	Labor Compliance and Enforcement.....	85
26.2	Wage Rates, Travel, and Subsistence.....	85
26.3	Hours of Work	87
26.4	Payroll Records	87
26.5	[RESERVED]	88
26.6	Apprentices	88
26.7	Non-Discrimination.....	90
26.8	Labor First Aid	90
27.	[RESERVED]	90
28.	MISCELLANEOUS	90
28.1	Assignment of Antitrust Actions	90
28.2	Excise Taxes.....	91
28.3	Taxes	91
28.4	Shipments.....	92
28.5	Compliance with Government Reporting Requirements	92

GENERAL CONDITIONS

1. **CONTRACT TERMS AND DEFINITIONS**

1.1 Definitions

Wherever used in the Contract Documents, the following terms shall have the meanings indicated, which shall be applicable to both the singular and plural thereof:

1.1.1 Adverse Weather: Shall be only weather that satisfies all of the following conditions: (1) unusually severe precipitation, sleet, snow, hail, or extreme temperature conditions in excess of the norm for the location and time of year it occurred based on the closest weather station data averaged over the past five years, (2) that is unanticipated and would cause unsafe work conditions and/or is unsuitable for scheduled work that should not be performed during inclement weather (i.e., exterior finishes), and (3) at the Project.

1.1.2 Allowance Expenditure Directive: Written authorization for expenditure of allowance, if any.

1.1.3 Approval, Approved, and/or Accepted: Written authorization, unless stated otherwise.

1.1.4 Architect (or "Design Professional in General Responsible Charge"): The individual, partnership, corporation, joint venture, or any combination thereof, named as Architect, who will have the rights and authority assigned to the Architect in the Contract Documents. The term Architect means the Design Professional in General Responsible Charge as defined in DSA PR 13-02 on this Project or the Architect's authorized representative.

1.1.5 As-Builts: Reproducible blue line prints of drawings to be prepared on a monthly basis pursuant to the Contract Documents, that reflect changes made during the performance of the Work, recording differences between the original design of the Work and the Work as constructed since the preceding monthly submittal. See **Record Drawings**.

1.1.6 Bidder: A contractor who intends to provide a proposal to the District to perform the Work of this Contract.

1.1.7 Burdened: The labor rate for Contractor or any Subcontractor inclusive of any and all burden costs including, but not limited to, health and welfare pay, vacation and holiday pay, pension contributions, training rates, benefits of any kind, insurance of any kind, workers' compensation, liability insurance, truck expenses, supply expenses of any kind, payroll taxes, and any other taxes of any kind.

1.1.8 Change Order: A written order to the Contractor authorizing an addition to, deletion from, or revision in the Work, and/or authorizing an adjustment in the Contract Price or Contract Time.

1.1.9 Claim: A Dispute that remains unresolved at the conclusion of the all the applicable Dispute Resolution requirements provided herein.

1.1.10 Construction Change Directive: A written order prepared and issued by the District, the Construction Manager, and/or the Architect and signed by the District and the Architect, directing a change in the Work.

1.1.11 Construction Manager: The individual, partnership, corporation, joint venture, or any combination thereof, or its authorized representative, named as such by the District. If no Construction Manager is used on the Project that is the subject of this Contract, then all references to Construction Manager herein shall be read to refer to District.

1.1.12 Construction Schedule: The progress schedule of construction of the Project as provided by Contractor and approved by District.

1.1.13 Contract, Contract Documents: The Contract consists exclusively of the documents evidencing the agreement of the District and Contractor, identified as the Contract Documents. The Contract Documents consist of the following documents:

- 1.1.13.1** Notice to Bidders
- 1.1.13.2** Instructions to Bidders
- 1.1.13.3** Bid Form and Proposal
- 1.1.13.4** Bid Bond
- 1.1.13.5** Designated Subcontractors List
- 1.1.13.6** Site Visit Certification (if a site visit was required)
- 1.1.13.7** Non-Collusion Declaration
- 1.1.13.8** Notice of Award
- 1.1.13.9** Notice to Proceed
- 1.1.13.10** Agreement
- 1.1.13.11** Escrow of Bid Documentation
- 1.1.13.12** Escrow Agreement for Security Deposits in Lieu of Retention (if applicable)
- 1.1.13.13** Performance Bond
- 1.1.13.14** Payment Bond (Contractor's Labor & Material Bond)
- 1.1.13.15** General Conditions
- 1.1.13.16** Special Conditions (if applicable)
- 1.1.13.17** Project Labor Agreement (if applicable)
- 1.1.13.18** Hazardous Materials Procedures and Requirements
- 1.1.13.19** Workers' Compensation Certification
- 1.1.13.20** Prevailing Wage Certification
- 1.1.13.21** Disabled Veteran Business Enterprise Participation Certification (if applicable)
- 1.1.13.22** Drug-Free Workplace Certification (if applicable)
- 1.1.13.23** Tobacco-Free Environment Certification
- 1.1.13.24** Hazardous Materials Certification (if applicable)
- 1.1.13.25** Lead-Based Materials Certification (if applicable)
- 1.1.13.26** Imported Materials Certification (if applicable)
- 1.1.13.27** Criminal Background Investigation/Fingerprinting Certification
- 1.1.13.28** Buy American Certification (if certain federal funds used)
- 1.1.13.29** Roofing Project Certification (if applicable)

- 1.1.13.30** Registered Subcontractors List
- 1.1.13.31** Iran Contracting Act Certification (if applicable)
- 1.1.13.32** COVID-19 Vaccination/Testing Certification
- 1.1.13.33** Federal Debarment Certification (if applicable)
- 1.1.13.34** Federal Byrd Anti-Lobbying Certification (if applicable)
- 1.1.13.35** Post Bid Interview
- 1.1.13.36** All Plans, Technical Specifications, and Drawings
- 1.1.13.37** Any and all addenda to any of the above documents
- 1.1.13.38** Any and all change orders or written modifications to the above documents if approved in writing by the District

1.1.14 Contract Price: The total monies payable to the Contractor under the terms and conditions of the Contract Documents.

1.1.15 Contract Time: The time period stated in the Agreement for the completion of the Work.

1.1.16 Contractor: The person or persons identified in the Agreement as contracting to perform the Work to be done under this Contract, or the legal representative of such a person or persons.

1.1.17 Daily Job Report(s): Daily Project reports prepared by the Contractor's employee(s) who are present on Site, which shall include the information required herein.

1.1.18 Day(s): Unless otherwise designated, day(s) means calendar day(s).

1.1.19 Department of Industrial Relations (or "DIR"): is responsible, among other things, for labor compliance monitoring and enforcement of California prevailing wage laws and regulations for public works contracts.

1.1.20 Design Professional in General Responsible Charge: See definition of **Architect** above.

1.1.21 Dispute: A separate demand by Contractor for a time extension, or payment of money or damages arising from Work done by or on behalf of the Contractor pursuant to the Contract and payment of which is not otherwise expressly provided for or Contractor is not otherwise entitled to; or an amount of payment disputed by the District.

1.1.22 District: The public agency or the school district for which the Work is performed. The governing board of the District or its designees will act for the District in all matters pertaining to the Contract. The District may, at any time,

1.1.22.1 Direct the Contractor to communicate with or provide notice to the Construction Manager or the Architect on matters for which the Contract Documents indicate the Contractor will communicate with or provide notice to the District; and/or

1.1.22.2 Direct the Construction Manager or the Architect to communicate with or direct the Contractor on matters for which the Contract Documents indicate the District will communicate with or direct the Contractor.

1.1.23 Drawings (or "Plans"): The graphic and pictorial portions of the Contract Documents showing the design, location, scope and dimensions of the work, generally including plans, elevations, sections, details, schedules, sequence of operation, and diagrams.

1.1.24 DSA: Division of the State Architect.

1.1.25 Force Account Directive: A process that may be used when the District and the Contractor cannot agree on a price for a specific portion of work or before the Contractor prepares a price for a specific portion of work and whereby the Contractor performs the work as indicated herein on a time and materials basis.

1.1.26 Job Cost Reports: Any and all reports or records detailing the costs associated with work performed on or related to the Project that Contractor shall maintain for the Project. Specifically, Job Cost Reports shall contain, but are not limited by or to, the following information: a description of the work performed or to be performed on the Project; quantity, if applicable, of work performed (hours, square feet, cubic yards, pounds, etc.) for the Project; Project budget; costs for the Project to date; estimated costs to complete the Project; and expected costs at completion. The Job Cost Reports shall also reflect all Contract cost codes, change orders, elements of non-conforming work, back charges, and additional services.

1.1.27 Labor Commissioner's Office (or "Labor Commissioner", also known as the Division of Labor Standards Enforcement ("DLSE")): Division of the DIR responsible for adjudicating wage claims, investigating discrimination and public works complaints, and enforcing Labor Code statutes and Industrial Welfare Commission orders.

1.1.28 Municipal Separate Storm Sewer System (or "MS4"): A system of conveyances used to collect and/or convey storm water, including, without limitation, catch basins, curbs, gutters, ditches, man-made channels, and storm drains.

1.1.29 Plans: See **Drawings**.

1.1.30 Premises: The real property owned by the District on which the Site is located.

1.1.31 Product(s): New material, machinery, components, equipment, fixtures and systems forming the Work, including existing materials or components required and approved by the District for reuse.

1.1.32 Product Data: Illustrations, standard schedules, performance charts, instructions, brochures, diagrams, and other information furnished by the Contractor to illustrate a material, product, or system for some portion of the Work.

1.1.33 Program Manager: The individual, partnership, corporation, joint venture, or any combination thereof, or its authorized representative, named as such by the District. If no Program Manager is designated for Project that is the subject of this Contract, then all references to Project Manager herein shall be read to refer to District.

1.1.34 Project: The planned undertaking as provided for in the Contract Documents.

1.1.35 Project Inspector (or "Inspector"): The individual(s) retained by the District in accordance with title 24 of the California Code of Regulations to monitor and inspect the Project.

1.1.36 Project Labor Agreement (or "PLA"): a prehire collective bargaining agreement in accordance with Public Contract Code section 2500 et seq. that establishes terms and conditions of employment for a specific construction project or projects and/or is an agreement described in Section 158(f) of Title 29 of the United States Code.

1.1.37 Proposed Change Order (or "PCO"): a written request prepared by the Contractor requesting that the District and the Architect issue a Change Order based upon a proposed change to the Work.

1.1.38 Provide: Shall include "provide complete in place," that is, "furnish and install," and "provide complete and functioning as intended in place" unless specifically stated otherwise.

1.1.39 Qualified SWPPP Practitioners (or "QSP"): certified personnel that attended a State Water Resources Control Board sponsored or approved training class and passed the qualifying exam.

1.1.40 Record Drawings: Reproducible drawings (or Plans) prepared pursuant to the requirements of the Contract Documents that reflect all changes made during the performance of the Work, recording differences between the original design of the Work and the Work as constructed upon completion of the Project. See also **As-Builts**.

1.1.41 Request for Information (or "RFI"): A written request prepared by the Contractor requesting that the Architect provide additional information necessary to clarify or amplify an item in the Contract Documents that the Contractor believes is not clearly shown or called for in the Drawings or Specifications or other portions of the Contract Documents, or to address problems that have arisen under field conditions.

1.1.42 Request for Substitution for Specified Item: A request by Contractor to substitute an equal or superior material, product, thing, or service for a specific material, product, thing, or service that has been designated in the Contract Documents by a specific brand or trade name.

1.1.43 Safety Orders: Written and/or verbal orders for construction issued by the California Division of Occupational Safety and Health ("CalOSHA") or by the United States Occupational Safety and Health Administration ("OSHA").

1.1.44 Safety Plan: Contractor's safety plan specifically adapted for the Project. Contractor's Safety Plan shall comply with all provisions regarding Project safety, including all applicable provisions in these General Conditions.

1.1.45 Samples: Physical examples that illustrate materials, products, equipment, finishes, colors, or workmanship and that, when approved in accordance with the Contract Documents, establish standards by which portions of the Work will be judged.

1.1.46 Shop Drawings: All drawings, prints, diagrams, illustrations, brochures, schedules, and other data that are prepared by the Contractor, a subcontractor, manufacturer, supplier, or distributor, that illustrate how specific portions of the Work shall be fabricated or installed.

1.1.47 Site: The Project site as shown on the Drawings.

1.1.48 Specifications: That portion of the Contract Documents, Division 1 through Division 49, and all technical sections, and addenda to all of these, if any, consisting of written descriptions and requirements of a technical nature of materials, equipment, construction methods and systems, standards, and workmanship.

1.1.49 State: The State of California.

1.1.50 Storm Water Pollution Prevention Plan (or "SWPPP"): A document which identifies sources and activities at a particular facility that may contribute pollutants to storm water and contains specific control measures and time frames to prevent or treat such pollutants.

1.1.51 Subcontractor: A contractor and/or supplier who is under contract with the Contractor or with any other subcontractor, regardless of tier, to perform a portion of the Work of the Project.

1.1.52 Submittal Schedule: The schedule of submittals as provided by Contractor and approved by District.

1.1.53 Surety: The person, firm, or corporation that executes as surety the Contractor's Performance Bond and Payment Bond, and must be a California admitted surety insurer as defined in the Code of Civil Procedure section 995.120.

1.1.54 Work: All labor, materials, equipment, components, appliances, supervision, coordination, and services required by, or reasonably inferred from, the Contract Documents, that are necessary for the construction and completion of the Project.

1.2 Laws Concerning the Contract

Contract is subject to all provisions of the Constitution and laws of California and the United States governing, controlling, or affecting District, or the property, funds, operations, or powers of District, and such provisions are by this reference made a part hereof. Any provision required by law to be included in this Contract shall be deemed to be inserted.

1.3 No Oral Agreements

No oral agreement or conversation with any officer, agent, or employee of District, either before or after execution of Contract, shall affect or modify any of the terms or obligations contained in any of the documents comprising the Contract.

1.4 No Assignment

Contractor shall not assign this Contract or any part thereof including, without limitation, any Work or money to become due hereunder without the prior written consent of the District. Assignment without District's prior written consent shall be null and void. Any assignment of money due or to become due under this Contract shall be subject to a prior lien for services rendered or material supplied for performance of work called for under this Contract in favor of all persons, firms, or corporations rendering services or supplying material to the extent that claims are filed pursuant to the Civil Code, Code of Civil Procedure, Government Code, Labor Code, and/or Public Contract Code, and shall also be subject to deductions for liquidated damages or withholding of payments as determined by District in accordance with this Contract. Contractor shall not assign or transfer in any manner to a Subcontractor or supplier the right to prosecute or maintain an action against the District.

1.5 Notice and Service Thereof

1.5.1 Any notice from one party to the other or otherwise under Contract shall be in writing and shall be dated and signed by the party giving notice or by a duly authorized representative of that party. Any notice shall not be effective for any purpose whatsoever unless served in one of the following manners:

1.5.1.1 If notice is given by personal delivery thereof, it shall be considered delivered on the day of delivery.

1.5.1.2 If notice is given by overnight delivery service, it shall be considered delivered one (1) day after date deposited, as indicated by the delivery service.

1.5.1.3 If notice is given by depositing same in United States mail, enclosed in a sealed envelope, it shall be considered delivered three (3) days after date deposited, as indicated by the postmarked date.

1.5.1.4 If notice is given by registered or certified mail with postage prepaid, return receipt requested, it shall be considered delivered on the day the notice is signed for.

1.5.1.5 Electronic mail may be used for convenience but is not a substitute for the notice and service requirements herein.

1.6 No Waiver

The failure of District in any one or more instances to insist upon strict performance of any of the terms of this Contract or to exercise any option herein conferred shall not be construed as a waiver or relinquishment to any extent of the right to assert or rely upon any such terms or option on any future occasion. No action or failure to act by the District, Architect, or Construction Manager shall constitute a waiver of any right or duty afforded the District under the Contract, nor shall any action or failure to act constitute

an approval of or acquiescence in any breach thereunder, except as may be specifically agreed in writing.

1.7 Substitutions for Specified Items

1.7.1 Whenever in the Specifications any materials, process, or article is indicated or specified by grade, patent, or proprietary name, or by name of manufacturer, that Specification shall be deemed to be followed by the words "or equal." Contractor may, unless otherwise stated, offer any material, process, or article that shall be substantially equal or better in every respect to that so indicated or specified.

1.7.1.1 If the material, process, or article offered by Contractor is not, in the opinion of the District, substantially equal or better in every respect to that specified, then Contractor shall furnish the material, process, or article specified in the Specifications without any additional compensation or change order.

1.7.1.2 This provision shall not be applicable with respect to any material, product, thing or service for which District made findings and gave notice in accordance with Public Contract Code section 3400(c); therefore, Contractor shall not be entitled to request a substitution with respect to those materials, products or services.

1.7.2 A request for a substitution shall be submitted as follows:

1.7.2.1 Contractor shall notify the District in writing of any request for a substitution at least ten (10) days prior to bid opening as indicated in the Instructions to Bidders.

1.7.2.2 Requests for Substitutions after award of the Contract shall be submitted within thirty-five (35) days of the date of the Notice of Award.

1.7.3 Within 35 days after the date of the Notice of Award, Contractor shall provide data substantiating a request for substitution of "an equal" item, including but not limited to the following:

1.7.3.1 All variations of the proposed substitute from the material specified including, but not limited to, principles of operation, materials, or construction finish, thickness or gauge of materials, dimensions, weight, and tolerances;

1.7.3.2 Available maintenance, repair or replacement services;

1.7.3.3 Increases or decreases in operating, maintenance, repair, replacement, and spare parts costs;

1.7.3.4 Whether or not acceptance of the substitute will require other changes in the Work (or in work performed by the District or others under Contract with the District); and

1.7.3.5 The time impact on any part of the Work resulting directly or indirectly from acceptance of the proposed substitute.

1.7.4 No substitutions shall be made until approved, in writing, by the District. The burden of proof as to equality of any material, process, or article shall rest with Contractor. The Contractor warrants that if substitutes are approved:

1.7.4.1 The proposed substitute is equal or superior in all respects to that specified, and that such proposed substitute is suitable and fit for the intended purpose and will perform adequately the function and achieve the results called for by the general design and the Contract Documents;

1.7.4.2 The Contractor provides the same warranties and guarantees for the substitute that would be provided for that specified;

1.7.4.3 The Contractor shall be fully responsible for the installation of the substitute and any changes in the Work required, either directly or indirectly, because of the acceptance of such substitute, with no increase in Contract Price or Contract Time. Incidental changes or extra component parts required to accommodate the substitute will be made by the Contractor without a change in the Contract Price or Contract Time;

1.7.4.4 The Contractor shall be responsible for any re-design costs occasioned by District's acceptance and/or approval of any substitute; and

1.7.4.5 The Contractor shall, in the event that a substitute is less costly than that specified, credit the District with one hundred percent (100%) of the net difference between the substitute and the originally specified material. In this event, the Contractor agrees to execute a deductive Change Order to reflect that credit.

1.7.5 In the event Contractor furnishes a material, process, or article more expensive than that specified, the difference in the cost of that material, process, or article so furnished shall be borne by Contractor.

1.7.6 In no event shall the District be liable for any increase in Contract Price or Contract Time due to any claimed delay in the evaluation of any proposed substitute or in the acceptance or rejection of any proposed substitute.

1.7.7 Contractor shall be responsible for any costs the District incurs for professional services, DSA fees, or delay to the Project Schedule, if applicable, while DSA reviews changes for the convenience of Contractor and/or to accommodate Contractor's means and methods. District may deduct those costs from any amounts owing to the Contractor for the review of the request for substitution, even if the request for substitution is not approved. District, at its sole discretion, shall deduct from the payments due to and/or invoice Contractor for all the professional services and/or DSA fees or delay to the Project Schedule, if applicable, while DSA reviews changes for the convenience of Contractor and/or to accommodate Contractor's means and methods arising herein..

1.8 Materials and Work

1.8.1 Except as otherwise specifically stated in this Contract, Contractor shall provide and pay for all materials, labor, tools, equipment, transportation, supervision, temporary constructions of every nature, and all other services, management, and facilities of every nature whatsoever necessary to execute and complete this Contract, in a good and workmanlike manner, within the Contract Time.

1.8.2 Unless otherwise specified, all materials shall be new and of the best quality of their respective kinds and grades as noted or specified, workmanship shall

be of good quality, and Contractor shall use all diligence to inform itself fully as to the required manufacturer's instructions and to comply therewith.

1.8.3 Materials shall be furnished in ample quantities and at such times as to insure uninterrupted progress of Work and shall be stored properly and protected from the elements, theft, vandalism, or other loss or damage as required.

1.8.4 For all materials and equipment specified or indicated in the Drawings, the Contractor shall provide all labor, materials, equipment, and services necessary for complete assemblies and complete working systems, functioning as intended. Incidental items not indicated on Drawings, nor mentioned in the Specifications, that can legitimately and reasonably be inferred to belong to the Work described or be necessary in good practice to provide a complete assembly or system, shall be furnished as though itemized here in every detail. In all instances, material and equipment shall be installed in strict accordance with each manufacturer's most recent published recommendations and specifications.

1.8.5 Contractor shall, after award of Contract by District and after relevant submittals have been reviewed, place orders for materials and/or equipment as specified so that delivery of same may be made without delays to the Work. Contractor shall, upon five (5) days' demand from District, present documentary evidence showing that orders have been placed.

1.8.6 District reserves the right but has no obligation, in response to Contractor's neglect or failure in complying with the above instructions, to place orders for such materials and/or equipment as the District may deem advisable in order that the Work may be completed at the date specified in the Contract, and all expenses incidental to the procuring of said materials and/or equipment shall be paid for by Contractor or deducted from payment(s) to Contractor.

1.8.7 Contractor warrants good title to all material, supplies, and equipment installed or incorporated in Work and agrees upon completion of all Work to deliver the Site to District, together with all improvements and appurtenances constructed or placed thereon by it, and free from any claims, liens, or charges. Contractor further agrees that neither it nor any person, firm, or corporation furnishing any materials or labor for any work covered by the Contract shall have any right to lien any portion of the Premises or any improvement or appurtenance thereon, except that Contractor may install metering devices or other equipment of utility companies or of political subdivision, title to which is commonly retained by utility company or political subdivision. In the event of installation of any such metering device or equipment, Contractor shall advise District as to owner thereof.

1.8.7.1 If a lien or a claim based on a stop payment notice of any nature should at any time be filed against the Work or any District property, by any entity that has supplied material or services at the request of the Contractor, Contractor and Contractor's Surety shall promptly, on demand by District and at Contractor's and Surety's own expense, take any and all action necessary to cause any such lien or a claim based on a stop payment notice to be released or discharged immediately therefrom.

1.8.7.2 If the Contractor fails to furnish to the District within ten (10) calendar days after demand by the District, satisfactory evidence that a lien or a claim

based on a stop payment notice has been so released, discharged, or secured, the District may discharge such indebtedness and deduct the amount required therefor, together with any and all losses, costs, damages, and attorney's fees and expense incurred or suffered by District from any sum payable to Contractor under the Contract.

1.8.8 Nothing contained in this Article, however, shall defeat or impair the rights of persons furnishing materials or labor under any bond given by Contractor for their protection or any rights under any law permitting such protection or any rights under any law permitting such persons to look to funds due Contractor in hands of District (e.g., stop payment notices), and this provision shall be inserted in all subcontracts and material contracts and notice of its provisions shall be given to all persons furnishing material for work when no formal contract is entered into for such material.

1.8.9 Title to new materials and/or equipment for the Work of this Contract and attendant liability for its protection and safety shall remain with Contractor until incorporated in the Work of this Contract and accepted by District. No part of any materials and/or equipment shall be removed from its place of storage except for immediate installation in the Work of this Contract. Should the District, in its discretion, allow the Contractor to store materials and/or equipment for the Work off-site, Contractor will store said materials and/or equipment at a bonded warehouse and with appropriate insurance coverage at no cost to District. Contractor shall keep an accurate inventory of all materials and/or equipment in a manner satisfactory to District or its authorized representative and shall, at the District's request, forward it to the District.

1.8.10 [RESERVED]

2. [RESERVED]

3. ARCHITECT

3.1 The Architect shall represent the District during the Project and will observe the progress and quality of the Work on behalf of the District. Architect shall have the authority to act on behalf of District to the extent expressly provided in the Contract Documents and to the extent determined by District. Architect shall have authority to reject materials, workmanship, and/or the Work whenever rejection may be necessary, in Architect's reasonable opinion, to ensure the proper execution of the Contract.

3.2 Architect shall, with the District and on behalf of the District, determine the amount, quality, acceptability, and fitness of all parts of the Work, and interpret the Specifications, Drawings, and shall, with the District, interpret all other Contract Documents.

3.3 Architect shall have all authority and responsibility established by law, including title 24 of the California Code of Regulations.

3.4 Contractor shall provide District and the Construction Manager with a copy of all written communication between Contractor and Architect at the same time as that communication is made to Architect, including, without limitation, all RFIs, correspondence, submittals, claims, and proposed change orders.

4. CONSTRUCTION MANAGER

4.1 If a Construction Manager is used on this Project ("Construction Manager" or "CM"), the Construction Manager will provide administration of the Contract on the District's behalf. After execution of the Contract and Notice to Proceed, all correspondence and/or instructions from Contractor and/or District shall be forwarded through the Construction Manager. The Construction Manager will not be responsible for and will not have control or charge of construction means, methods, techniques, sequences, or procedures or for safety precautions in connection with the Work, which shall all remain the Contractor's responsibility.

4.2 The Construction Manager, however, will have authority to reject materials and/or workmanship not conforming to the Contract Documents, as determined by the District, the Architect, and/or the Project Inspector. The Construction Manager shall also have the authority to require special inspection or testing of any portion of the Work, whether it has been fabricated, installed, or fully completed. Any decision made by the Construction Manager, in good faith, shall not give rise to any duty or responsibility of the Construction Manager to: the Contractor; any Subcontractor; the Contractor or Subcontractor's respective agents, employees; or other persons performing any of the Work. The Construction Manager shall have free access to any or all parts of Work at any time.

4.3 If the District does not use a Construction Manager on this Project, all references within the Contract Documents to Construction Manager or CM shall be read as District.

5. INSPECTOR, INSPECTIONS, AND TESTS

5.1 Project Inspector

5.1.1 One or more Project Inspector(s), including special Project Inspector(s), as required, will be assigned to the Work by District, in accordance with requirements of title 24, part 1, of the California Code of Regulations, to enforce the building code and monitor compliance with Plans and Specifications for the Project previously approved by the DSA. Duties of Project Inspector(s) are specifically defined in section 4-342 of said part 1 of title 24.

5.1.2 No Work shall be carried on except with the knowledge and under the inspection of the Project Inspector(s). The Project Inspector(s) shall have free access to any or all parts of Work at any time. Contractor shall furnish Project Inspector(s) reasonable opportunities for obtaining such information as may be necessary to keep Project Inspector(s) fully informed respecting progress and manner of work and character of materials, including, but not limited to, submission of form DSA 156 (or the most current version applicable at the time the Work is performed) to the Project Inspector at least 48 hours in advance of the commencement and completion of construction of each and every aspect of the Work. Forms are available on the DSA's website at: <http://www.dgs.ca.gov/dsa/Forms.aspx>. Inspection of Work shall not relieve Contractor from an obligation to fulfill this Contract. Project Inspector(s) and the DSA are authorized to suspend work whenever the Contractor and/or its Subcontractor(s) are not complying with the Contract Documents. Any work

stoppage by the Project Inspector(s) and/or DSA shall be without liability to the District. Contractor shall instruct its Subcontractors and employees accordingly.

5.1.3 If Contractor and/or any Subcontractor requests that the Project Inspector(s) perform any inspection off-site, this shall only be done if it is allowable pursuant to applicable regulations and DSA approval, if the Project Inspector(s) agree to do so, and at the expense of the Contractor.

5.2 Tests and Inspections

5.2.1 Tests and Inspections shall comply with title 24, part 1, California Code of Regulations, group 1, article 5, section 4-335, and with the provisions of the Specifications.

5.2.2 The District will select an independent testing laboratory to conduct the tests. Selection of the materials required to be tested shall be by the laboratory or the District's representative and not by the Contractor. The Contractor shall notify the District's representative a sufficient time in advance of its readiness for required observation or inspection.

5.2.3 The Contractor shall notify the District's representative a sufficient time in advance of the manufacture of material to be supplied under the Contract Documents, which must by terms of the Contract Documents be tested, in order that the District may arrange for the testing of same at the source of supply. This notice shall be provided, at a minimum, seventy-two (72) hours prior to the manufacture of the material that needs to be tested.

5.2.4 Any material shipped by the Contractor from the source of supply prior to having satisfactorily passed such testing and inspection or prior to the receipt of notice from said representative that such testing and inspection will not be required, shall not be incorporated into and/or onto the Project.

5.2.5 The District will select the testing laboratory and pay for the cost of all tests and inspections, excepting those inspections performed at Contractor's request and expense. Contractor shall reimburse the District for any and all laboratory costs or other testing costs for any materials found to be not in compliance with the Contract Documents. At the District's discretion, District may elect to deduct laboratory or other testing costs for noncompliant materials from the Contract Price, and such deduction shall not constitute a withholding.

5.3 Costs for After Hours and/or Off Site Inspections

If the Contractor performs Work outside the Inspector's regular working hours or requests the Inspector to perform inspections off Site, costs of any inspections required outside regular working hours or off Site shall be borne by the Contractor and may be invoiced to the Contractor by the District or the District may deduct those expenses from the next Progress Payment.

6. CONTRACTOR

Contractor shall construct and complete, in a good and workmanlike manner, the Work for the Contract Price including any adjustment(s) to the Contract Price pursuant to provisions

herein regarding changes to the Contract Price. Except as otherwise noted, Contractor shall provide and pay for all labor, materials, equipment, permits (excluding DSA), fees, licenses, facilities, transportation, taxes, bonds and insurance, and services necessary for the proper execution and completion of the Work, except as indicated herein.

6.1 Status of Contractor

6.1.1 Contractor is and shall at all times be deemed to be an independent contractor and shall be wholly responsible for the manner in which it and its Subcontractors perform the services required of it by the Contract Documents. Nothing herein contained shall be construed as creating the relationship of employer and employee, or principal and agent, between the District, or any of the District's employees or agents, and Contractor or any of Contractor's Subcontractors, agents or employees. Contractor assumes exclusively the responsibility for the acts of its agents, and employees as they relate to the services to be provided during the course and scope of their employment. Contractor, its Subcontractors, agents, and its employees shall not be entitled to any rights or privileges of District employees. District shall be permitted to monitor the Contractor's activities to determine compliance with the terms of this Contract.

6.1.2 As required by law, Contractor and all Subcontractors shall be properly licensed and regulated by the Contractors State License Board, 9821 Business Park Drive, Sacramento, California 95827, <http://www.cslb.ca.gov>.

6.1.3 As required by law, Contractor and all Subcontractors shall be properly registered as public works contractors by the Department of Industrial Relations at: <https://efiling.dir.ca.gov/PWCR/ActionServlet?action=displayPWCRRegistrationForm> or current URL.

6.1.4 Contractor represents that Contractor and all Subcontractors shall not be presently debarred, suspended, proposed for disbarment, declared ineligible or excluded pursuant to either Labor Code section 1777.1 or Labor Code section 1777.7.

6.1.5 [RESERVED]

6.1.6 Contractor represents that it has no existing interest and will not acquire any interest, direct or indirect, which could conflict in any manner or degree with the performance of Work required under this Contract and that no person having any such interest shall be employed by Contractor.

6.1.7 [RESERVED]

6.1.8 If Contractor intends to make any change in the name or legal nature of the Contractor's entity, Contractor must first notify the District in writing prior to making any contemplated change. The District shall determine in writing if Contractor's intended change is permissible while performing this Contract.

[THE REMAINDER OF THIS PAGE LEFT BLANK INTENTIONALLY]

6.2 Project Inspection Card(s)

Contractor shall verify that forms DSA 152 (or the current version applicable at the time the Work is performed) are issued for the Project prior to the commencement of construction.

6.3 Contractor's Supervision

6.3.1 During progress of the Work, Contractor shall keep on the Premises, and at all other locations where any Work related to the Contract is being performed, an experienced and competent project manager and a full-time construction superintendent who are employees of the Contractor, to whom the District does not object and at least one of whom shall be fluent in English, written and verbal.

6.3.2 The project manager and construction superintendent shall both speak fluently the predominant language of the Contractor's employees.

6.3.3 Before commencing the Work herein, Contractor shall give written notice to District of the name of its project manager and construction superintendent. Neither the Contractor's project manager nor construction superintendent shall be changed except with prior written notice to District. If the Contractor's project manager and/or construction superintendent proves to be unsatisfactory to Contractor, or to District, any of the District's employees, agents, the Construction Manager, or the Architect, the unsatisfactory project manager and/or construction superintendent shall be replaced. However, Contractor shall notify District in writing before any change occurs, but no less than two (2) business days prior. Any replacement of the project manager and/or construction superintendent shall be made promptly and must be satisfactory to the District. The Contractor's project manager and construction superintendent shall each represent Contractor, and all directions given to Contractor's project manager and/or construction superintendent shall be as binding as if given to Contractor.

6.3.4 Contractor shall give efficient supervision to Work, using its best skill and attention. Contractor shall carefully study and compare all Contract Documents, Drawings, Specifications, and other instructions and shall at once report to District, Construction Manager, and Architect any error, inconsistency, or omission that Contractor or its employees and Subcontractors may discover, in writing, with a copy to District's Project Inspector(s). The Contractor shall have responsibility for discovery of errors, inconsistencies, or omissions.

6.4 Duty to Provide Fit Workers

6.4.1 Contractor and Subcontractor(s) shall at all times enforce strict discipline and good order among their employees and shall not employ or work any unfit person or anyone not skilled in work assigned to that person. It shall be the responsibility of Contractor to ensure compliance with this requirement. District may require Contractor to permanently remove unfit persons from Project Site.

6.4.2 Any person in the employ of Contractor or Subcontractor(s) whom District may deem incompetent or unfit shall be excluded from working on the Project and shall not again be employed on the Project except with the prior written consent of District.

6.4.3 The Contractor shall furnish labor that can work in harmony with all other elements of labor employed or to be employed in the Work.

6.4.4 Fingerprinting

Contractor shall comply with the provisions of Education Code section 45125.2 regarding the submission of employee fingerprints to the California Department of Justice and the completion of criminal background investigations of its employees, its subcontractor(s), and its subcontractors' employees. Contractor shall not permit any employee to have any contact with District pupils until such time as Contractor has verified in writing to the governing board of the District, (A) that such employee has not been convicted of a violent or serious felony, as defined in Education Code section 45122.1 and/or (B) that the prohibition does not apply to an employee as provided by Education Code section 45125.1(e)(2) or (3). Contractor shall fully complete and perform all tasks required pursuant to the Criminal Background Investigation/ Fingerprinting Certification.

6.5 Field Office

6.5.1 Contractor shall provide a temporary office on the Site for the District's use exclusively, during the term of the Contract.

6.6 Purchase of Materials and Equipment

The Contractor is required to order, obtain, and store materials and equipment sufficiently in advance of its Work at no additional cost or advance payment from District to assure that there will be no delays.

6.7 Documents on Work

6.7.1 Contractor shall at all times keep on the Site, or at another location as the District may authorize in writing, one legible copy of all Contract Documents, including Addenda and Change Orders, and Titles 19 and 24 of the California Code of Regulations, the specified edition(s) of the Uniform Building Code, all approved Drawings, Plans, Schedules, and Specifications, and all codes and documents referred to in the Specifications, and made part thereof. These documents shall be kept in good order and available to District, Construction Manager, Architect, Architect's representatives, the Project Inspector(s), and all authorities having jurisdiction. Contractor shall be acquainted with and comply with the provisions of these titles as they relate to this Project. (See particularly the duties of Contractor, Title 24, Part 1, California Code of Regulations, section 4-343.) Contractor shall also be acquainted with and comply with all California Code of Regulations provisions relating to conditions on this Project, particularly Titles 8 and 17. Contractor shall coordinate with Architect and Construction Manager and shall submit its verified report(s) according to the requirements of Title 24.

6.7.2 Daily Job Reports.

6.7.2.1 Contractor shall maintain, at a minimum, at least one (1) set of Daily Job Reports on the Project. These must be prepared by the Contractor's employee(s) who are present on Site, and must include, at a minimum, the following information:

- 6.7.2.1.1** A brief description of all Work performed on that day.
- 6.7.2.1.2** A summary of all other pertinent events and/or occurrences on that day.
- 6.7.2.1.3** The weather conditions on that day.
- 6.7.2.1.4** A list of all Subcontractor(s) working on that day, including DIR registration numbers.
- 6.7.2.1.5** A list of each Contractor employee working on that day and the total hours worked for each employee.
- 6.7.2.1.6** A complete list of all equipment on Site that day, whether in use or not.
- 6.7.2.1.7** A complete list of all materials, supplies, and equipment delivered on that day.
- 6.7.2.1.8** A complete list of all inspections and tests performed on that day.

6.7.2.2 Each day Contractor shall provide a copy of the previous day's Daily Job Report to the District or the Construction Manager.

6.8 Preservation of Records

Contractor shall maintain, and District shall have the right to inspect, Contractor's financial records for the Project, including, without limitation, Job Cost Reports for the Project in compliance with the criteria set forth herein. The District shall have the right to examine and audit all Daily Job Reports or other Project records of Contractor's project manager(s), project superintendent(s), and/or project foreperson(s), all certified payroll records and/or related documents including, without limitation, Job Cost Reports, payroll, payment, timekeeping and tracking documents; all books, estimates, records, contracts, documents, bid documents, bid cost data, subcontract job cost reports, and other data of the Contractor, any Subcontractor, and/or supplier, including computations and projections related to bidding, negotiating, pricing, or performing the Work or Contract modification, in order to evaluate the accuracy, completeness, and currency of the cost, manpower, coordination, supervision, or pricing data at no additional cost to the District. These documents may be duplicative and/or be in addition to any Bid Documents held in escrow by the District. The Contractor shall make available at its office at all reasonable times the materials described in this paragraph for the examination, audit, or reproduction until three (3) years after final payment under this Contract. Notwithstanding the provisions above, Contractor shall provide any records requested by any governmental agency, if available, after the time set forth above.

6.9 Integration of Work

6.9.1 Contractor shall do all cutting, fitting, patching, and preparation of Work as required to make its several parts come together properly, to fit it to receive or be received by work of other contractors, and to coordinate tolerances to various pieces of work, showing upon, or reasonably implied by, the Drawings and Specifications for the completed structure, and shall conform them as District and/or Architect may direct.

6.9.2 Contractor shall make its own layout of lines and elevations and shall be responsible for the accuracy of both Contractor's and Subcontractors' work resulting therefrom.

6.9.3 Contractor and all Subcontractors shall take all field dimensions required in performance of the Work, and shall verify all dimensions and conditions on the Site. All dimensions affecting proper fabrication and installation of all Work must be verified prior to fabrication by taking field measurements of the true conditions. If there are any discrepancies between dimensions in drawings and existing conditions which will affect the Work, Contractor shall bring such discrepancies to the attention of the District and Architect for adjustment before proceeding with the Work. In doing so, it is recognized that Contractor is not acting in the capacity of a licensed design professional, and that Contractor's examination is made in good faith to facilitate construction and does not create an affirmative responsibility of a design professional to detect errors, omissions or inconsistencies in the Contract Documents or to ascertain compliance with applicable laws, building codes or regulations. However, nothing in this provision shall abrogate Contractor's responsibilities for discovering and reporting any error, inconsistency, or omission pursuant to the Contract within the Contractor's standard of care including, without limitation, any applicable laws, ordinance, rules, or regulations. Following receipt of written notice from Contractor, the District and/or Architect shall inform Contractor what action, if any, Contractor shall take with regard to such discrepancies.

6.9.4 All costs caused by noncompliant, defective, or delayed Work shall be borne by Contractor, inclusive of repair work. Schedule delays resulting from unauthorized work shall be Contractor's responsibility.

6.9.5 Contractor shall not endanger any work performed by it or anyone else by cutting, excavating, or otherwise altering work and shall not cut or alter work of any other contractor except with consent of District.

6.10 Notifications

6.10.1 Contractor shall notify the Architect and Project Inspector, in writing, of the commencement of construction of each and every aspect of the Work at least 48 hours in advance by submitting form DSA 156 (or the most current version applicable at the time the Work is performed) to the Project Inspector. Forms are available on the DSA's website at: <http://www.dgs.ca.gov/dsa/Forms.aspx>.

6.10.2 Contractor shall notify the Architect and Project Inspector, in writing, of the completion of construction of each and every aspect of the Work at least 48 hours in advance by submitting form DSA 156 (or current version) to the Project Inspector.

6.11 Obtaining of Permits, Licenses and Registrations

6.11.1 Contractor shall secure and pay for all permits (except DSA), licenses, registrations, approvals and certificates necessary for prosecution of Work, including but not limited to those listed in the Special Conditions, if any, before the date of the commencement of the Work or before the permits, licenses, registrations, approvals and certificates are legally required to continue the Work without interruption. The Contractor shall obtain and pay, only when legally required, for all licenses, registrations, approvals, permits, inspections, and inspection certificates required to be obtained from or issued by any authority having jurisdiction over any part of the Work included in the Contract. All final permits, licenses, registrations, approvals

and certificates shall be delivered to District before demand is made for final payment.

6.11.2 General Permit For Storm Water Discharges Associated With Construction and Land Disturbance Activities.

6.11.2.1 Contractor acknowledges that all California school districts are obligated to develop and implement the following requirements for the discharge of storm water to surface waters from its construction and land disturbance activities pursuant to the Clean Water Act and Porter Cologne Water Quality Act. District has determined that the construction of this Project requires enrollment in the Construction Storm Water Permit. District has filed certain submittals referred to as Permit Registration Documents ("PRDS") with the Regional Water Control Board ("Storm Water Pollution Prevention Plan" or "SWPPP").

6.11.2.2 Contractor shall comply with any District SWPPP that is approved by the District and applicable to the Project, at no additional cost to the District. Contractor shall pay any fees and any penalties that may imposed by a regulatory agency for its non-compliance with the SWPPP during the course of Work.

6.11.2.3 Contractor shall provide a Qualified Storm Water Practitioner ("QSP") at no additional cost to the District, who shall be onsite and implement and monitor any and all SWPPP requirements applicable to the Project, including but not limited to:

6.11.2.3.1 All required visual observations, sampling, analysis, reporting and record keeping, including any Numeric Action Levels ("NALs"), if applicable;

6.11.2.3.2 Rain Event Action Plan ("REAP") at least forty eight (48) hours prior to any forecasted rain event requiring implementation of the REAP, including any erosion and sediment control measures needed to protect all exposed portions of the site, if applicable;

6.11.2.3.3 Active Treatment System ("ATS"), if applicable; and

6.11.2.3.4 Best management practices ("BMPs").

6.12 Royalties and Patents

6.12.1 Contractor shall obtain and pay, only when legally required, all royalties and license fees necessary for prosecution of Work before the earlier of the date of the commencement of the Work or the date that the license is legally required to continue the Work without interruption. Contractor shall defend suits or claims of infringement of patent, copyright, or other rights and shall hold the District, the Architect, and the Construction Manager harmless and indemnify them from loss on account thereof except when a particular design, process, or make or model of product is required by the Contract Documents. However, if the Contractor has reason to believe that the required design, process, or product is an infringement of a patent or copyright, the Contractor shall indemnify and defend the District,

Architect and Construction Manager against any loss or damage unless the Contractor promptly informs the District of its information.

6.12.2 The review by the District or Architect of any method of construction, invention, appliance, process, article, device, or material of any kind shall be only its adequacy for the Work and shall not approve use by the Contractor in violation of any patent or other rights of any person or entity.

6.13 Work to Comply with Applicable Laws and Regulations

6.13.1 Contractor shall give all notices and comply with the following specific laws, ordinances, rules, and regulations and all other applicable laws, ordinances, rules, and regulations bearing on conduct of Work as indicated and specified, including but not limited to the appropriate statutes and administrative code sections. If Contractor observes that Drawings and Specifications are at variance therewith, or should Contractor become aware of the development of conditions not covered by Contract Documents that may result in finished Work being at variance therewith, Contractor shall promptly notify District in writing and any changes deemed necessary by District shall be made as provided in Contract for changes in Work.

6.13.1.1 National Electrical Safety Code, U. S. Department of Commerce

6.13.1.2 National Board of Fire Underwriters' Regulations

6.13.1.3 International Building Code, latest addition, and the California Code of Regulations, title 24, and other amendments

6.13.1.4 Manual of Accident Prevention in Construction, latest edition, published by A.G.C. of America

6.13.1.5 Industrial Accident Commission's Safety Orders, State of California

6.13.1.6 Regulations of the State Fire Marshall (title 19, California Code of Regulations) and Pertinent Local Fire Safety Codes

6.13.1.7 Americans with Disabilities Act

6.13.1.8 Education Code of the State of California

6.13.1.9 Government Code of the State of California

6.13.1.10 Labor Code of the State of California, division 2, part 7, Public Works and Public Agencies

6.13.1.11 Public Contract Code of the State of California

6.13.1.12 California Art Preservation Act

6.13.1.13 U. S. Copyright Act

6.13.1.14 U. S. Visual Artists Rights Act

6.13.2 Contractor shall comply with all applicable mitigation measures, if any, adopted by any public agency with respect to this Project pursuant to the California Environmental Quality Act (Public Resources Code section 21000 et seq.).

6.13.3 If Contractor performs any Work that it knew, or through exercise of reasonable care should have known, to be contrary to any applicable laws, ordinance, rules, or regulations, Contractor shall bear all costs arising therefrom and arising from the correction of said Work.

6.13.4 Where Specifications or Drawings state that materials, processes, or procedures must be approved by the DSA, State Fire Marshall, or other body or agency, Contractor shall be responsible for satisfying requirements of such bodies or agencies applicable at the time the Work is performed, and as determined by those bodies or agencies.

6.13.5 [RESERVED]

6.14 Safety/Protection of Persons and Property

6.14.1 The Contractor will be solely and completely responsible for conditions of the Site, including safety of all persons and property during performance of the Work. This requirement will apply continuously and not be limited to normal working hours.

6.14.2 The wearing of hard hats will be mandatory at all times for all personnel on Site. Contractor shall supply sufficient hard hats to properly equip all employees and visitors.

6.14.3 Any construction review of the Contractor's performance is not intended to include review of the adequacy of the Contractor's safety measures in, on, or near the Site.

6.14.4 Implementation and maintenance of safety programs shall be the sole responsibility of the Contractor.

6.14.5 The Contractor shall furnish to the District a copy of the Contractor's safety plan within the time frame indicated in the Contract Documents and specifically adapted for the Project.

6.14.6 Contractor shall be responsible for all damages to persons or property that occur as a result of its fault or negligence in connection with the prosecution of this Contract and shall take all necessary measures and be responsible for the proper care and completion and final acceptance by District. All Work shall be solely at Contractor's risk with the exception of damage to the Work caused by "acts of God" as defined in Public Contract Code section 7105.

6.14.7 Contractor shall take, and require Subcontractors to take, all necessary precautions for safety of workers on the Project and shall comply with all applicable federal, state, local, and other safety laws, standards, orders, rules, regulations, and building codes to prevent accidents or injury to persons on, about, or adjacent to premises where Work is being performed and to provide a safe and healthful place of employment. Contractor shall furnish, erect, and properly maintain at all times, all

necessary safety devices, safeguards, construction canopies, signs, nets, barriers, lights, and watchmen for protection of workers and the public and shall post danger signs warning against hazards created by such features in the course of construction.

6.14.8 Hazards Control – Contractor shall store volatile wastes in covered metal containers and remove them from the Site daily. Contractor shall prevent accumulation of wastes that create hazardous conditions. Contractor shall provide adequate ventilation during use of volatile or noxious substances.

6.14.9 Contractor shall designate a responsible member of its organization on the Project, whose duty shall be to post information regarding protection and obligations of workers and other notices required under occupational safety and health laws, to comply with reporting and other occupational safety requirements, and to protect the life, safety, and health of workers. Name and position of person so designated shall be reported to District by Contractor.

6.14.10 Contractor shall correct any violations of safety laws, rules, orders, standards, or regulations. Upon the issuance of a citation or notice of violation by the Division of Occupational Safety and Health, Contractor shall correct such violation promptly.

6.14.11 Contractor shall comply with any District storm water requirements that are approved by the District and applicable to the Project, at no additional cost to the District.

6.14.12 In an emergency affecting safety of life or of work or of adjoining property, Contractor, without special instruction or authorization, shall act, at its discretion, to prevent such threatened loss or injury. Any compensation claimed by Contractor on account of emergency work shall be determined by agreement.

6.14.13 All salvage materials will become the property of the Contractor and shall be removed from the Site unless otherwise called for in the Contract Documents. However, the District reserves the right to designate certain items of value that shall be turned over to the District unless otherwise directed by District.

6.14.14 All connections to public utilities and/or existing on-site services, including, without limitation, internet, phone and data connections, shall be made and maintained in such a manner as to not interfere with the continuing use of same by the District during the entire progress of the Work.

6.14.15 Contractor shall provide such heat, covering, and enclosures as are necessary to protect all Work, materials, equipment, appliances, and tools against damage by weather conditions, such as extreme heat, cold, rain, snow, dry winds, flooding, or dampness.

6.14.16 The Contractor shall protect and preserve the Work from all damage or accident, providing any temporary roofs, window and door coverings, boxings, or other construction as required by the Architect. The Contractor shall be responsible for existing structures, walks, roads, trees, landscaping, and/or improvements in working areas; and shall provide adequate protection therefore. If temporary removal is necessary of any of the above items, or damage occurs due to the Work, the Contractor shall replace same at his expense with same kind, quality, and size of

Work or item damaged. This shall include any adjoining property of the District and others.

6.14.17 Contractor shall take adequate precautions to protect existing roads, sidewalks, curbs, pavements, utilities, adjoining property, and structures (including, without limitation, protection from settlement or loss of lateral support), and to avoid damage thereto, and repair any damage thereto caused by construction operations.

6.14.18 Contractor shall confine apparatus, the storage of materials, and the operations of workers to limits indicated by law, ordinances, permits, or directions of Architect, and shall not interfere with the Work or unreasonably encumber Premises or overload any structure with materials. Contractor shall enforce all instructions of District and Architect regarding signs, advertising, fires, and smoking, and require that all workers comply with all regulations while on Project Site.

6.14.19 Contractor, Contractor's employees, Subcontractors, Subcontractors' employees, or any person associated with the Work shall conduct themselves in a manner appropriate for a school site. No verbal or physical contact with neighbors, students, and faculty, profanity, or inappropriate attire and/or logos, or behavior will be permitted. District may require Contractor to temporarily or permanently remove non-complying persons from Project Site.

6.14.20 Contractor shall take care to prevent disturbing or covering any survey markers, monuments, or other devices marking property boundaries or corners. If such markers are disturbed, Contractor shall have a civil engineer, registered as a professional engineer in California, replace them at no cost to District.

6.14.21 In the event that the Contractor enters into any agreement with owners of any adjacent property to enter upon the adjacent property for the purpose of performing the Work, Contractor shall fully indemnify, defend, and hold harmless each person, entity, firm, or agency that owns or has any interest in adjacent property. The form and content of the agreement of indemnification shall be approved by the District prior to the commencement of any Work on or about the adjacent property. The Contractor shall also indemnify the District as provided in the indemnification provision herein. These provisions shall be in addition to any other requirements of the owners of the adjacent property.

6.15 Working Evenings and Weekends

Contractor may be required to work increased hours, evenings, and/or weekends at no additional cost to the District. Contractor shall give the District seventy-two (72) hours' notice prior to performing any evening and/or weekend work. Contractor shall perform all evening and/or weekend work only upon District's approval and in compliance with all applicable rules, regulations, laws, and local ordinances including, without limitation, all noise and light limitations. Contractor shall reimburse the District for any increased or additional Inspector charges as a result of Contractor's increased hours, or evening and/or weekend work.

6.16 Cleaning Up

6.16.1 The Contractor shall provide all services, labor, materials, and equipment necessary for protecting and securing the Work, all school occupants, furnishings,

equipment, and building structure from damage until its completion and final acceptance by District. Dust barriers shall be provided to isolate dust and dirt from construction operations. At completion of the Work and portions thereof, Contractor shall clean to the original state any areas beyond the Work area that become dust laden as a result of the Work. The Contractor must erect the necessary warning signs and barricades to ensure the safety of all school occupants. The Contractor at all times must maintain good housekeeping practices to reduce the risk of fire damage and must make a fire extinguisher, fire blanket, and/or fire watch, as applicable, available at each location where cutting, braising, soldering, and/or welding is being performed or where there is an increased risk of fire.

6.16.2 Contractor at all times shall keep Premises, including property immediately adjacent thereto, free from debris such as waste, rubbish (including personal rubbish of workers, e.g., food wrappers, etc.), and excess materials and equipment caused by the Work. Contractor shall not leave debris under, in, or about the Premises (or surrounding property or neighborhood), but shall promptly remove same from the Premises on a daily basis. If Contractor fails to clean up, District may do so and the cost thereof shall be charged to Contractor. If Contract is for work on an existing facility, Contractor shall also perform specific clean-up on or about the Premises upon request by the District as it deems necessary for continued operations. Contractor shall comply with all related provisions of the Specifications.

6.16.3 If the Construction Manager, Architect, or District observes the accumulation of trash and debris, the District will give the Contractor a 24-hour written notice to mitigate the condition.

6.16.4 Should the Contractor fail to perform the required clean-up, or should the clean-up be deemed unsatisfactory by the District, the District may, at its sole discretion, then perform the clean-up. All cost associated with the clean-up work (including all travel, payroll burden, and costs for supervision) will be deducted from the Contract Price.

6.17 No Relief from Obligations Based on Review by Other Persons

6.17.1 Contractor shall not be relieved of obligations to perform the Work in accordance with the Contract Documents by act or omission of the District, Architect, Construction Manager, Project Inspector, or DSA or other entities having jurisdiction including, but not limited to, administration of the Contract, review of submittals, or by tests, observation, inspection, or permit/interconnection approvals.

7. SUBCONTRACTORS

7.1 Contractor shall provide the District with information for all Subcontracts as indicated in the Contractor's Submittals and Schedules Section herein.

7.2 No contractual relationship exists between the District and any Subcontractor, supplier, or sub-subcontractor by reason of this Contract.

7.3 Contractor agrees to bind every Subcontractor by terms of this Contract as far as those terms that are applicable to Subcontractor's work including, without limitation, all labor, wage & hour, apprentice and related provisions and requirements. If Contractor shall subcontract any part of this Contract, Contractor shall be as fully

responsible to District for acts and omissions of any Subcontractor and of persons either directly or indirectly employed by any Subcontractor, including Subcontractor caused Project delays, as it is for acts and omissions of persons directly employed by Contractor. The divisions or sections of the Specifications and/or the arrangement of the drawings are not intended to control the Contractor in dividing the Work among Subcontractors or limit the work performed by any trade.

7.4 District's consent to, or approval of, or failure to object to, any Subcontractor under this Contract shall not in any way relieve Contractor of any obligations under this Contract and no such consent shall be deemed to waive any provisions of this Contract.

7.5 Contractor is directed to familiarize itself with sections 4100 through 4114 of the Public Contract Code of the State of California, as regards subletting and subcontracting, and to comply with all applicable requirements therein. In addition, Contractor is directed to familiarize itself with sections 1720 through 1861 of the Labor Code of the State of California, as regards the payment of prevailing wages and related issues, and to comply with all applicable requirements therein including, without limitation, section 1775 and the Contractor's and Subcontractors' obligations and liability for violations of prevailing wage law and other applicable laws.

7.6 No Contractor whose Bid is accepted shall, without consent of the awarding authority and in full compliance with section 4100 et seq. of the Public Contract Code, including, without limitation, sections 4107, 4107.5, and 4109 of the Public Contract Code, and section 1771.1 of the Labor Code, either:

7.6.1 Substitute any person as a Subcontractor in place of the Subcontractor designated in the original Bid; or

7.6.2 Permit any Subcontract to be assigned or transferred, or allow any portion of the Work to be performed by anyone other than the original Subcontractor listed in the Bid; or

7.6.3 Sublet or subcontract any portion of the Work in excess of one-half of one percent (0.5%) of the Contractor's total bid as to which his original bid did not designate a Subcontractor.

7.7 The Contractor shall be responsible for the coordination of the trades, Subcontractors, sub-subcontractors, and material or equipment suppliers working on the Project.

7.7.1 If the Contract is valued at \$1 million or more and uses, or plans to use, state bond funds, then Contractor is responsible for ensuring that first tier Subcontractors holding C-4, C-7, C-10, C-16, C-20, C-34, C-36, C-38, C-42, C-43, and/or C-46 licenses are prequalified by the District to work on the Project pursuant to Public Contract Code section 20111.6.

7.7.2 Contractor is responsible for ensuring that all Subcontractors are properly registered as public works contractors by the Department of Industrial Relations.

7.8 Contractor is solely responsible for settling any differences between the Contractor and its Subcontractor(s) or between Subcontractors.

7.9 Contractor must include in all of its subcontracts the assignment provisions as indicated in the Termination section of these General Conditions.

8. OTHER CONTRACTS/CONTRACTORS

8.1 District reserves the right to let other contracts, and/or to perform work with its own forces, in connection with the Project. Contractor shall afford other contractors reasonable opportunity for introduction and storage of their materials and execution of their work and shall properly coordinate and connect Contractor's Work with the work of other contractors.

8.2 In addition to Contractor's obligation to protect its own Work, Contractor shall protect the work of any other contractor that Contractor encounters while working on the Project.

8.3 If any part of Contractor's Work depends for proper execution or results upon work of District or any other contractor, the Contractor shall inspect and, before proceeding with its Work, promptly report to the District in writing any defects in District's or any other contractor's work that render Contractor's Work unsuitable for proper execution and results. Contractor shall be held accountable for damages to District for District's or any other contractor's work that Contractor failed to inspect or should have inspected. Contractor's failure to inspect and report shall constitute Contractor's acceptance of all District's or any other contractor's work as fit and proper for reception of Contractor's Work, except as to defects that may develop in District's or any other contractor's work after execution of Contractor's Work and not caused by execution of Contractor's Work.

8.4 To ensure proper execution of its subsequent work, Contractor shall measure and inspect work already in place and shall at once report to the District in writing any discrepancy between that executed work and the Contract Documents.

8.5 Contractor shall ascertain to its own satisfaction the scope of the Project and nature of District's or any other contracts that have been or may be awarded by District in prosecution of the Project to the end that Contractor may perform this Contract in light of the other contracts, if any.

8.6 Nothing herein contained shall be interpreted as granting to Contractor exclusive occupancy of the Site, the Premises, or of the Project. Contractor shall not cause any unnecessary hindrance or delay to the use and/or operation(s) of the Premises and/or to District or any other contractor working on the Project. If simultaneous execution of any contract or Premises operation is likely to cause interference with performance of Contractor's Contract, Contractor shall coordinate with those contractor(s), person(s), and/or entity(s) and shall notify the District of the resolution.

9. DRAWINGS AND SPECIFICATIONS

9.1 A complete list of all Drawings that form a part of the Contract is to be found as an index on the Drawings themselves, and/or may be provided to the Contractor and/or in the Table of Contents.

9.2 Materials or Work described in words that so applied have a well-known technical or trade meaning shall be deemed to refer to recognized standards, unless noted otherwise.

9.3 Trade Name or Trade Term. It is not the intention of this Contract to go into detailed descriptions of any materials and/or methods commonly known to the trade under "trade name" or "trade term." The mere mention or notation of "trade name" or "trade term" shall be considered a sufficient notice to Contractor that it will be required to complete the work so named, complete, finished, and operable, with all its appurtenances, according to the best practices of the trade.

9.4 The naming of any material and/or equipment shall mean furnishing and installing of same, including all incidental and accessory items thereto and/or labor therefor, as per best practices of the trade(s) involved, unless specifically noted otherwise.

9.5 Contract Documents are complementary, and what is called for by one shall be binding as if called for by all. As such, Drawings and Specifications are intended to be fully cooperative and to agree. However, if Contractor observes that Drawings and Specifications are in conflict with the Contract Documents, Contractor shall promptly notify District and Architect in writing, and any necessary changes shall be made as provided in the Contract Documents.

9.6 In the case of discrepancy or ambiguity in the Contract Documents, the order of precedence in the Agreement shall prevail. However, in the case of discrepancy or ambiguity solely between and among the Drawings and Specifications, the discrepancy or ambiguity shall be resolved in favor of the interpretation that will provide District with the functionally complete and operable Project described in the Drawings and Specifications. In case of ambiguity, conflict, or lack of information, District will furnish clarifications with reasonable promptness.

9.7 Drawings and Specifications are intended to comply with all laws, ordinances, rules, and regulations of constituted authorities having jurisdiction, and where referred to in the Contract Documents, the laws, ordinances, rules, and regulations shall be considered as a part of the Contract within the limits specified. Contractor shall bear all expense of correcting work done contrary to said laws, ordinances, rules, and regulations.

9.8 As required by Section 4-317(c), Part 1, Title 24, CCR: "Should any existing conditions such as deterioration or non-complying construction be discovered which is not covered by the DSA-approved documents wherein the finished work will not comply with Title 24, California Code of Regulations, a construction change document, or a

separate set of plans and specifications, detailing and specifying the required repair work shall be submitted to and approved by DSA before proceeding with the repair work.”

9.9 Ownership of Drawings

All copies of Plans, Drawings, Designs, Specifications, and copies of other incidental architectural and engineering work, or copies of other Contract Documents furnished by District, are the property of District. They are not to be used by Contractor in other work and, with the exception of signed sets of Contract Documents, are to be returned to District on request at completion of Work, or may be used by District as it may require without any additional costs to District. Neither the Contractor nor any Subcontractor, or material or equipment supplier shall own or claim a copyright in the Drawings, Specifications, and other documents prepared by the Architect. District hereby grants the Contractor, Subcontractors, sub-subcontractors, and material or equipment suppliers a limited license to use applicable portions of the Drawings prepared for the Project in the execution of their Work under the Contract Documents.

10. CONTRACTOR’S SUBMITTALS AND SCHEDULES

Contractor’s submittals shall comply with the provisions and requirements of the Specifications including, without limitation Submittals.

10.1 Schedule of Work, Schedule of Submittals, and Schedule of Values

10.1.1 Within **TEN (10)** calendar days after the date of the Notice to Proceed (unless otherwise specified in the Specifications), the Contractor shall prepare and submit to the District for review, in a form supported by sufficient data to substantiate its accuracy as the District may require:

10.1.1.1 Preliminary Schedule. A preliminary schedule of construction indicating the starting and completion dates of the various stages of the Work, including any information and following any form as may be specified in the Specifications. Once approved by District, this shall become the Construction Schedule. This schedule shall include and identify all tasks that are on the Project’s critical path with a specific determination of the start and completion of each critical path task as well as all Contract milestones and each milestone’s completion date(s) as may be required by the District.

10.1.1.1.1 The District is not required to approve a preliminary schedule of construction with early completion, i.e., one that shows early completion dates for the Work and/or milestones. Contractor shall not be entitled to extra compensation if the District approves a Construction Schedule with an early completion date and Contractor completes the Project beyond the date shown in the schedule but within the Contract Time. A Construction Schedule showing the Work completed in less than the Contract Time, the time between the early completion date and the end of the Contract Time shall be Float.

10.1.1.2 Preliminary Schedule of Values. A preliminary schedule of values for all of the Work, which must include quantities and prices of items aggregating the Contract Price and must subdivide the Work into component parts in sufficient detail to serve as the basis for progress payments during construction. Unless

the Special Conditions contain different limits, this preliminary schedule of values shall include, at a minimum, the following information and the following structure:

10.1.1.2.1 Divided into at least the following categories:

- 10.1.1.2.1.1** Not Used
- 10.1.1.2.1.2** Supervision;
- 10.1.1.2.1.3** General conditions;
- 10.1.1.2.1.4** Layout;
- 10.1.1.2.1.5** Mobilization;
- 10.1.1.2.1.6** Submittals;
- 10.1.1.2.1.7** Bonds and insurance;
- 10.1.1.2.1.8** Close-out/Certification documentation;
- 10.1.1.2.1.9** Demolition;
- 10.1.1.2.1.10** Installation;
- 10.1.1.2.1.11** Rough-in;
- 10.1.1.2.1.12** Finishes;
- 10.1.1.2.1.13** Testing;
- 10.1.1.2.1.14** Punchlist and District acceptance.

10.1.1.2.2 And also divided by each of the following areas:

- 10.1.1.2.2.1** Site work;
- 10.1.1.2.2.2** By each building;
- 10.1.1.2.2.3** By each floor.

10.1.1.2.3 The preliminary schedule of values shall not provide for values any greater than the following percentages of the Contract value:

- 10.1.1.2.3.1** Mobilization and layout combined to equal not more than 1%;
- 10.1.1.2.3.2** Submittals, samples and shop drawings combined to equal not more than 3%;
- 10.1.1.2.3.3** Bonds and insurance combined to equal not more than 2%.
- 10.1.1.2.3.4** Closeout documentation shall have a value in the preliminary schedule of not less than 5%.

10.1.1.2.4 Notwithstanding any provision of the Contract Documents to the contrary, payment of the Contractor's overhead, supervision, general conditions costs, and profit, as reflected in the Cost Breakdown, shall be paid based on percentage complete, with the disbursement of Progress Payments and the Final Payment.

10.1.1.2.5 Contractor shall certify that the preliminary schedule of values as submitted to the District is accurate and reflects the costs as developed in preparing Contractor's bid. For example, without limiting the foregoing, Contractor shall not "front-load" the preliminary schedule of values with dollar amounts greater than the value of activities performed early in the Project.

10.1.1.2.6 The preliminary schedule of values shall be subject to the District's review and approval of the form and content thereof. In the event that the District objects to any portion of the preliminary schedule of values, the District shall notify the Contractor, in writing, of the District's objection(s) to the preliminary schedule of values. Within five (5) calendar days of the date of the District's written objection(s), Contractor shall submit a revised preliminary schedule of values to the District for review and approval. The foregoing procedure for the preparation, review and approval of the preliminary schedule of values shall continue until the District has approved the entirety of the preliminary schedule of values.

10.1.1.2.7 Once the preliminary schedule of values is approved by the District, this shall become the Schedule of Values. The Schedule of Values shall not be thereafter modified or amended by the Contractor without the prior consent and approval of the District, which may be granted or withheld in the sole discretion of the District.

10.1.1.3 Preliminary Schedule of Submittals. A preliminary schedule of submittals, including Shop Drawings, Product Data, and Samples submittals. Once approved by District, this shall become the Submittal Schedule. All submittals shall be forwarded to the District by the date indicated on the approved Submittal Schedule, unless an earlier date is necessary to maintain the Construction Schedule, in which case those submittals shall be forwarded to the District so as not to delay the Construction Schedule. Upon request by the District, Contractor shall provide an electronic copy of all submittals to the District. All submittals shall be submitted no later than 90 days after the Notice to Proceed.

10.1.1.4 Safety Plan.

10.1.1.5 Contractor's Safety Plan specifically adapted for the Project. Contractor's Safety Plan shall comply with the following requirements:

10.1.1.5.1 All applicable requirements of California Division of Occupational Safety and Health ("CalOSHA") and/or of the United States Occupational Safety and Health Administration ("OSHA").

10.1.1.5.2 All provisions regarding Project safety, including all applicable provisions in these General Conditions.

10.1.1.5.3 Contractor's Safety Plan shall be in English and in the language(s) of the Contractor's and its Subcontractors' employees.

10.1.1.6 Complete Registered Subcontractors List. The name, address, telephone number, facsimile number, California State Contractors License number, classification, DIR registration number and monetary value of all Subcontracts of any tier for parties furnishing labor, material, or equipment for completion of the Project.

10.1.2 Contractor must provide all schedules both in hard copy and electronically, in a format (e.g., Microsoft Project or Primavera) approved in advance by the District.

10.1.3 The District will review the schedules submitted and the Contractor shall make changes and corrections in the schedules as requested by the District and resubmit the schedules until approved by the District.

10.1.4 The District shall have the right at any time to revise the schedule of values if, in the District's sole opinion, the schedule of values does not accurately reflect the value of the Work performed.

10.1.5 All schedules must be approved by the District before Contractor can rely on them as a basis for payment.

10.2 Monthly Progress Schedule(s)

10.2.1 Contractor shall provide Monthly Progress Schedule(s) to the District. A Monthly Progress Schedule shall update the approved Construction Schedule or the last Monthly Progress Schedule, showing all work completed and to be completed as well as updating the Registered Subcontractors List. The monthly Progress Schedule shall be sent within the timeframe requested by the District and shall be in a format acceptable to the District and contain a written narrative of the progress of work that month and any changes, delays, or events that may affect the work. The process for District approval of the Monthly Progress Schedule shall be the same as the process for approval of the Construction Schedule.

10.2.2 Contractor shall submit Monthly Progress Schedule(s) with all payment applications.

10.2.3 Contractor must provide all schedules both in hard copy and electronically, in a format (e.g., Microsoft Project or Primavera) approved in advance by the District.

10.2.4 The District will review the schedules submitted and the Contractor shall make changes and corrections in the schedules as requested by the District and resubmit the schedules until approved by the District.

10.2.5 The District shall have the right at any time to revise the schedule of values if, in the District's sole opinion, the schedule of values does not accurately reflect the value of the Work performed.

10.2.6 All schedules must be approved by the District before Contractor can rely on them as a basis for payment.

10.3 Material Safety Data Sheets (MSDS)

Contractor is required to ensure Material Safety Data Sheets are available in a readily accessible place at the Site for any material requiring a Material Safety Data Sheet per the federal "Hazard Communication" standard, or employees' "right to know" law. The Contractor is also required to ensure proper labeling on substances brought onto the job site and that any person working with the material or within the general area of the material is informed of the hazards of the substance and follows proper handling and protection procedures. Two additional copies of the Material Safety Data Sheets shall also be submitted directly to the District.

10.4 Submittals

10.4.1 Architect's favorable review shall neither be construed as a complete check nor relieve the Contractor, Subcontractor, manufacturer, fabricator, or supplier from responsibility for any deficiency that may exist or from any departures or deviations from the requirements of the Contract Documents unless the Contractor has, in writing, called Architect's attention to the deviations at the time of submission and the Architect has given specific written response. "Favorable review" shall mean merely that Architect has no objection to Contractor using, upon Contractor's own full responsibility, plan or method of Work proposed, or furnishing materials or equipment proposed.

11. SITE ACCESS, CONDITIONS, AND REQUIREMENTS

11.1 Site Investigation

Before bidding on this Work, Contractor shall make a careful investigation of the Site and thoroughly familiarize itself with the requirements of the Contract. By the act of submitting a bid for the Work included in this Contract, Contractor shall be deemed to have made a complete study and investigation, and to be familiar with and accepted the existing conditions of the Site.

Prior to commencing the Work, Contractor and the District's representative shall survey the Site to document the condition of the Site. Contractor will record the survey in digital videotape format and provide an electronic copy to the District within fourteen (14) days of the survey. This electronic record shall serve as a basis for determining any damages caused by the Contractor during the Project. The Contractor may also document any pre-existing conditions in writing, provided that both the Contractor and the District's representative agree on said conditions and sign a memorandum documenting the same.

11.2 Soils Investigation Report

11.2.1 When a soils investigation report obtained from test holes at Site or for the Project is available, that report may be available to the Contractor but shall not be a part of this Contract and shall not alleviate or excuse the Contractor's obligation to perform its own investigation. Any information obtained from that report or any information given on Drawings as to subsurface soil condition or to elevations of existing grades or elevations of underlying rock is approximate only, is not guaranteed, does not form a part of this Contract, and Contractor may not rely thereon. By submitting its bid, Contractor acknowledges that it has made visual examination of Site and has made whatever tests Contractor deems appropriate to determine underground condition of soil. Although any such report is not a part of this Contract, recommendations from the report may be included in the Drawings, Specifications, or other Contract Documents. It is Contractor's sole responsibility to thoroughly review all Contract Documents, Drawings, and Specifications.

11.2.2 Contractor agrees that no claim against District will be made by Contractor for damages and hereby waives any rights to damages if, during progress of Work, Contractor encounters subsurface or latent conditions at Site materially differing from those shown on Drawings or indicated in Specifications, or for unknown conditions of an unusual nature that differ materially from those ordinarily

encountered in the work of the character provided for in Plans and Specifications, except as indicated in the provisions of these General Conditions regarding trenches, trenching, and/or existing utility lines.

11.3 Access to Work

District and its representatives shall at all times have access to Work wherever it is in preparation or progress, including storage and fabrication. Contractor shall provide safe and proper facilities for such access so that District's representatives may perform their functions.

11.4 Layout and Field Engineering

11.4.1 All field engineering required for layout of this Work and establishing grades for earthwork operations shall be furnished by Contractor at its expense. This Work shall be done by a qualified, California-registered civil engineer approved in writing by District and Architect. Any required Record and/or As-Built Drawings of Site development shall be prepared by the approved civil engineer.

11.4.2 The Contractor shall be responsible for having ascertained pertinent local conditions such as location, accessibility, and general character of the Site and for having satisfied itself as to the conditions under which the Work is to be performed. Contractor shall follow best practices, including but not limited to potholing to avoid utilities. District shall not be liable for any claim for allowances because of Contractor's error, failure to follow best practices, or negligence in acquainting itself with the conditions at the Site.

11.4.3 Contractor shall protect and preserve established benchmarks and monuments and shall make no changes in locations without the prior written approval of District. Contractor shall replace any benchmarks or monuments that are lost or destroyed subsequent to proper notification of District and with District's approval.

11.5 Utilities

Utilities shall be provided as indicated in the Specifications.

11.6 Sanitary Facilities

Sanitary facilities shall be provided as indicated in the Specifications.

11.7 Surveys

Contractor shall provide surveys done by a California-licensed civil engineer surveyor to determine locations of construction, grading, and site work as required to perform the Work.

11.8 Regional Notification Center

The Contractor, except in an emergency, shall contact the appropriate regional notification center at least two (2) days prior to commencing any excavation if the excavation will be conducted in an area or in a private easement that is known, or

reasonably should be known, to contain subsurface installations other than the underground facilities owned or operated by the District, and obtain an inquiry identification number from that notification center. No excavation shall be commenced and/or carried out by the Contractor unless an inquiry identification number has been assigned to the Contractor or any Subcontractor and the Contractor has given the District the identification number. Any damages arising from Contractor's failure to make appropriate notification shall be at the sole risk and expense of the Contractor. Any delays caused by failure to make appropriate notification shall be at the sole risk of the Contractor and shall not be considered for an extension of the Contract Time.

11.9 Existing Utility Lines

11.9.1 Pursuant to Government Code section 4215, District assumes the responsibility for removal, relocation, and protection of main or trunk utility lines and facilities located on the construction Site at the time of commencement of construction under this Contract with respect to any such utility facilities that are not identified in the Plans and Specifications. Contractor shall not be assessed for liquidated damages for delay in completion of the Project caused by failure of District or the owner of a utility to provide for removal or relocation of such utility facilities.

11.9.2 Locations of existing utilities provided by District shall not be considered exact, but approximate within a reasonable margin and shall not relieve Contractor of responsibilities to exercise reasonable care or costs of repair due to Contractor's failure to do so. District shall compensate Contractor for the costs of locating, repairing damage not due to the failure of Contractor to exercise reasonable care, and removing or relocating such utility facilities not indicated in the Plans and Specifications with reasonable accuracy, and for equipment necessarily idle during such work.

11.9.3 No provision herein shall be construed to preclude assessment against Contractor for any other delays in completion of the Work. Nothing in this Article shall be deemed to require District to indicate the presence of existing service laterals, appurtenances, or other utility lines, within the exception of main or trunk utility lines or whenever the presence of these utilities on the Site of the construction Project can be inferred from the presence of other visible facilities, such as buildings, meter junction boxes, on or adjacent to the Site of the construction.

11.9.4 If Contractor, while performing Work under this Contract, discovers utility facilities not identified by District in Contract Plans and Specifications, Contractor shall immediately notify the District and the utility in writing. The cost of repair for damage to above-mentioned visible facilities without prior written notification to the District shall be borne by the Contractor.

11.10 Notification

Contractor understands, acknowledges and agrees that the purpose for prompt notification to the District pursuant to these provisions is to allow the District to investigate the condition(s) so that the District shall have the opportunity to decide how the District desires to proceed as a result of the condition(s). Accordingly, failure of Contractor to promptly notify the District in writing, pursuant to these provisions, shall constitute Contractor's waiver of any claim for damages or delay incurred as a result of the condition(s).

11.11 Hazardous Materials

Contractor shall comply with all provisions and requirements of the Contract Documents related to hazardous materials including, without limitation, Hazardous Materials Procedures and Requirements.

11.12 No Signs

Neither the Contractor nor any other person or entity shall display any signs not required by law or the Contract Documents at the Site, fences trailers, offices, or elsewhere on the Site without specific prior written approval of the District.

12. TRENCHES

12.1 Trenches Greater Than Five Feet

Pursuant to Labor Code section 6705, if the Contract Price exceeds \$25,000 and involves the excavation of any trench or trenches five (5) feet or more in depth, the Contractor shall, in advance of excavation, promptly submit to the District and/or a registered civil or structural engineer employed by the District or Architect, a detailed plan, stamped by a licensed engineer retained by the Contractor, showing the design of shoring for protection from the hazard of caving ground during the excavation of such trench or trenches.

12.2 Excavation Safety

If such plan varies from the Shoring System Standards established by the Construction Safety Orders, the plan shall be prepared by a registered civil or structural engineer, but in no case shall such plan be less effective than that required by the Construction Safety Orders. No excavation of such trench or trenches shall be commenced until said plan has been accepted by the District or by the person to whom authority to accept has been delegated by the District.

12.3 No Tort Liability of District

Pursuant to Labor Code section 6705, nothing in this Article shall impose tort liability upon the District or any of its employees.

12.4 No Excavation without Permits

The Contractor shall not commence any excavation Work until it has secured all necessary permits including the required CalOSHA excavation/shoring permit. Any permits shall be prominently displayed on the Site prior to the commencement of any excavation.

12.5 Discovery of Hazardous Waste and/or Unusual Conditions

12.5.1 Pursuant to Public Contract Code section 7104, if the Work involves digging trenches or other excavations that extend deeper than four feet below the Surface, the Contractor shall promptly, and before the following conditions are disturbed, notify the District, in writing, of any:

12.5.1.1 Material that the Contractor believes may be material that is hazardous waste, as defined in section 25117 of the Health and Safety Code, is required to be removed to a Class I, Class II, or Class III disposal site in accordance with provisions of existing law.

12.5.1.2 Subsurface or latent physical conditions at the Site differing from those indicated.

12.5.1.3 Unknown physical conditions at the Site of any unusual nature, different materially from those ordinarily encountered and generally recognized as inherent in work of the character provided for in the Contract.

12.5.2 The District shall promptly investigate the conditions, and if it finds that the conditions do materially so differ, or do involve hazardous waste, and cause a decrease or increase in the Contractor's cost of, or the time required for, performance of any part of the Work, shall issue a Change Order under the procedures described herein.

12.5.3 In the event that a dispute arises between District and the Contractor whether the conditions materially differ, or involve hazardous waste, or cause a decrease or increase in the Contractor's cost of, or time required for, performance of any part of the Work, the Contractor shall not be excused from any scheduled completion date provided for by the Contract, but shall proceed with all work to be performed under the Contract. The Contractor shall retain any and all rights provided either by Contract or by law that pertain to the resolution of disputes and protests.

13. INSURANCE AND BONDS

13.1 Insurance

All insurance required of Contractor and/or its Subcontractor(s) shall be at least as broad as the amounts and include the provisions set forth herein.

13.1.1 Commercial General Liability and Automobile Liability Insurance

13.1.1.1 Contractor shall procure and maintain, during the life of this Contract, Commercial General Liability Insurance and Automobile Liability Insurance that shall protect Contractor, District, State, Construction Manager(s), Project Inspector(s), and Architect(s) from all claims for bodily injury, property damage, personal injury, death, advertising injury, and medical payments arising from, or in connection with, operations under this Contract. This coverage shall be provided in a form at least as broad as Insurance Services (ISO) Form CG 0001 11188. Contractor shall ensure that Products Liability and Completed Operations coverage, Fire Damage Liability coverage, and Automobile Liability Insurance coverage including owned, non-owned, and hired automobiles, are included within the above policies and at the required limits, or Contractor shall procure and maintain these coverages separately.

13.1.1.2 Contractor's deductible or self-insured retention for its Commercial General Liability Insurance policy shall not exceed \$25,000 unless approved in writing by District.

13.1.1.3 All such policies shall be written on an occurrence form.

13.1.2 Excess Liability Insurance

13.1.2.1 If Contractor's underlying policy limits are less than required, subject to the District's sole discretion, Contractor may procure and maintain, during the life of this Contract, an Excess Liability Insurance Policy to meet the policy limit requirements of the required policies in order to satisfy, in the aggregate with its underlying policy, the insurance requirements herein.

13.1.2.2 There shall be no gap between the per occurrence amount of any underlying policy and the start of the coverage under the Excess Liability Insurance Policy. Any Excess Liability Insurance Policy shall be written on a following form and shall protect Contractor, District, State, Construction Manager(s), Project Manager(s), and Architect(s) in amounts and including the provisions as set forth in the Supplementary Conditions (if any) and/or Special Conditions, and that complies with all requirements for Commercial General Liability and Automobile Liability and Employers' Liability Insurance.

13.1.2.3 The District, in its sole discretion, may accept the Excess Liability Insurance Policy that brings Contractor's primary limits to the minimum requirements herein.

13.1.3 Subcontractor(s):

Contractor shall require its Subcontractor(s), if any, to procure and maintain Commercial General Liability Insurance, Automobile Liability Insurance, and Excess Liability Insurance (if Subcontractor elects to satisfy, in part the insurance required herein by procuring and maintaining an Excess Liability Insurance Policy) with forms of coverage and limits equal to the amounts required of the Contractor.

13.1.4 Workers' Compensation and Employers' Liability Insurance

13.1.4.1 In accordance with provisions of section 3700 of the California Labor Code, the Contractor and every Subcontractor shall be required to secure the payment of compensation to its employees.

13.1.4.2 Contractor shall procure and maintain, during the life of this Contract, Workers' Compensation Insurance and Employers' Liability Insurance for all of its employees engaged in work under this Contract, on/or at the Site of the Project. This coverage shall cover, at a minimum, medical and surgical treatment, disability benefits, rehabilitation therapy, and survivors' death benefits. Contractor shall require its Subcontractor(s), if any, to procure and maintain Workers' Compensation Insurance and Employers' Liability Insurance for all employees of Subcontractor(s). Any class of employee or employees not covered by a Subcontractor's insurance shall be covered by Contractor's insurance. If any class of employee or employee engaged in Work under this Contract, on or at the Site of the Project, is not protected under the Workers' Compensation Insurance, Contractor shall provide, or shall cause a Subcontractor to provide, adequate insurance coverage for the protection of any employee(s) not otherwise protected before any of those employee(s) commence work.

13.1.5 Builder's Risk Insurance: Builder's Risk "All Risk" Insurance

Contractor shall procure and maintain, during the life of this Contract, Builder's Risk (Course of Construction), or similar first party property coverage acceptable to the District, issued on a replacement cost value basis. The cost shall be consistent with the total replacement cost of all insurable Work of the Project included within the Contract Documents. Coverage is to insure against all risks of accidental physical loss and shall include without limitation the perils of vandalism and/or malicious mischief (both without any limitation regarding vacancy or occupancy), sprinkler leakage, civil authority, theft, sonic disturbance, earthquake, flood, collapse, wind, rain, dust, fire, war, terrorism, lightning, smoke, and rioting. Coverage shall include debris removal, demolition, increased costs due to enforcement of all applicable ordinances and/or laws in the repair and replacement of damaged and undamaged portions of the property, and reasonable costs for the Architect's and engineering services and expenses required as a result of any insured loss upon the Work and Project, including completed Work and Work in progress, to the full insurable value thereof.

13.1.6 Pollution Liability Insurance

13.1.6.1 Contractor shall procure and maintain Pollution Liability Insurance that shall protect Contractor, District, State, Construction Manager(s), Project Inspector(s), and Architect(s) from all claims for bodily injury, property damage, including natural resource damage, cleanup costs, removal, storage, disposal, and/or use of the pollutant arising from operations under this Contract, and defense, including costs and expenses incurred in the investigation, defense, or settlement of claims. Coverage shall apply to sudden and/or gradual pollution conditions resulting from the escape or release of smoke, vapors, fumes, acids, alkalis, toxic chemicals, liquids, or gases, natural gas, waste materials, or other irritants, contaminants, or pollutants, including asbestos. This coverage shall be provided in a form at least as broad as Insurance Services Offices, Inc. (ISO) Form CG 2415, or Contractor shall procure and maintain these coverages separately.

13.1.6.2 Contractor warrants that any retroactive date applicable to coverage under the policy shall predate the effective date of the Contract and that continuous coverage will be maintained or an extended reporting or discovery period will be exercised for a period of three (3) years, beginning from the time that the Work under the Contract is completed.

13.1.6.3 If Contractor is responsible for removing any pollutants from a site, then Contractor shall ensure that Any Auto, including owned, non-owned, and hired, is included within the above policies and at the required limits, to cover its automobile exposure from transporting the pollutants from the site to an approved disposal site. This coverage shall include the Motor Carrier Act Endorsement, MCS 90.

13.1.7 Proof of Insurance and Other Requirements: Endorsements and Certificates

13.1.7.1 Contractor shall not commence Work nor shall it allow any Subcontractor to commence Work under this Contract, until Contractor and its

Subcontractor(s) have procured all required insurance and Contractor has delivered in duplicate to the District complete endorsements (or entire insurance policies) and certificates indicating the required coverages have been obtained, and the District has approved these documents.

13.1.7.2 Endorsements, certificates, and insurance policies shall include the following:

13.1.7.2.1 A clause stating the following, or other language acceptable to the District:

"This policy shall not be canceled until written notice to District, Architect, and Construction Manager stating date of the cancellation by the insurance carrier. Date of cancellation may not be less than thirty (30) days after date of mailing notice."

13.1.7.2.2 Language stating in particular those insured, extent of insurance, location and operation to which insurance applies, expiration date, to whom cancellation and reduction notice will be sent, and length of notice period.

13.1.7.2.3 All endorsements, certificates and insurance policies shall state that District, its trustees, employees and agents, the State of California, Construction Manager(s), Project Manager(s), Inspector(s) and Architect(s) are named additional insureds under all policies except Workers' Compensation Insurance and Employers' Liability Insurance.

13.1.7.2.4 All endorsements shall waive any right to subrogation against any of the named additional insureds.

13.1.7.2.5 Contractor's and Subcontractors' insurance policy(s) shall be primary and non-contributory to any insurance or self-insurance maintained by District, its trustees, employees and/or agents, the State of California, Construction Manager(s), Project Manager(s), Inspector(s), and/or Architect(s).

13.1.7.2.6 Contractor's insurance limit shall apply separately to each insured against whom a claim is made or suit is brought.

13.1.7.3 No policy shall be amended, canceled or modified, and the coverage amounts shall not be reduced, until Contractor or Contractor's broker has provided written notice to District, Architect(s), and Construction Manager(s) stating date of the amendment, modification, cancellation or reduction, and a description of the change. Date of amendment, modification, cancellation or reduction may not be less than thirty (30) days after date of mailing notice.

13.1.7.4 Insurance written on a "claims made" basis shall be retroactive to a date that coincides with or precedes Contractor's commencement of Work, including subsequent policies purchased as renewals or replacements. Said policy is to be renewed by the Contractor and all Subcontractors for a period of five (5) years following completion of the Work or termination of this Agreement. Such insurance must have the same coverage and limits as the policy that was in

effect during the term of this Agreement, and will cover the Contractor and all Subcontractors for all claims made.

13.1.7.5 Unless otherwise stated in the Special Conditions, all of Contractor’s insurance shall be with insurance companies with an A.M. Best rating of no less than **A: VII**.

13.1.7.6 The insurance requirements set forth herein shall in no way limit the Contractor’s liability arising out of or relating to the performance of the Work or related activities.

13.1.7.7 Failure of Contractor and/or its Subcontractor(s) to comply with the insurance requirements herein shall be deemed a material breach of the Contract.

13.1.8 Insurance Policy Limits

13.1.8.1 Unless different limits are indicated in the Special Conditions, the limits of insurance shall not be less than the following amounts:

Commercial General Liability	Product Liability and Completed Operations, Fire Damage Liability – Split Limit	\$1,000,000 per occurrence; \$2,000,000 aggregate
Automobile Liability – Any Auto	Combined Single Limit	Personal vehicles: \$500,000 Commercial vehicles: \$1,000,000
Workers’ Compensation		Statutory limits pursuant to State law
Employer’s Liability		\$1,000,000
Builder’s Risk (Course of Construction)		Issued for the value and scope of Work indicated herein
Pollution Liability		\$1,000,000 per claim; \$2,000,000 aggregate

13.1.8.2 If Contractor normally carries insurance in an amount greater than the minimum amounts required by District, that greater amount shall become the minimum required amount of insurance for purposes of the Contract. Therefore, Contractor hereby acknowledges and agrees that all insurance carried by it shall be deemed liability coverage for all actions it performs in connection with the Contract.

13.2 Contract Security - Bonds

13.2.1 Contractor shall furnish two surety bonds issued by a California admitted surety insurer as follows:

13.2.1.1 Performance Bond: A bond in an amount at least equal to one hundred percent (100%) of Contract Price as security for faithful performance of this Contract.

13.2.1.2 Payment Bond: A bond in an amount at least equal to one hundred percent (100%) of the Contract Price as security for payment of persons performing labor and/or furnishing materials in connection with this Contract.

13.2.2 Cost of bonds shall be included in the Bid and Contract Price.

13.2.3 All bonds related to this Project shall be in the forms set forth in these Contract Documents and shall comply with all requirements of the Contract Documents, including, without limitation, the bond forms.

14. WARRANTY/GUARANTEE/INDEMNITY

14.1 Warranty/Guarantee

14.1.1 The Contractor shall obtain and preserve for the benefit of the District, manufacturer's warranties on materials, fixtures, and equipment incorporated into the Work.

14.1.2 In addition to guarantees required elsewhere, Contractor shall, and hereby does guarantee and warrant all Work furnished on the job against all defects for a period of **TWO (2)** years after the later of the following dates, unless a longer period is provided for in the Contract Documents:

14.1.2.1 The acceptance by the District's governing board of the Work, subject to these General Conditions, or

14.1.2.2 The date that commissioning for the Project, if any, was completed.

At the District's sole option, Contractor shall repair or replace any and all of that Work, together with any other Work that may be displaced in so doing, that may prove defective in workmanship and/or materials within a **TWO (2)** year period from date of completion as defined above, unless a longer period is provided for in the Contract Documents, without expense whatsoever to District. In the event of failure of Contractor and/or Surety to commence and pursue with diligence said replacements or repairs within ten (10) days after being notified in writing, Contractor and Surety hereby acknowledge and agree that District is authorized to proceed to have defects repaired and made good at expense of Contractor and/or Surety who hereby agree to pay costs and charges therefore immediately on demand.

14.1.3 If, in the opinion of District, defective work creates a dangerous condition or requires immediate correction or attention to prevent further loss to District or to prevent interruption of District operations, District will attempt to give the notice

required above. If Contractor or Surety cannot be contacted or neither complies with District's request for correction within a reasonable time as determined by District, District may, notwithstanding the above provision, proceed to make any and all corrections and/or provide attentions the District believes are necessary. The costs of correction or attention shall be charged against Contractor and Surety of the guarantees provided in this Article or elsewhere in this Contract.

14.1.4 The above provisions do not in any way limit the guarantees on any items for which a longer guarantee is specified or on any items for which a manufacturer gives a guarantee for a longer period. Contractor shall furnish to District all appropriate guarantee or warranty certificates as indicated in the Specifications or upon request by District.

14.1.5 Nothing herein shall limit any other rights or remedies available to District.

14.2 Indemnity and Defense

14.2.1 To the furthest extent permitted by California law, the Contractor shall indemnify, keep and hold harmless the District, the Architect(s), and the Construction Manager(s), their respective consultants, separate contractors, board members, officers, representatives, agents, and employees, in both individual and official capacities ("Indemnitees"), against all suits, claims, injury, damages, losses, and expenses ("Claims"), including but not limited to attorney's fees, caused by, arising out of, resulting from, or incidental to, in whole or in part, the performance of the Work under this Contract by the Contractor, its Subcontractors, vendors, or suppliers. However, the Contractor's indemnification and hold harmless obligation shall be reduced by the proportion of the Indemnitees' and/or Architect's liability to the extent the Claim(s) is/are caused by the sole negligence, active negligence, or willful misconduct of the Indemnitees, and/or defects in design furnished by the Architect, as found by a court or arbitrator of competent jurisdiction. This indemnification and hold harmless obligation of the Contractor shall not be construed to negate, abridge, or otherwise reduce any right or obligation of indemnity that would otherwise exist or arise as to any Indemnitee or other person described herein. This indemnification and hold harmless obligation includes, but is not limited to, any failure or alleged failure by Contractor to comply with any provision of law, any failure or alleged failure to timely and properly fulfill all of its obligations under the Contract Documents in strict accordance with their terms, and without limitation, any failure or alleged failure of Contractor's obligations regarding any stop payment notice actions or liens, including Civil Wage and Penalty Assessments and/or Orders by the DIR.

14.2.2 To the furthest extent permitted by California law, Contractor shall also defend Indemnitees, at its own expense, including but not limited to attorneys' fees and costs, against all Claims caused by, arising out of, resulting from, or incidental to, in whole or in part, the performance of the Work under this Contract by the Contractor, its Subcontractors, vendors, or suppliers. However, without impacting Contractor's obligation to provide an immediate and ongoing defense of Indemnitees, the Contractor's defense obligation shall be retroactively reduced by the proportion of the Indemnitees' and/or Architect's liability to the extent caused by the sole negligence, active negligence, or willful misconduct of the Indemnitees, and/or defects in design furnished by the Architect, as found by a court or arbitrator of competent jurisdiction. The District shall have the right to accept or reject any legal

representation that Contractor proposes to defend the Indemnitees. If any Indemnatee provides its own defense due to failure to timely respond to tender of defense, rejection of tender of defense, or conflict of interest of proposed counsel, Contractor shall reimburse such Indemnatee for any expenditures. Contractor's defense obligation shall not be construed to negate, abridge, or otherwise reduce any right or obligation of defense that would otherwise exist as to any Indemnatee or other person described herein. Contractor's defense obligation includes, but is not limited to, any failure or alleged failure by Contractor to comply with any provision of law, any failure or alleged failure to timely and properly fulfill all of its obligations under the Contract Documents in strict accordance with their terms, and without limitation, any failure or alleged failure of Contractor's obligations regarding any stop payment notice actions or liens, including Civil Wage and Penalty Assessments and/or Orders by the DIR. The Contractor shall give prompt notice to the District in the event of any Claim(s).

14.2.3 Without limitation of the provisions herein, if the Contractor's obligation to indemnify and hold harmless the Indemnitees or its obligation to defend Indemnitees as provided herein shall be determined to be void or unenforceable, in whole or in part, it is the intention of the parties that these circumstances shall not otherwise affect the validity or enforceability of the Contractor's agreement to indemnify, defend, and hold harmless the rest of the Indemnitees, as provided herein. Further, the Contractor shall be and remain fully liable on its agreements and obligations herein to the fullest extent permitted by law.

14.2.4 Pursuant to Public Contract Code section 9201, the District shall provide timely notification to Contractor of the receipt of any third-party Claim relating to this Contract. The District shall be entitled to recover its reasonable costs incurred in providing said notification.

14.2.5 In any and all Claims against any of the Indemnitees by any employee of the Contractor, any Subcontractor, anyone directly or indirectly employed by any of them or anyone for whose acts any of them may be liable, the Contractor's indemnification obligation herein shall not be limited in any way by any limitation on the amount or type of damages, compensation, or benefits payable by or for the Contractor or any Subcontractor under workers' compensation acts, disability benefit acts, or other employee benefit acts.

14.2.6 The District may retain so much of the moneys due the Contractor as shall be considered necessary, until disposition of any such Claims or until the District, Architect(s) and Construction Manager(s) have received written agreement from the Contractor that they will unconditionally defend the District, Architect(s) and Construction Manager(s), their respective officers, agents and employees, and pay any damages due by reason of settlement or judgment.

14.2.7 The Contractor's defense and indemnification obligations hereunder shall survive the completion of Work, the warranty/guarantee period, and the termination of the Contract.

15. TIME

15.1 Notice to Proceed

15.1.1 District may issue a Notice to Proceed within ninety (90) days from the date of the Notice of Award. Once Contractor has received the Notice to Proceed, Contractor shall complete the Work within the period of time indicated in the Contract Documents.

15.1.2 In the event that the District desires to postpone issuing the Notice to Proceed beyond ninety (90) days from the date of the Notice of Award, it is expressly understood that with reasonable notice to the Contractor, the District may postpone issuing the Notice to Proceed. It is further expressly understood by Contractor that Contractor shall not be entitled to any claim of additional compensation as a result of the postponement of the issuance of the Notice to Proceed.

15.1.3 If the Contractor believes that a postponement of issuance of the Notice to Proceed will cause a hardship to Contractor, Contractor may terminate the Contract. Contractor's termination due to a postponement shall be by written notice to District within ten (10) days after receipt by Contractor of District's notice of postponement. It is further understood by Contractor that in the event that Contractor terminates the Contract as a result of postponement by the District, the District shall only be obligated to pay Contractor for the Work that Contractor had performed at the time of notification of postponement. Should Contractor terminate the Contract as a result of a notice of postponement, District shall have the authority to award the Contract to the next lowest responsive responsible bidder.

15.2 Computation of Time / Adverse Weather

15.2.1 The Contractor will only be allowed a time extension for Adverse Weather conditions if requested by Contractor in compliance with the time extension request procedures and only if all the following conditions are met:

15.2.1.1 The weather conditions constitute Adverse Weather, as defined herein;

15.2.1.2 Contractor can verify that the Adverse Weather caused delays in excess of five (5) hours of the indicated labor required to complete the scheduled tasks of Work on the day affected by the Adverse Weather;

15.2.1.3 The Contractor's crew is dismissed as a result of the Adverse Weather;

15.2.1.4 Said delay adversely affects the critical path in the Construction Schedule; and

15.2.1.5 The number of days of Adverse Weather exceeds the following parameters:

January	<u>7</u>	July	<u>0</u>
February	<u>6</u>	August	<u>0</u>
March	<u>7</u>	September	<u>0</u>
April	<u>4</u>	October	<u>2</u>
May	<u>2</u>	November	<u>5</u>
June	<u>0</u>	December	<u>7</u>

15.2.2 If the aforementioned conditions are met, a non-compensable day-for-day extension will only be allowed for those days in excess of those indicated herein.

15.2.3 The Contractor shall work seven (7) days per week, if necessary, irrespective of inclement weather, to maintain access and the Construction Schedule, and to protect the Work under construction from the effects of Adverse Weather, all at no further cost to the District.

15.2.4 The Contract Time has been determined with consideration given to the average climate weather conditions prevailing in the County in which the Project is located.

15.3 Hours of Work

15.3.1 Sufficient Forces

Contractor and Subcontractors shall continuously furnish sufficient and competent work forces with the required levels of familiarity with the Project and skill, training and experience to ensure the prosecution of the Work in accordance with the Construction Schedule.

15.3.2 Performance During Working Hours

Work shall be performed during regular working hours as permitted by the appropriate governmental agency except that in the event of an emergency, or when required to complete the Work in accordance with job progress, Work may be performed outside of regular working hours with the advance written consent of the District and approval of any required governmental agencies.

15.3.3 No Work during State Testing

Contractor shall, at no additional cost to the District and at the District’s request, coordinate its Work to not disturb District students including, without limitation, not performing any Work when students at the Site are taking State or Federally-required tests. The District or District’s Representative will provide Contractor with a

schedule of test dates concurrent with the District's issuance of the Notice to Proceed, or as soon as test dates are made available to the District.

15.4 Progress and Completion

15.4.1 Time of the Essence

Time limits stated in the Contract Documents are of the essence to the Contract. By executing the Agreement, the Contractor confirms that the Contract Time is a reasonable period for performing the Work.

15.4.2 No Commencement Without Insurance or Bonds

The Contractor shall not commence operations on the Project or elsewhere prior to the effective date of insurance and bonds. The date of commencement of the Work shall not be changed by the effective date of such insurance or bonds. If Contractor commences Work without insurance and bonds, all Work is performed at Contractor's peril and shall not be compensable until and unless Contractor secures bonds and insurance pursuant to the terms of the Contract Documents and subject to District claim for damages.

15.5 Schedule

Contractor shall provide to District, Construction Manager, and Architect a schedule in conformance with the Contract Documents and as required in the Notice to Proceed and the Contractor's Submittals and Schedules section of these General Conditions.

15.6 Expeditious Completion

The Contractor shall proceed expeditiously with adequate forces and shall achieve Completion within the Contract Time.

16. EXTENSIONS OF TIME – LIQUIDATED DAMAGES

16.1 Liquidated Damages

Contractor and District hereby agree that the exact amount of damages for failure to complete the Work within the time specified is extremely difficult or impossible to determine. If the Work is not completed within the time specified in the Contract Documents, it is understood that the District will suffer damage. It being impractical and unfeasible to determine the amount of actual damage, it is agreed the Contractor shall pay to District as fixed and liquidated damages, and not as a penalty, the amount set forth in the Agreement for each calendar day of delay in completion. Contractor and its Surety shall be liable for the amount thereof pursuant to Government Code section 53069.85.

16.2 Excusable Delay

16.2.1 Contractor shall not be charged for liquidated damages because of any delays in completion of the Work which are not the fault of Contractor or its Subcontractors, including acts of God as defined in Public Contract Code section 7105, acts of enemy, epidemics, and quarantine restrictions. Contractor shall, within

five (5) calendar days of beginning of any delay, notify District in writing of causes of delay including documentation and facts explaining the delay and the direct correlation between the cause and effect. District shall review the facts and extent of any delay and shall grant extension(s) of time for completing Work when, in its judgment, the findings of fact justify an extension. Extension(s) of time shall apply only to that portion of Work affected by delay, and shall not apply to other portions of Work not so affected. An extension of time may only be granted if Contractor has timely submitted the Construction Schedule as required herein.

16.2.2 Contractor shall notify the District pursuant to the claims provisions in these General Conditions of any anticipated delay and its cause. Following submission of a claim, the District may determine whether the delay is to be considered avoidable or unavoidable, how long it continues, and to what extent the prosecution and completion of the Work might be delayed thereby.

16.2.3 In the event the Contractor requests an extension of Contract Time for unavoidable delay, such request shall be submitted in accordance with the provisions in the Contract Documents governing changes in Work. When requesting time, requests must be submitted with full justification and documentation. If the Contractor fails to submit justification, it waives its right to a time extension at a later date. Such justification must be based on the official Construction Schedule as updated at the time of occurrence of the delay or execution of Work related to any changes to the Scope of Work. Any claim for delay must include the following information as support, without limitation:

16.2.3.1 The duration of the activity relating to the changes in the Work and the resources (manpower, equipment, material, etc.) required to perform the activities within the stated duration.

16.2.3.2 Specific logical ties to the Contract Schedule for the proposed changes and/or delay showing the activity/activities in the Construction Schedule that are affected by the change and/or delay. In particular, Contractor must show an actual impact to the schedule, after making a good faith effort to mitigate the delay by rescheduling the work, by providing an analysis of the schedule ("Time Impact Analysis"). Such Time Impact Analysis shall describe in detail the cause and effect of the delay and the impact on the critical dates in the Project schedule. (A portion of any delay of seven (7) days or more must be provided.)

16.2.3.3 A recovery schedule must be submitted within twenty (20) calendar days of written notification to the District of causes of delay.

16.3 No Additional Compensation for Delays Within Contractor's Control

16.3.1 Contractor is aware that governmental agencies, including, without limitation, the Division of the State Architect, the Department of General Services, gas companies, electrical utility companies, water districts, and other agencies may have to approve Contractor-prepared drawings or approve a proposed installation. Accordingly, Contractor shall include in its bid, time for possible review of its drawings and for reasonable delays and damages that may be caused by such agencies. Thus, Contractor is not entitled to make a claim for damages or delays arising from the review of Contractor's drawings.

16.3.2 Contractor shall only be entitled to compensation for delay when all of the following conditions are met:

16.3.2.1 The District is responsible for the delay;

16.3.2.2 The delay is unreasonable under the circumstances involved;

16.3.2.3 The delay was not within the contemplation of the District and Contractor;

16.3.2.4 The delay could not have been avoided or mitigated by Contractor's reasonable diligence; and

16.3.2.5 Contractor timely complies with the claims procedure of the Contract Documents.

16.3.3 Where a change in the Work extends the Contract Time, Contractor may request and recover additional, actual direct costs, provided that Contractor can demonstrate such additional costs are:

16.3.3.1 Actually incurred performing the Work;

16.3.3.2 Not compensated by the Markup allowed; and

16.3.3.3 Directly result from the extended Contract Time.

Contractor shall comply with all required procedures, documentation and time requirements in the Contract Documents. Contractor may not seek or recover such costs using formulas (e.g. Eichleay, labor factors).

16.4 Float or Slack in the Schedule

Float or slack is the amount of time between the early start date and the late start date, or the early finish date and the late finish date, of any of the activities in the schedule. Float or slack is not for the exclusive use of or benefit of either the District or the Contractor, but its use shall be determined solely by the District.

17. CHANGES IN THE WORK

17.1 No Changes Without Authorization

17.1.1 There shall be no change whatsoever in the Drawings, Specifications, or in the Work without an executed Change Order or a written Construction Change Directive authorized by the District as herein provided. District shall not be liable for the cost of any extra work or any substitutions, changes, additions, omissions, or deviations from the Drawings and Specifications unless the District's governing board has authorized the same and the cost thereof has been approved in writing by Change Order or Construction Change Directive in advance of the changed Work being performed. No extension of time for performance of the Work shall be allowed hereunder unless claim for such extension is made at the time changes in the Work are ordered, and such time duly adjusted and approved in writing in the Change Order or Construction Change Directive. Contractor shall be responsible for any

costs incurred by the District for professional services and DSA fees and/or delay to the Project Schedule, if any, for DSA to review any request for changes to the DSA approved plans and specifications for the convenience of the Contractor and/or to accommodate the Contractor's means and methods. The provisions of the Contract Documents shall apply to all such changes, additions, and omissions with the same effect as if originally embodied in the Drawings and Specifications.

17.1.2 Contractor shall perform immediately all work that has been authorized by a fully executed Change Order or Construction Change Directive. Contractor shall be fully responsible for any and all delays and/or expenses caused by Contractor's failure to expeditiously perform this Work.

17.1.3 Should any Change Order result in an increase in the Contract Price or extend the Contract Time, the cost of or length of extension in that Change Order shall be agreed to, in writing, by the District in advance of the Work by Contractor, and shall be subject to the monetary limitations set forth in Public Contract Code section 20118.4. In the event that Contractor proceeds with any change in Work without a Change Order executed by the District or Construction Change Directive, Contractor waives any claim of additional compensation or time for that additional work. Under no circumstances shall Contractor be entitled to any claim of additional compensation or time not expressly requested by Contractor in a Proposed Change Order or approved by District in an executed Change Order.

17.1.4 A Change Order or Construction Change Directive will become effective when approved by the Board, notwithstanding that Contractor has not signed it. A Change Order or Construction Change Directive will become effective without Contractor's signature provided District indicates it as a "Unilateral Change Order". Any dispute as to the adjustment in the Contract Price or Contract Time, if any, of the Unilateral Change Order shall be resolved pursuant to the Payment and Claims and Disputes provisions herein.

17.1.5 Contractor understands, acknowledges, and agrees that the reason for District authorization is so that District may have an opportunity to analyze the Work and decide whether the District shall proceed with the Change Order or alter the Project so that a change in Work becomes unnecessary.

17.2 Architect Authority

The Architect will have authority to order minor changes in the Work not involving any adjustment in the Contract Price, or an extension of the Contract Time, or a change that is inconsistent with the intent of the Contract Documents. These changes shall be effected by written Change Order, Construction Change Directive, by Architect's response(s) to RFI(s), or by Architect's Supplemental Instructions ("ASI").

17.3 Change Orders

17.3.1 A Change Order is a written instrument prepared and issued by the District and/or the Architect and signed by the District (as authorized by the District's Governing Board), the Contractor, the Architect, and approved by the Project Inspector (if necessary) and DSA (if necessary), stating their agreement regarding all of the following:

17.3.1.1 A description of a change in the Work;

17.3.1.2 The amount of the adjustment in the Contract Price, if any; and

17.3.1.3 The extent of the adjustment in the Contract Time, if any.

17.4 Construction Change Directives

17.4.1 A Construction Change Directive is a written order prepared and issued by the District, the Construction Manager, and/or the Architect and signed by the District and the Architect, directing a change in the Work. The District may, as provided by law, by Construction Change Directive and without invalidating the Contract, order changes in the Work consisting of additions, deletions, or other revisions. The adjustment to the Contract Price or Time, if any, is subject to the provisions of this section regarding Changes in the Work. If all or a portion of the Project is being funded by funds requiring approval by the State Allocation Board ("SAB"), these revisions may be subject to compensation once approval of same is received and funded by the SAB, and funds are released by the Office of Public School Construction ("OPSC"). Any dispute as to the adjustment in the Contract Price, if any, of the Construction Change Directive or timing of payment shall be resolved pursuant to the Payment and Claims and Disputes provisions herein.

17.4.2 The District may issue a Construction Change Directive in the absence of agreement on the terms of a Change Order.

17.5 Force Account Directives

17.5.1 When work, for which a definite price has not been agreed upon in advance, is to be paid for on a force account basis, all direct costs necessarily incurred and paid by the Contractor for labor, material, and equipment used in the performance of that Work, shall be subject to the approval of the District and compensation will be determined as set forth herein.

17.5.2 The District will issue a Force Account Directive to proceed with the Work on a force account basis, and a not-to-exceed budget will be established by the District.

17.5.3 All requirements regarding direct cost for labor, labor burden, material, equipment, and markups on direct costs for overhead and profit described in this section shall apply to Force Account Directives. However, the District will only pay for actual costs verified in the field by the District or its authorized representative(s) on a daily basis.

17.5.4 The Contractor shall be responsible for all cost related to the administration of Force Account Directive. The markup for overhead and profit for Contractor modifications shall be full compensation to the Contractor to administer Force Account Directive, and Contractor shall not be entitled to separately recover additional amounts for overhead and/or profit.

17.5.5 The Contractor shall notify the District or its authorized representative(s) at least twenty-four (24) hours prior to proceeding with any of the force account work. Furthermore, the Contractor shall notify the District when it has consumed

eighty percent (80%) of the budget, and shall not exceed the budget unless specifically authorized in writing by the District. The Contractor will not be compensated for force account work in the event that the Contractor fails to timely notify the District regarding the commencement of force account work, or exceeding the force account budget.

17.5.6 The Contractor shall diligently proceed with the work, and on a daily basis, submit a daily force account report using Document 00 63 47, "Daily Force Account Report," no later than 5:00 p.m. each day. The report shall contain a detailed itemization of the daily labor, material, and equipment used on the force account work only. The names of the individuals performing the force account work shall be included on the daily force account reports. The type and model of equipment shall be identified and listed. The District will review the information contained in the reports, and sign the reports no later than the next work day, and return a copy of the report to the Contractor for their records. The District will not sign, nor will the Contractor receive compensation for work the District cannot verify. The Contractor will provide a weekly force account summary indicating the status of each Force Account Directive in terms of percent complete of the not-to-exceed budget and the estimated percent complete of the work.

17.5.7 In the event the Contractor and the District reach a written agreement on a set cost for the work while the work is proceeding based on a Force Account Directive, the Contractor's signed daily force account reports shall be discontinued and all previously signed reports shall be invalid.

17.6 Price Request

17.6.1 Definition of Price Request

A Price Request is a written request prepared by the Architect requesting the Contractor to submit to the District and the Architect an estimate of the effect of a proposed change in the Work on the Contract Price and the Contract Time.

17.6.2 Scope of Price Request

A Price Request shall contain adequate information, including any necessary Drawings and Specifications, to enable Contractor to provide the cost breakdowns required herein. The Contractor shall not be entitled to any additional compensation for preparing a response to a Price Request, whether ultimately accepted or not.

17.7 Proposed Change Order

17.7.1 Definition of Proposed Change Order

A Proposed Change Order ("PCO") is a written request prepared by the Contractor requesting that the District and the Architect issue a Change Order based upon a proposed change to the Work.

17.7.2 Changes in Contract Price

A PCO shall include breakdowns and backup documentation pursuant to the revisions herein and sufficient, in the District's judgment, to validate any change in Contract

Price. In no case shall Contractor or any of its Subcontractors be permitted to reserve rights for additional compensation for Change Order Work.

17.7.3 Changes in Time

A PCO shall also include any changes in time required to complete the Project. Any additional time requested shall not be the number of days to make the proposed change, but must be based upon the impact to the Construction Schedule as defined in the Contract Documents. The Contractor shall justify the proposed change in time by submittal of a schedule analysis that accurately shows the impact of the change on the critical path of the Construction Schedule ("Time Impact Analysis"). If Contractor fails to request a time extension in a PCO, including the Time Impact Analysis, then the Contractor is thereafter precluded from requesting, and waives any right to request, additional time and/or claim a delay. In no case shall Contractor or any of its Subcontractors be permitted to reserve rights for additional time for Change Order Work. A PCO that leaves the amount of time requested blank, or states that such time requested is "to be determined", is not permitted and shall also constitute a waiver of any right to request additional time and/or claim a delay.

17.7.4 Unknown and/or Unforeseen Conditions

If there is an Allowance, then Contractor must submit a Request for Allowance Expenditure Directive, including supporting documentation as described below, to receive authorization for the release of funds from the Allowance. Allowance Expenditure Directives shall be based on Contractor's costs, without overhead and profit, for products, delivery, installation, labor, insurance, payroll, taxes, bonding and equipment rental will be included in Allowance Expenditure Directive authorizing expenditure of funds from this Allowance. No overhead and profit shall be added to the Allowance Expenditure Directive. If cost of the unforeseen condition(s) exceed the Allowance, Contractor must submit a PCO for amounts in excess of the Allowance requesting an increase in Contract Price and/or Contract Time that is based at least partially on Contractor's assertion that Contractor has encountered unknown and/or unforeseen condition(s) on the Project, then Contractor shall base the PCO on provable information that, beyond a reasonable doubt and to the District's satisfaction, demonstrates that the unknown and/or unforeseen condition(s) were actually unknown and/or unforeseen and that the condition(s) were reasonably unknown and/or unforeseen. If not, the District shall deny the PCO as unsubstantiated, and the Contractor shall complete the Project without any increase in Contract Price and/or Contract Time based on that PCO.

17.7.5 Time to Submit Proposed Change Order

Contractor shall submit its PCO within five (5) working days of the date Contractor discovers, or reasonably should have discovered, the circumstances giving rise to the PCO, unless additional time to submit a PCO is granted in writing by the District. Time is of the essence in Contractor's submission of PCOs so that the District can promptly investigate the basis for the PCO. Accordingly, if Contractor fails to submit its PCO within this timeframe, Contractor waives, releases, and discharges any right

to assert or claim any entitlement to an adjustment of the Contract Price and/or Time based on circumstances giving rise to the PCO.

17.7.6 Proposed Change Order Certification

In submitting a PCO, Contractor certifies and affirms that the cost and/or time request is submitted in good faith, that the cost and/or time request is accurate and in accordance with the provisions of the Contract Documents, and the Contractor submits the cost and/or request for extension of time recognizing the significant civil penalties and treble damages which follow from making a false claim or presenting a false claim under Government Code section 12650 et seq.

It is expressly understood that the value of the extra Work or changes expressly includes any and all of the Contractor's costs and expenses, direct and indirect, resulting from additional time required on the Project or resulting from delay to the Project including, without limitation, cumulative impacts. Contractor is not entitled to separately recover amounts for overhead or other indirect costs. Any costs, expenses, damages, or time extensions not included are deemed waived.

[THE REMAINDER OF THIS PAGE LEFT BLANK INTENTIONALLY]

17.8 Format for Proposed Change Order

17.8.1 The following format shall be used as applicable by the District and the Contractor (e.g. Change Orders, PCO’s) to communicate proposed additions and deductions to the Contract, supported by attached documentation. Any spaces left blank will be deemed no change to cost or time.

	<u>WORK PERFORMED OTHER THAN BY CONTRACTOR</u>	<u>ADD</u>	<u>DEDUCT</u>
(a)	Material (attach suppliers’ invoice or itemized quantity and unit cost plus sales tax)		
(b)	Add Labor (attach itemized hours and rates, fully Burdened, and specify the hourly rate for each additional labor burden, for example, payroll taxes, fringe benefits, etc.)		
(c)	Add Equipment (attach suppliers’ invoice)		
(d)	Subtotal		
(e)	Add Overhead and Profit for any and all tiers of Subcontractor , the total not to exceed ten percent (10%) of Item (d)		
(f)	Subtotal		
(g)	Add General Conditions Cost (if Time is Compensable) (attach supporting documentation)		
(h)	Subtotal		
(i)	Add Overhead and Profit for Contractor , not to exceed five percent (5%) of Item (h)		
(j)	Subtotal		
(k)	Add Bond and Insurance , not to exceed two percent (2%) of Item (j) Only if PCO exceeds the Allowance		
(l)	TOTAL		
(m)	Time (zero unless indicated; “TBD” not permitted)	_____ Calendar Days	

	<u>WORK PERFORMED BY CONTRACTOR</u>	<u>ADD</u>	<u>DEDUCT</u>
(n)	Material (attach itemized quantity and unit cost plus sales tax)		
(o)	Add Labor (attach itemized hours and rates, fully Burdened, and specify the hourly rate for each additional labor burden, for example, payroll taxes, fringe benefits, etc.)		
(p)	Add Equipment (attach suppliers’ invoice)		
(q)	Add General Conditions Cost (if Time is Compensable) (attach supporting documentation)		
(r)	Subtotal		
(s)	Add Overhead and Profit for Contractor , not to exceed fifteen percent (15%) of Item (e)		
(t)	Subtotal		
(u)	Add Bond and Insurance , not to exceed two percent (2%) of Item (g) Only if PCO exceeds the Allowance		
(v)	TOTAL		
(w)	Time (zero unless indicated; “TBD” not permitted)	_____ Calendar Days	

17.8.2 Labor.

Contractor shall be compensated for the costs of labor actually and directly utilized in the performance of the Work. Such labor costs shall be the actual cost, use of any formulas (e.g. labor factors) is not allowed, not to exceed prevailing wage rates in the locality of the Site and shall be in the labor classification(s) necessary for the performance of the Work, fully Burdened. Labor costs shall exclude costs incurred by the Contractor in preparing estimate(s) of the costs of the change in the Work, in the maintenance of records relating to the costs of the change in the Work, coordination and assembly of materials and information relating to the change in the Work or performance thereof, or the supervision and other overhead and general conditions costs associated with the change in the Work or performance thereof, including but not limited to the cost for the job superintendent. If applicable, District will pay Contractor the reasonable costs for room and board, supported with appropriate backup documentation, without markup for profit or overhead as provided by U.S. General Services Administration per diem rates for California lodging, meals and incidentals, <https://www.gsa.gov/travel/plan-book/per-diem-rates/per-diem-rates-lookup>.

17.8.3 Materials.

Contractor shall be compensated for the costs of materials necessarily and actually used or consumed in connection with the performance of the change in the Work. Costs of materials may include reasonable costs of transportation from a source closest to the Site of the Work and delivery to the Site. If discounts by material suppliers are available for materials necessarily used in the performance of the change in the Work, they shall be credited to the District. If materials necessarily used in the performance of the change in the Work are obtained from a supplier or source owned in whole or in part by the Contractor, compensation therefor shall not exceed the current wholesale price for such materials. If, in the reasonable opinion of the District, the costs asserted by the Contractor for materials in connection with any change in the Work are excessive, or if the Contractor fails to provide satisfactory evidence of the actual costs of such materials from its supplier or vendor of the same, the costs of such materials and the District's obligation to pay for the same shall be limited to the then lowest wholesale price at which similar materials are available in the quantities required to perform the change in the Work. The District may elect to furnish materials for the change in the Work, in which event the Contractor shall not be compensated for the costs of furnishing such materials or any mark-up thereon.

17.8.4 Equipment.

As a precondition to the District's duty to pay for Equipment rental or loading and transportation, Contractor shall provide satisfactory evidence of the actual costs of Equipment from the supplier, vendor or rental agency of same. Contractor shall be compensated for the actual cost of the necessary and direct use of Equipment in the performance of the change in the Work. Use of such Equipment in the performance of the change in the Work shall be compensated in increments of fifteen (15) minutes. Rental time for Equipment moved by its own power shall include time required to move such Equipment to the site of the Work from the nearest available rental source of the same. If Equipment is not moved to the Site by its own power, Contractor will be compensated for the loading and transportation costs in lieu of

rental time. The foregoing notwithstanding, neither moving time or loading and transportation time shall be allowed if the Equipment is used for performance of any portion of the Work other than the change in the Work. Unless prior approval in writing is obtained by the Contractor from the Architect, the Project Inspector and the District, no costs or compensation shall be allowed for time while Construction Equipment is inoperative, idle or on standby, for any reason. Contractor shall not be entitled to an allowance or any other compensation for Equipment or tools used in the performance of change in the Work where such Equipment or tools have a replacement value of \$500.00 or less. Equipment costs claimed by the Contractor in connection with the performance of any Work shall not exceed rental rates established by distributors or construction equipment rental agencies in the locality of the Site; any costs asserted which exceed such rental rates shall not be allowed or paid. Unless otherwise specifically approved in writing by the Architect, the Project Inspector and the District, the allowable rate for the use of Equipment in connection with the Work shall constitute full compensation to the Contractor for the cost of rental, fuel, power, oil, lubrication, supplies, necessary attachments, repairs or maintenance of any kind, depreciation, storage, insurance, labor (exclusive of labor costs of the Equipment operator), and any and all other costs incurred by the Contractor incidental to the use of such Equipment.

17.8.5 General Conditions Cost.

The phrase "General Conditions Cost" shall mean, other than expressly limited or excluded herein, the costs of Contractor during the construction phase, including but not limited to: payroll costs for project manager for Work conducted at the Site, payroll costs for the superintendent and full-time general foremen, workers not included as direct labor costs engaged in support functions (e.g., loading/unloading, clean-up), costs of offices and temporary facilities including office materials, office supplies, office equipment, minor expenses, utilities, fuel, sanitary facilities and telephone services at the Site, costs of consultants not in the direct employ of Contractor or Subcontractors, and fees for permits and licenses.

17.8.6 Overhead and Profit.

The phrase "Overhead and Profit" shall include field and office supervisors and assistants, watchperson, use of small tools, consumable, insurance other than construction bonds and insurance required herein, general conditions costs and home office expenses.

17.9 Change Order Certification

17.9.1 All Change Orders and PCOs include the following certification by the Contractor, either in the form specifically or incorporated by this reference:

17.9.1.1 The undersigned Contractor approves the foregoing as to the changes, if any, to the Contract Price specified for each item, and as to the extension of time allowed, if any, for completion of the entire Work as stated herein, and agrees to furnish all labor, materials, and service, and perform all work necessary to complete any additional work specified for the consideration stated herein. Submission of sums which have no basis in fact or which Contractor knows are false are at the sole risk of Contractor and may be a violation of the False Claims Act set forth under Government Code section 12650 et seq. It is understood that

the changes herein to the Contract shall only be effective when approved by the governing board of the District.

17.9.1.2 It is expressly understood that the value of the extra Work or changes expressly includes any and all of the Contractor's costs and expenses, direct and indirect, resulting from additional time required on the Project or resulting from delay to the Project including, without limitation, cumulative impacts. Contractor is not entitled to separately recover amounts for overhead or other indirect costs. Any costs, expenses, damages, or time extensions not included are deemed waived.

17.9.2 Accord and Satisfaction: Contractor's execution of any Change Order shall constitute a full accord and satisfaction, and release, of all Contractor (and if applicable, Subcontractor) claims for additional time, money or other relief arising from or relating to the subject matter of the change including, without limitation, impacts of all types, cumulative impacts, inefficiency, overtime, delay and any other type of claim.

17.10 Determination of Change Order Cost

17.10.1 The amount of the increase or decrease in the Contract Price from a Change Order, if any, shall be determined in one or more of the following ways as applicable to a specific situation and at the District's discretion:

17.10.1.1 District acceptance of a PCO;

17.10.1.2 By unit prices contained in Contractor's original bid;

17.10.1.3 By agreement between District and Contractor.

17.11 Deductive Change Orders

All deductive Change Order(s) must be prepared pursuant to the provisions herein. Where a portion of the Work is deleted from the Contract, the reasonable value of the deducted work less the value of work performed shall be considered the appropriate deduction. The value submitted on the Schedule of Values shall be used to calculate the credit amount unless the bid documentation is being held in escrow as part of the Contract Documents. Unit Prices, if any, may be used in District's discretion in calculating reasonable value. If Contractor offers a proposed amount for a deductive Change Order(s), Contractor shall include a minimum of five percent (5%) total profit and overhead to be deducted with the amount of the work of the Change Order(s). If Subcontractor work is involved, Subcontractors shall also include a minimum of five percent (5%) profit and overhead to be deducted with the amount of its deducted work. Any deviation from this provision shall not be allowed.

17.12 Addition or Deletion of Alternate Bid Item(s)

If the Bid Form and Proposal includes proposal(s) for Alternate Bid Item(s), during Contractor's performance of the Work, the District may elect to add or delete any such Alternate Bid Item(s) if not included in the Contract at the time of award. If the District elects to add or delete Alternate Bid Item(s) after Contract award, the cost or credit for such Alternate Bid Item(s) shall be as set forth in the Bid Form and Proposal unless the

parties agree to a different price and the Contract Time shall be adjusted by the number of days allocated in the Contract Documents. If days are not allocated in the Contract Documents, the Contract Time shall be equitably adjusted.

17.13 Discounts, Rebates, and Refunds

For purposes of determining the cost, if any, of any change, addition, or omission to the Work hereunder, all trade discounts, rebates, refunds, and all returns from the sale of surplus materials and equipment shall accrue and be credited to the Contractor, and the Contractor shall make provisions so that such discounts, rebates, refunds, and returns may be secured, and the amount thereof shall be allowed as a reduction of the Contractor's cost in determining the actual cost of construction for purposes of any change, addition, or omission in the Work as provided herein.

17.14 Accounting Records

With respect to portions of the Work performed by Change Orders and Construction Change Directives, the Contractor shall keep and maintain cost-accounting records satisfactory to the District, including, without limitation, Job Cost Reports as provided in these General Conditions, which shall be available to the District on the same terms as any other books and records the Contractor is required to maintain under the Contract Documents. Such records shall include without limitation hourly records for Labor and Equipment and itemized records of materials and Equipment used that day in connection with the performance of any Work. All records maintained hereunder shall be subject to inspection, review and/or reproduction by the District, the Architect or the Project Inspector upon request. In the event that the Contractor fails or refuses, for any reason, to maintain or make available for inspection, review and/or reproduction such records, the District's reasonable good faith determination of the extent of adjustment to the Contract Price shall be final, conclusive, dispositive and binding upon Contractor.

17.15 Notice Required

If the Contractor desires to make a claim for an increase in the Contract Price, or any extension in the Contract Time for completion, it shall notify the District pursuant to the provisions herein, including the Article on Claims and Disputes. No claim shall be considered unless made in accordance with this subparagraph. Contractor shall proceed to execute the Work even though the adjustment may not have been agreed upon. Any change in the Contract Price or extension of the Contract Time resulting from such claim shall be authorized by a Change Order.

17.16 Applicability to Subcontractors

Any requirements under this Article shall be equally applicable to Change Orders or Construction Change Directives issued to Subcontractors by the Contractor to the extent as required by the Contract Documents.

17.17 Alteration to Change Order Language

Contractor shall not alter Change Orders or reserve time in Change Orders. Change Orders altered in violation of this provision, if in conflict with the terms set forth herein, shall be construed in accordance with the terms set forth herein. Contractor shall

execute finalized Change Orders and proceed under the provisions herein with proper notice.

17.18 Failure of Contractor to Execute Change Order

Contractor shall be in default of the Contract if Contractor fails to execute a Change Order when the Contractor agrees with the addition and/or deletion of the Work in that Change Order.

18. REQUEST FOR INFORMATION

18.1 Any Request for Information shall reference all applicable Contract Document(s), including Specification section(s), detail(s), page number(s), drawing number(s), and sheet number(s), etc. The Contractor shall make suggestions and interpretations of the issue raised by each Request for Information. A Request for Information cannot modify the Contract Price, Contract Time, or the Contract Documents. Upon request by the District, Contractor shall provide an electronic copy of the Request for Information in addition to the hard copy.

18.2 The Contractor shall be responsible for any costs incurred for professional services that District may deduct from any amounts owing to the Contractor, if a Request for Information requests an interpretation or decision of a matter where the information sought is equally available to the party making the request. District, at its sole discretion, shall deduct from and/or invoice Contractor for all the professional services arising herein.

19. PAYMENTS

19.1 Contract Price

The Contract Price is stated in the Agreement and, including authorized adjustments, is the total amount payable by the District to the Contractor for performance of the Work under the Contract Documents.

19.2 Applications for Progress Payments

19.2.1 Procedure for Applications for Progress Payments

19.2.1.1 Application for Progress Payment

19.2.1.1.1 Not before the fifth (5th) day of each calendar month during the progress of the Work, Contractor shall submit to the District and the Architect an itemized Application for Payment for operations completed in accordance with the Schedule of Values. Such application shall be notarized, if required, and supported by the following or each portion thereof unless waived by the District in writing:

19.2.1.1.1.1 The amount paid to the date of the Application to the Contractor, to all its Subcontractors, and all others furnishing labor, material, or equipment for its Contract;

19.2.1.1.1.2 The amount being requested under the Application for Payment by the Contractor on its own behalf and separately stating the amount requested on behalf of each of the Subcontractors and all others furnishing labor, material, and equipment under the Contract;

19.2.1.1.1.3 The balance that will be due to each of such entities after said payment is made;

19.2.1.1.1.4 A certification that the As-Built Drawings and annotated Specifications are current;

19.2.1.1.1.5 Itemized breakdown of work done for the purpose of requesting partial payment;

19.2.1.1.1.6 An updated and acceptable construction schedule in conformance with the provisions herein;

19.2.1.1.1.7 The additions to and subtractions from the Contract Price and Contract Time;

19.2.1.1.1.8 A total of the retentions held;

19.2.1.1.1.9 Material invoices, evidence of equipment purchases, rentals, and other support and details of cost as the District may require from time to time;

19.2.1.1.1.10 The percentage of completion of the Contractor's Work by line item;

19.2.1.1.1.11 Schedule of Values updated from the preceding Application for Payment;

19.2.1.1.1.12 A duly completed and executed conditional waiver and release upon progress payment compliant with Civil Code section 8132 from the Contractor and each subcontractor of any tier and supplier to be paid from the current progress payment;

19.2.1.1.1.13 A duly completed and executed unconditional waiver and release upon progress payment compliant with Civil Code section 8134 from the Contractor and each subcontractor of any tier and supplier that was paid from the previous progress payment(s); and

19.2.1.1.1.14 A certification by the Contractor of the following:

The Contractor warrants title to all Work performed as of the date of this payment application has been completed in accordance with the Contract Documents for the Project. The Contractor further warrants that all amounts have been paid for work which previous Certificates for Payment were issued and payments received and all Work performed as of the date of this payment application is free and clear of liens, claims, security interests, or encumbrances in favor of the Contractor, Subcontractors, material and equipment suppliers, workers, or other persons or entities making a claim by reason of having provided labor, materials, and equipment relating to the Work, except those of which the District has been informed. Submission of sums which have no basis in fact or which Contractor knows are false are at the sole risk of Contractor and may be a violation of the False Claims Act set forth under Government Code section 12650 et seq.

19.2.1.1.1.15 The Contractor shall be subject to the False Claims Act set forth in Government Code section 12650 et seq. for information provided with any Application for Progress Payment.

19.2.1.1.1.16 All remaining certified payroll records ("CPR(s)") for each journeyman, apprentice, worker, or other employee employed by the Contractor and/or each Subcontractor in connection with the Work for the period of the Application for Payment. As indicated herein, the District shall not make any payment to Contractor until:

19.2.1.1.1.16.1 Contractor and/or its Subcontractor(s) provide electronic CPRs directly to the DIR on no less than every 30 days while Work is being performed and within 30 days after the final day of Work performed on the Project for any journeyman, apprentice, worker or other employee was employed in connection with the Work, or within ten (10) days of any request by the District or the DIR to the requesting entity, and

19.2.1.1.1.16.2 Any delay in Contractor and/or its Subcontractor(s) providing CPRs in a timely manner may directly delay the Contractor's payment.

19.2.1.1.2 Applications received after June 20th will not be paid until the second week of July and applications received after December 12th will not be paid until the first week of January.

19.2.2 Prerequisites for Progress Payments

19.2.2.1 First Payment Request: The following items, if applicable, must be completed before the District will accept and/or process the Contractor's first payment request:

19.2.2.1.1 Installation of the Project sign;

19.2.2.1.2 Installation of field office;

- 19.2.2.1.3** Installation of temporary facilities and fencing;
- 19.2.2.1.4** Schedule of Values;
- 19.2.2.1.5** Contractor's Construction Schedule;
- 19.2.2.1.6** Schedule of unit prices, if applicable;
- 19.2.2.1.7** Submittal Schedule;
- 19.2.2.1.8** Receipt by Architect of all submittals due as of the date of the payment application;
- 19.2.2.1.9** Copies of necessary permits;
- 19.2.2.1.10** Copies of authorizations and licenses from governing authorities;
- 19.2.2.1.11** Initial progress report;
- 19.2.2.1.12** Surveyor qualifications;
- 19.2.2.1.13** Written acceptance of District's survey of rough grading, if applicable;
- 19.2.2.1.14** List of all Subcontractors, with names, license numbers, telephone numbers, and Scope of Work;
- 19.2.2.1.15** All bonds and insurance endorsements; and
- 19.2.2.1.16** Resumes of Contractor's project manager, and if applicable, job site secretary, record documents recorder, and job site superintendent.

19.2.2.2 Second Payment Request:

The District will not process the second payment request until and unless all submittals and Shop Drawings have been accepted for review by the Architect.

19.2.2.3 No Waiver of Criteria:

Any payments made to Contractor where criteria set forth herein have not been met shall not constitute a waiver of said criteria by District. Instead, such payment shall be construed as a good faith effort by District to resolve differences so Contractor may pay its Subcontractors and suppliers. Contractor agrees that failure to submit such items may constitute a breach of contract by Contractor and may subject Contractor to termination.

19.3 Progress Payments

19.3.1 District's Approval of Application for Payment

19.3.1.1 Upon receipt of an Application for Payment, The District shall act in accordance with both of the following:

19.3.1.1.1 Each Application for Payment shall be reviewed by the District as soon as practicable after receipt for the purpose of determining that the Application for Payment is a proper Application for Payment.

19.3.1.1.2 Any Application for Payment determined not to be a proper Application for Payment suitable for payment shall be returned to the Contractor as soon as practicable, but not later than seven (7) days, after receipt. An Application for Payment returned pursuant to this paragraph shall be accompanied by a document setting forth in writing the reasons why the Application for Payment is not proper. The number of days available to the District to make a payment without incurring interest pursuant to this section shall be reduced by the number of days by which the District exceeds this seven-day return requirement.

19.3.1.1.3 An Application for Payment shall be considered properly executed if funds are available for payment of the Application for Payment, and payment is not delayed due to an audit inquiry by the financial officer of the District.

19.3.1.2 The District's review of the Contractor's Application for Payment will be based on the District's and the Architect's observations at the Site and the data comprising the Application for Payment that the Work has progressed to the point indicated and that, to the best of the District's and the Architect's knowledge, information, and belief, the quality of the Work is in accordance with the Contract Documents. The foregoing representations are subject to:

19.3.1.2.1 Observation of the Work for general conformance with the Contract Documents,

19.3.1.2.2 Results of subsequent tests and inspections,

19.3.1.2.3 Minor deviations from the Contract Documents correctable prior to completion, and

19.3.1.2.4 Specific qualifications expressed by the Architect.

19.3.1.3 District's approval of the certified Application for Payment shall be based on Contractor complying with all requirements for a fully complete and valid certified Application for Payment.

19.3.2 Payments to Contractor

19.3.2.1 Within thirty (30) days after approval of the Application for Payment, Contractor shall be paid a sum equal to ninety-five percent (95%) of the value of the Work performed (as verified by Architect and Inspector and certified by Contractor) up to the last day of the previous month, less the aggregate of previous payments and amount to be withheld. The value of the Work completed shall be Contractor's best estimate. No inaccuracy or error in said estimate shall operate to release the Contractor, or any Surety upon any bond, from damages

arising from such Work, or from the District's right to enforce each and every provision of this Contract, and the District shall have the right subsequently to correct any error made in any estimate for payment.

19.3.2.2 The Contractor shall not be entitled to have any payment requests processed, or be entitled to have any payment made for Work performed, so long as any lawful or proper direction given by the District concerning the Work, or any portion thereof, remains incomplete.

19.3.2.3 If the District fails to make any progress payment within thirty (30) days after receipt of an undisputed and properly submitted Application for Payment from the Contractor, the District shall pay interest to the Contractor equivalent to the legal rate set forth in subdivision (a) of Section 685.010 of the Code of Civil Procedure.

19.3.3 No Waiver

No payment by District hereunder shall be interpreted so as to imply that District has inspected, approved, or accepted any part of the Work. Notwithstanding any payment, the District may enforce each and every provision of this Contract. The District may correct or require correction of any error subsequent to any payment.

19.4 Decisions to Withhold Payment

19.4.1 Reasons to Withhold Payment

The District may withhold payment in whole, or in part, to the extent reasonably necessary to protect the District if, in the District's opinion, the representations to the District required herein cannot be made. The District may withhold payment, in whole, or in part, to such extent as may be necessary to protect the District from loss because of, but not limited to any of the following:

19.4.1.1 Defective Work not remedied within **FORTY-EIGHT (48)** hours of written notice to Contractor.

19.4.1.2 Stop Payment Notices or other liens served upon the District as a result of the Contract. Contractor agrees that the District may withhold up to 125% of the amount claimed in the Stop Payment Notice to answer the claim and to provide for the District's reasonable cost of any litigation pursuant to the stop payment notice.

19.4.1.3 Written notice to withhold payment from Contractor by payment and/or performance bond surety(ies).

19.4.1.4 Liquidated damages assessed against the Contractor.

19.4.1.5 The cost of completion of the Contract if there exists a reasonable doubt that the Work can be completed for the unpaid balance of the Contract Price or by the completion date.

19.4.1.6 Damage to the District or other contractor(s).

19.4.1.7 Unsatisfactory prosecution of the Work by the Contractor.

19.4.1.8 Failure to store and properly secure materials.

19.4.1.9 Failure of the Contractor to submit, on a timely basis, proper, sufficient, and acceptable documentation required by the Contract Documents, including, without limitation, a Construction Schedule, Schedule of Submittals, Schedule of Values, Monthly Progress Schedules, Shop Drawings, Product Data and samples, Proposed product lists, executed Change Orders, and/or verified reports.

19.4.1.10 Failure of the Contractor to maintain As-Built Drawings.

19.4.1.11 Erroneous estimates by the Contractor of the value of the Work performed, or other false statements in an Application for Payment.

19.4.1.12 Unauthorized deviations from the Contract Documents.

19.4.1.13 Failure of the Contractor to prosecute the Work in a timely manner in compliance with the Construction Schedule, established progress schedules, and/or completion dates.

19.4.1.14 Failure to provide acceptable electronic certified payroll records, as required by the Labor Code, by these Contract Documents, or by written request; for each journeyman, apprentice, worker, or other employee employed by the Contractor and/or by each Subcontractor in connection with the Work for the period of the Application for Payment or if payroll records are delinquent or inadequate.

19.4.1.15 Failure to properly pay prevailing wages as required in Labor Code section 1720 et seq., failure to comply with any other Labor Code requirements, and/or failure to comply with labor compliance monitoring and enforcement by the DIR.

19.4.1.16 Allowing an unregistered subcontractor, as described in Labor Code section 1725.5, to engage in the performance of any work under this Contract.

19.4.1.17 Failure to comply with any applicable federal statutes and regulations regarding minimum wages, withholding, payrolls and basic records, apprentice and trainee employment requirements, equal employment opportunity requirements, Copeland Act requirements, Davis-Bacon Act and related requirements, Contract Work Hours and Safety Standards Act requirements, if applicable.

19.4.1.18 Failure to properly maintain or clean up the Site.

19.4.1.19 Failure to timely indemnify, defend, or hold harmless the District.

19.4.1.20 Any payments due to the District, including but not limited to payments for failed tests, utilities changes, or permits.

19.4.1.21 Failure to pay Subcontractor(s) or supplier(s) as required by law and by the Contract Documents.

19.4.1.22 Failure to pay any royalty, license or similar fees.

19.4.1.23 Contractor is otherwise in breach, default, or in substantial violation of any provision of this Contract.

19.4.1.24 Failure to perform any implementation and/or monitoring required by any SWPPP for the Project and/or the imposition of any penalties or fines therefore whether imposed on the District or Contractor.

19.4.2 Reallocation of Withheld Amounts

19.4.2.1 District may, in its discretion, apply any withheld amount to pay outstanding claims or obligations as defined herein. In so doing, District shall make such payments on behalf of Contractor. If any payment is so made by District, then that amount shall be considered a payment made under Contract by District to Contractor and District shall not be liable to Contractor for any payment made in good faith. These payments may be made without prior judicial determination of claim or obligation. District will render Contractor an accounting of funds disbursed on behalf of Contractor.

19.4.2.2 If Contractor defaults or neglects to carry out the Work in accordance with the Contract Documents or fails to perform any provision thereof, District may, after **FORTY-EIGHT (48)** hours' written notice to the Contractor and, without prejudice to any other remedy, make good such deficiencies. The District shall adjust the total Contract Price by reducing the amount thereof by the cost of making good such deficiencies. If District deems it inexpedient to correct Work that is damaged, defective, or not done in accordance with Contract provisions, an equitable reduction in the Contract Price (of at least one hundred fifty percent (150%) of the estimated reasonable value of the nonconforming Work) shall be made therefor.

19.4.3 Payment After Cure

When Contractor removes the grounds for declining approval, payment shall be made for amounts withheld because of them. No interest shall be paid on any retainage or amounts withheld due to the failure of the Contractor to perform in accordance with the terms and conditions of the Contract Documents.

19.5 Subcontractor Payments

19.5.1 Payments to Subcontractors

No later than seven (7) days after receipt, or pursuant to Business and Professions Code section 7108.5 and Public Contract Code section 7107, the Contractor shall pay to each Subcontractor, out of the amount paid to the Contractor on account of such Subcontractor's portion of the Work, the amount to which said Subcontractor is entitled. The Contractor shall, by appropriate agreement with each Subcontractor, require each Subcontractor to make payments to its Sub-subcontractors in a similar manner.

19.5.2 No Obligation of District for Subcontractor Payment

The District shall have no obligation to pay, or to see to the payment of, money to a Subcontractor except as may otherwise be required by law.

19.5.3 Joint Checks

District shall have the right in its sole discretion, if necessary for the protection of the District, to issue joint checks made payable to the Contractor and Subcontractors and/or material or equipment suppliers. The joint check payees shall be responsible for the allocation and disbursement of funds included as part of any such joint payment. In no event shall any joint check payment be construed to create any contract between the District and a Subcontractor of any tier, or a material or equipment supplier, any obligation from the District to such Subcontractor or a material or equipment supplier, or rights in such Subcontractor or a material or equipment supplier against the District.

20. COMPLETION OF THE WORK

20.1 Completion

20.1.1 District will accept completion of Contract and have the Notice of Completion recorded when the entire Work shall have been completed to the satisfaction of District.

20.1.2 The Work may only be accepted as complete by action of the governing board of the District.

20.1.3 District, at its sole option, may accept completion of Contract and have the Notice of Completion recorded when the entire Work shall have been completed to the satisfaction of District, except for minor corrective items, as distinguished from incomplete items. If Contractor fails to complete all minor corrective items within fifteen (15) days after the date of the District's acceptance of completion, District shall withhold from the final payment one hundred fifty percent (150%) of an estimate of the amount sufficient to complete the corrective items, as determined by District, until the item(s) are completed.

20.1.4 At the end of the 15-day period, if there are any items remaining to be corrected, District may elect to proceed as provided herein related to adjustments to Contract Price, and/or District's right to perform the Work of the Contractor.

20.2 Close-Out/Certification Procedures

20.2.1 Punch List

The Contractor shall notify the Architect when Contractor considers the Work complete. Upon notification, Architect will prepare a list of minor items to be completed or corrected ("Punch List"). The Contractor and/or its Subcontractors shall proceed promptly to complete and correct items on the Punch List. Failure to include an item on Punch List does not alter the responsibility of the Contractor to complete all Work in accordance with the Contract Documents.

20.2.2 Close-Out/Certification Requirements

20.2.2.1 Utility Connections

Buildings shall be connected to water, gas, sewer, and electric services, complete and ready for use. Service connections shall be made and existing services reconnected.

20.2.2.2 Record Drawings and Record Specifications

20.2.2.2.1 Contractor shall provide exact Record Drawings of the Work ("As-BUILTS") and Record Specifications upon completion of the Project and as a condition precedent to approval of final payment.

20.2.2.2.2 Contractor shall obtain the Inspector's approval of the corrected prints and employ a competent draftsman to transfer the Record Drawings information to the most current version of AutoCAD that is, at that time, currently utilized for plan check submission by either the District, the Architect, OPSC, and/or DSA, and print a complete set of transparent sepias. When completed, Contractor shall deliver corrected sepias and diskette/CD/other data storage device acceptable to District with AutoCAD file to the District.

20.2.2.2.3 Contractor is liable and responsible for any and all inaccuracies in the Record Drawings and Record Specifications, even if inaccuracies become evident at a future date.

20.2.2.3 Construction Storm Water Permit, if applicable

Contractor shall submit to District all electronic or hard copy records required by the Construction Storm Water Permit, if applicable, within seven (7) days of Completion of the Project.

20.2.2.4 Maintenance Manuals: Contractor shall prepare all operation and maintenance manuals and date as indicated in the Specifications.

20.2.2.5 Source Programming: Contractor shall provide all source programming for all items in the Project.

20.2.2.6 Verified Reports: Contractor shall completely and accurately fill out and file forms DSA 6-C or DSA 152 (or current form), as appropriate. Refer to section 4-336 and section 4-343 of Part 1, Title 24 of the California Code of Regulations.

20.3 Final Inspection

20.3.1 Contractor shall comply with Punch List procedures as provided herein, and maintain the presence of a Project Superintendent and Project Manager until the Punch List is complete to ensure proper and timely completion of the Punch List. Under no circumstances shall Contractor demobilize its forces prior to completion of the Punch List without District's prior written approval. Upon receipt of Contractor's written notice that all of the Punch List items have been fully completed and the

Work is ready for final inspection and District acceptance, Architect and Project Inspector will inspect the Work and shall submit to Contractor and District a final inspection report noting the Work, if any, required in order to complete in accordance with the Contract Documents. Absent unusual circumstances, this report shall consist of the Punch List items not yet satisfactorily completed.

20.3.2 Upon Contractor's completion of all items on the Punch List and any other uncompleted portions of the Work, the Contractor shall notify the District and Architect, who shall again inspect such Work. If the Architect finds the Work complete and acceptable under the Contract Documents, the Architect will notify Contractor, who shall then jointly submit to the Architect and the District its final Application for Payment.

20.3.3 Final Inspection Requirements

20.3.3.1 Before calling for final inspection, Contractor shall determine that the following have been performed:

20.3.3.1.1 The Work has been completed.

20.3.3.1.2 All life safety items are completed and in working order.

20.3.3.1.3 Mechanical and electrical Work including, without limitation, security system, data, and fire alarm, are complete and tested, fixtures are in place, connected, and ready for tryout.

20.3.3.1.4 Electrical circuits scheduled in panels and disconnect switches labeled.

20.3.3.1.5 Painting and special finishes complete.

20.3.3.1.6 Doors complete with hardware, cleaned of protective film, relieved of sticking or binding, and in working order.

20.3.3.1.7 Tops and bottoms of doors sealed.

20.3.3.1.8 Floors waxed and polished as specified.

20.3.3.1.9 Broken glass replaced and glass cleaned.

20.3.3.1.10 Grounds cleared of Contractor's equipment, raked clean of debris, and trash removed from Site.

20.3.3.1.11 Work cleaned, free of stains, scratches, and other foreign matter, and damaged and broken material replaced.

20.3.3.1.12 Finished and decorative work shall have marks, dirt, and superfluous labels removed.

20.3.3.1.13 Final cleanup, as provided herein.

20.4 Costs of Multiple Inspections

More than two (2) requests of the District to make a final inspection shall be considered an additional service of District, Architect, Construction Manager, and/or Project Inspector, and all subsequent costs will be invoiced to Contractor and if funds are available, withheld from remaining payments.

20.5 Partial Occupancy or Use Prior to Completion

20.5.1 District's Rights to Occupancy

The District may occupy or use any completed or partially completed portion of the Work at any stage, and such occupancy shall not constitute the District's Final Acceptance of any part of the Work. Neither the District's Final Acceptance, the making of Final Payment, any provision in Contract Documents, nor the use or occupancy of the Work, in whole or in part, by District shall constitute acceptance of Work not in accordance with the Contract Documents nor relieve the Contractor or the Contractor's Performance Bond Surety from liability with respect to any warranties or responsibility for faulty or defective Work or materials, equipment and workmanship incorporated therein. In the event that the District occupies or uses any completed or partially completed portion of the Work, the Contractor shall remain responsible for payments, security, maintenance, heat, utilities, damage to the Work, insurance, the period for correction of the Work, and the commencement of warranties required by the Contract Documents unless the Contractor requests in writing, and the District agrees, to otherwise divide those responsibilities. Any dispute as to responsibilities shall be resolved pursuant to the Claims and Disputes provisions herein, with the added provision that during the dispute process, the District shall have the right to occupy or use any portion of the Work that it needs or desires to use.

20.5.2 Inspection Prior to Occupancy or Use

Immediately prior to partial occupancy or use, the District, the Contractor, and the Architect shall jointly inspect the area to be occupied or portion of the Work to be used in order to determine and record the condition of the Work.

20.5.3 No Waiver

Unless otherwise agreed upon, partial or entire occupancy or use of a portion or portions of the Work shall not constitute beneficial occupancy or District's acceptance of the Work not complying with the requirements of the Contract Documents.

21. FINAL PAYMENT AND RETENTION

21.1 Final Payment

Upon receipt and approval of a valid and final Application for Payment, the Architect will issue a final Certificate of Payment. The District shall thereupon jointly inspect the Work and either accept the Work as complete or notify the Architect and the Contractor in writing of reasons why the Work is not complete. Upon District's acceptance of the Work of the Contractor as fully complete by the Governing Board of the District (that, absent unusual circumstances, will occur when the Punch List items have been satisfactorily

completed), the District shall record a Notice of Completion with the County Recorder, and the Contractor shall, upon receipt of final payment from the District, pay the amount due Subcontractors.

21.2 Prerequisites for Final Payment

The following conditions must be fulfilled prior to Final Payment:

21.2.1 A full release of all Stop Payment Notices served in connection with the Work shall be submitted by Contractor.

21.2.2 A duly completed and executed conditional waiver and release upon final payment compliant with Civil Code section 8136, from the Contractor and each subcontractor of any tier and supplier to be paid from the final payment.

21.2.3 A duly completed and executed unconditional waiver and release upon progress payment compliant with Civil Code section 8134, from the Contractor and each subcontractor of any tier and supplier that was paid from the previous progress payments.

21.2.4 A duly completed and executed Document 00 65 19.26, "AGREEMENT AND RELEASE OF ANY AND ALL CLAIMS" from the Contractor.

21.2.5 The Contractor shall have made all corrections to the Work that are required to remedy any defects therein, to obtain compliance with the Contract Documents or any requirements of applicable codes and ordinances, or to fulfill any of the orders or directions of District required under the Contract Documents.

21.2.6 Each Subcontractor shall have delivered to the Contractor all written guarantees, warranties, applications, and bonds required by the Contract Documents for its portion of the Work.

21.2.7 Contractor must have completed all requirements set forth under "Close-Out/Certification Procedures," including, without limitation, submission of an approved set of complete Record Drawings.

21.2.8 Architect shall have issued its written approval that final payment can be made.

21.2.9 The Contractor shall have delivered to the District all manuals and materials required by the Contract Documents, which must be approved by the District.

21.2.10 The Contractor shall have completed final clean-up as provided herein.

21.3 Retention

21.3.1 The retention, less any amounts disputed by the District or that the District has the right to withhold pursuant to provisions herein, shall be paid:

21.3.1.1 After approval by the Architect of the Application and Certificate of Payment,

21.3.1.2 After the satisfaction of the conditions set forth herein, and

21.3.1.3 After forty-five (45) days after the recording of the Notice of Completion by District.

21.3.2 No interest shall be paid on any retention, or on any amounts withheld due to a failure of the Contractor to perform, in accordance with the terms and conditions of the Contract Documents, except as provided to the contrary in any Escrow Agreement between the District and the Contractor pursuant to Public Contract Code section 22300.

21.4 Substitution of Securities

The District will permit the substitution of securities in accordance with the provisions of Public Contract Code section 22300.

22. UNCOVERING OF WORK

If a portion of the Work is covered without Inspector or Architect approval or not in compliance with the Contract Documents, it must, if required in writing by the District, the Project Inspector, or the Architect, be uncovered for the Project Inspector's or the Architect's observation and be corrected, replaced, and/or recovered at the Contractor's expense without change in the Contract Price or Contract Time.

23. NONCONFORMING WORK AND CORRECTION OF WORK

23.1 Nonconforming Work

23.1.1 Contractor shall promptly remove from Premises all Work identified by District as failing to conform to the Contract Documents whether incorporated or not. Contractor shall promptly replace and re-execute its own Work to comply with the Contract Documents without additional expense to the District and shall bear the expense of making good all work of other contractors destroyed or damaged by any removal or replacement pursuant hereto and/or any delays to the District or other Contractors caused thereby.

23.1.2 If Contractor does not remove Work that District has identified as failing to conform to the Contract Documents within a reasonable time, not to exceed **FORTY-EIGHT (48)** hours, District may remove it and may store any material at Contractor's expense. If Contractor does not pay expense(s) of that removal within ten (10) days' time thereafter, District may, upon ten (10) days' written notice, sell any material at auction or at private sale and shall deduct all costs and expenses incurred by the District and/or District may withhold those amounts from payment(s) to Contractor.

23.2 Correction of Work

23.2.1 Correction of Rejected Work

Pursuant to the notice provisions herein, the Contractor shall immediately correct the Work rejected by the District, the Architect, or the Project Inspector as failing to conform to the requirements of the Contract Documents, whether observed before or

after Completion and whether or not fabricated, installed, or completed. The Contractor shall bear costs of correcting the rejected Work, including additional testing, inspections, and compensation for the Inspector's or the Architect's services and expenses made necessary thereby.

23.2.2 Two-Year Warranty Corrections

If, within two (2) years after the date of Completion of the Work or a designated portion thereof, or after the date for commencement of warranties established hereunder, or by the terms of an applicable special warranty required by the Contract Documents, any of the Work is found to be not in accordance with the requirements of the Contract Documents, the Contractor shall correct it promptly after receipt of written notice from the District to do so. This period of two (2) years shall be extended with respect to portions of the Work first performed after Completion by the period of time between Completion and the actual performance of the Work. This obligation hereunder shall survive District's acceptance of the Work under the Contract and termination of the Contract. The District shall give such notice promptly after discovery of the condition.

23.3 District's Right to Perform Work

23.3.1 If the Contractor should neglect to prosecute the Work properly or fail to perform any provisions of this contract, the District, after **FORTY-EIGHT (48)** hours' written notice to the Contractor, may, without prejudice to any other remedy it may have, make good such deficiencies and may deduct the cost thereof from the payment then or thereafter due the Contractor.

23.3.2 If it is found at any time, before or after completion of the Work, that Contractor has varied from the Drawings and/or Specifications, including, but not limited to, variation in material, quality, form, or finish, or in the amount or value of the materials and labor used, District may require at its option:

23.3.2.1 That all such improper Work be removed, remade or replaced, and all work disturbed by these changes be made good by Contractor at no additional cost to the District;

23.3.2.2 That the District deduct from any amount due Contractor the sum of money equivalent to the difference in value between the work performed and that called for by the Drawings and Specifications; or

23.3.2.3 That the District exercise any other remedy it may have at law or under the Contract Documents, including but not limited to the District hiring its own forces or another contractor to replace the Contractor's nonconforming Work, in which case the District shall either issue a deductive Change Order, a Construction Change Directive, or invoice the Contractor for the cost of that work. Contractor shall pay any invoices within thirty (30) days of receipt of same or District may withhold those amounts from payment(s) to Contractor.

24. TERMINATION AND SUSPENSION

24.1 District's Request for Assurances

If District at any time reasonably believes Contractor is or may be in default under this Contract, District may in its sole discretion notify Contractor of this fact and request written assurances from Contractor of performance of Work and a written plan from Contractor to remedy any potential default under the terms this Contract that the District may advise Contractor of in writing. Contractor shall, within ten (10) calendar days of District's request, deliver a written cure plan that meets the District's requirements in its request for assurances. Contractor's failure to provide such written assurances of performance and the required written plan, within ten (10) calendar days of request, will constitute a material breach of this Contract sufficient to justify termination for cause.

24.2 District's Right to Terminate Contractor for Cause

24.2.1 Grounds for Termination: The District, in its sole discretion, may terminate the Contract and/or terminate the Contractor's right to perform the work of the Contract based upon any of the following:

24.2.1.1 Contractor refuses or fails to execute the Work or any separable part thereof with sufficient diligence as will ensure its completion within the time specified or any extension thereof, or

24.2.1.2 Contractor fails to complete said Work within the time specified or any extension thereof, or

24.2.1.3 Contractor persistently fails or refuses to perform Work or provide material of sufficient quality as to be in compliance with Contract Documents; or

24.2.1.4 Contractor persistently refuses, or repeatedly fails, except in cases for which extension of time is provided, to supply enough properly skilled workers or proper materials to complete the Work in the time specified; or

24.2.1.5 Contractor fails to make prompt payment to Subcontractors, or for material, or for labor; or

24.2.1.6 Contractor persistently disregards laws, or ordinances, or instructions of District; or

24.2.1.7 Contractor fails to supply labor, including that of Subcontractors, that is sufficient to prosecute the Work or that can work in harmony with all other elements of labor employed or to be employed on the Work; or

24.2.1.8 Contractor or its Subcontractor(s) is/are otherwise in breach, default, or in substantial violation of any provision of this Contract, including but not limited to a lapse in licensing or registration.

24.2.2 Notification of Termination

24.2.2.1 Upon the occurrence at District's sole determination of any of the above conditions, District may, without prejudice to any other right or remedy, serve written notice upon Contractor and its Surety of District's termination of this Contract and/or the Contractor's right to perform the work of the Contract. This notice will contain the reasons for termination. Unless, within three (3) days after the service of the notice, any and all condition(s) shall cease, and any and all violation(s) shall cease, or arrangement satisfactory to District for the correction of the condition(s) and/or violation(s) be made, this Contract and/or the Contractor's right to perform the Work of the Contract shall cease and terminate. Upon termination, Contractor shall not be entitled to receive any further payment until the entire Work is finished.

24.2.2.2 Upon termination, District may immediately serve written notice of tender upon Surety whereby Surety shall have the right to take over and perform this Contract only if Surety:

24.2.2.2.1 Within three (3) days after service upon it of the notice of tender, gives District written notice of Surety's intention to take over and perform this Contract; and

24.2.2.2.2 Commences performance of this Contract within three (3) days from date of serving of its notice to District.

24.2.2.3 Surety shall not utilize Contractor in completing the Project if the District notifies Surety of the District's objection to Contractor's further participation in the completion of the Project. Surety expressly agrees that any contractor which Surety proposes to fulfill Surety's obligations is subject to District's approval. District's approval shall not be unreasonably withheld, conditioned or delayed.

24.2.2.4 If Surety fails to notify District or begin performance as indicated herein, District may take over the Work and execute the Work to completion by any method it may deem advisable at the expense of Contractor and/or its Surety. Contractor and/or its Surety shall be liable to District for any excess cost or other damages the District incurs thereby. Time is of the essence in this Contract. If the District takes over the Work as herein provided, District may, without liability for so doing, take possession of and utilize in completing the Work such materials, appliances, plan, and other property belonging to Contractor as may be on the Site of the Work, in bonded storage, or previously paid for.

24.3 Termination of Contractor for Convenience

24.3.1 District in its sole discretion may terminate the Contract in whole or in part upon three (3) days' written notice to the Contractor.

24.3.2 Upon notice, Contractor shall:

24.3.2.1 Cease operations as directed by the District in the notice;

24.3.2.2 Take necessary actions for the protection and preservation of the Work as soon as possible; and

24.3.2.3 Terminate all existing subcontracts and purchase orders and enter into no further subcontracts and purchase orders.

24.3.3 Within 30 days of the notice, Contractor submit to the District a payment application for the actual cost for labor, materials, and services performed, including all Contractor's and Subcontractor(s)' mobilization and/or demobilization costs, that is unpaid. Contractor shall have no claims against the District except for the actual cost for labor, materials, and services performed that adequately documented through timesheets, invoices, receipts, or otherwise. District shall pay all undisputed invoice(s) for work performed until the notice of termination.

24.3.4 Under a termination for convenience, the District retains the right to all the options available to the District if there is a termination for cause.

24.4 Effect of Termination

24.4.1 Contractor shall, only if ordered to do so by the District, immediately remove from the Site all or any materials and personal property belonging to Contractor that have not been incorporated in the construction of the Work, or which are not in place in the Work. The District retains the right, but not the obligation, to keep and use any materials and personal property belonging to Contractor that have not been incorporated in the construction of the Work, or which are not in place in the Work. The Contractor and its Surety shall be liable upon the Performance Bond for all damages caused to the District by reason of the Contractor's failure to complete the Contract.

24.4.2 In the event that the District shall perform any portion of, or the whole of the Work, pursuant to the provisions of the General Conditions, the District shall not be liable nor account to the Contractor in any way for the time within which, or the manner in which, the Work is performed by the District or for any changes the District may make in the Work or for the money expended by the District in satisfying claims and/or suits and/or other obligations in connection with the Work.

24.4.3 In the event termination for cause is determined to have not been for cause, the termination shall be deemed to have been a termination for convenience effective as of the same date as the purported termination for cause.

24.4.4 In the event that the Contract is terminated for any reason, no allowances or compensation will be granted for the loss of any anticipated profit by the Contractor or any impact or impairment of Contractor's bonding capacity.

24.4.5 If the expense to the District to finish the Work exceeds the unpaid Contract Price, Contractor and Surety shall pay difference to District within twenty-one (21) days of District's request.

24.4.6 The District shall have the right (but shall have no obligation) to assume and/or assign to a general contractor or construction manager or other third party who is qualified and has sufficient resources to complete the Work, the rights of the Contractor under its subcontracts with any or all Subcontractors. In the event of an assumption or assignment by the District, no Subcontractor shall have any claim against the District or third party for Work performed by Subcontractor or other matters arising prior to termination of the Contract. The District or any third party,

as the case may be, shall be liable only for obligations to the Subcontractor arising after assumption or assignment. Should the District so elect, the Contractor shall execute and deliver all documents and take all steps, including the legal assignment of its contractual rights, as the District may require, for the purpose of fully vesting in the District the rights and benefits of its Subcontractor under Subcontracts or other obligations or commitments. All payments due the Contractor hereunder shall be subject to a right of offset by the District for expenses and damages suffered by the District as a result of any default, acts, or omissions of the Contractor. Contractor must include this assignment provision in all of its contracts with its Subcontractors.

24.4.7 The foregoing provisions are in addition to and not in limitation of any other rights or remedies available to District.

24.5 Emergency Termination of Public Contracts Act of 1949

24.5.1 This Contract is subject to termination as provided by sections 4410 and 4411 of the Government Code of the State of California, being a portion of the Emergency Termination of Public Contracts Act of 1949.

24.5.1.1 Section 4410 of the Government Code states:

In the event a national emergency occurs, and public work, being performed by contract, is stopped, directly or indirectly, because of the freezing or diversion of materials, equipment or labor, as the result of an order or a proclamation of the President of the United States, or of an order of any federal authority, and the circumstances or conditions are such that it is impracticable within a reasonable time to proceed with a substantial portion of the work, then the public agency and the contractor may, by written agreement, terminate said contract.

24.5.1.2 Section 4411 of the Government Code states:

Such an agreement shall include the terms and conditions of the termination of the contract and provision for the payment of compensation or money, if any, which either party shall pay to the other or any other person, under the facts and circumstances in the case.

24.5.2 Compensation to the Contractor shall be determined at the sole discretion of District on the basis of the reasonable value of the Work done, including preparatory work. As an exception to the foregoing and at the District's discretion, in the case of any fully completed separate item or portion of the Work for which there is a separate previously submitted unit price or item on the accepted schedule of values, that price shall control. The District, at its sole discretion, may adopt the Contract Price as the reasonable value of the work done or any portion thereof.

24.6 Suspension of Work

24.6.1 District in its sole discretion may suspend, delay or interrupt the Work in whole or in part for such period of time as the District may determine upon three (3) days written notice to the Contractor.

24.6.1.1 An adjustment may be made for changes in the cost of performance of the Work caused by any such suspension, delay or interruption. No adjustment shall be made to the extent:

24.6.1.1.1 That performance is, was or would have been so suspended, delayed or interrupted by another cause for which Contractor is responsible; or

24.6.1.1.2 That an equitable adjustment is made or denied under another provision of the Contract; or

24.6.1.1.3 That the suspension of Work was the direct or indirect result of Contractor's failure to perform any of its obligations hereunder.

24.6.1.2 Any adjustments in cost of performance may have a fixed or percentage fee as provided in the section on Format for Proposed Change Order herein. This amount shall be full compensation for all Contractor's and its Subcontractor(s)' changes in the cost of performance of the Contract caused by any such suspension, delay or interruption.

25. CLAIMS PROCESS

25.1 Obligation to File Claims for Disputed Work

25.1.1 Should Contractor otherwise seek extra time or compensation for any reason whatsoever ("Disputed Work"), then Contractor shall first follow procedures set forth in the Contract Documents including, without limitation, Articles 15, 16 and 17, all of which are conditions precedent to submitting a Claim pursuant to Article 25. A Notice of Delay or Proposed Change Order are less formal procedures that proceed the formal claim and do not constitute a Claim. A Claim also does not include correspondence, RFIs, vouchers, invoices, progress payment applications, or other routine or authorized form of requests for progress payments in compliance with the Contract. If a dispute remains, then Contractor shall give written notice to District that expressly invokes this Article 25 within the time limits set forth herein.

25.1.2 Contractor's sole and exclusive remedy for Disputed Work is to file a written claim setting forth Contractor's position as required herein within the time limits set forth herein.

25.2 Duty to Perform during Claim Process

Contractor and its subcontractors shall continue to perform its Work under the Contract including the disputed work, and shall not cause a delay of the Work during any dispute, claim, negotiation, mediation, or arbitration proceeding, except by written agreement by the District.

25.3 Definition of Claim

25.3.1 Pursuant to Public Contract Code section 9204, the term "Claim" means a separate demand by the Contractor sent by registered mail or certified mail with return receipt requested, for one or more of the following:

25.3.1.1 A time extension, including without limitation, for relief of damages or penalties for delay assessed by the District under the Contract;

25.3.1.2 Payment by the District of money or damages arising from work done by, or on behalf of, the Contractor pursuant to the Contract and payment of which is not otherwise expressly provided for or to which Contractor is not otherwise entitled to; or

25.3.1.3 An amount of payment disputed by the District.

25.4 Claims Presentation

25.4.1 Form and Contents of Claim

25.4.1.1 If Contractor intends to submit a Claim for an increase in the Contract Price and/or Contract Time for any reason including, without limitation, the acts of District or its agents, Contractor shall, within thirty (30) days after the event giving rise to the Claim, give notice of the Claim ("Notice of Potential Claim") in writing specifically identifying Contractor is invoking this Article 25 Claims Presentation. The Notice of Potential Claim shall provide Contractor's preliminary request for an adjustment to the Contract Price and/or Contract Time, with a description of the grounds therefore.

25.4.1.2 Within thirty (30) days after serving the written Notice of Potential Claim, Contractor shall provide a Claim including an itemized statement of the details and amounts of its Claim for any increase in the Contract Price of Contract Time as provided below, including a Time Impact Analysis and any and all other documentation substantiating Contractor's claimed damages:

25.4.1.2.1 The issues, events, conditions, circumstances and/or causes giving rise to the dispute, and shall show, in detail, the cause and effect of same;

25.4.1.2.2 Citation to provisions in the Contract Documents, statute sections, and/or case law entitling Contractor to an increase in the Contract Price or Contract Time;

25.4.1.2.3 The pertinent dates and/or durations and actual and/or anticipated effects on the Contract Price, Contract Schedule milestones and/or Contract Time adjustments;

25.4.1.2.4 The Time Impact Analysis of all time delays that shows actual time impact on the critical path; and

25.4.1.2.5 The line-item costs for labor, material, and/or equipment, if applicable, for all cost impacts priced like a change order according to Article 17 and must be updated monthly as to cost and entitlement if a continuing claim.

25.4.1.3 The Claim shall include the following certification by the Contractor:

25.4.1.3.1 The undersigned Contractor certifies under penalty of perjury that the attached dispute is made in good faith; that the supporting data is accurate and complete to the best of my knowledge and belief; that the amount requested accurately reflects the adjustment for which Contractor believes the District is liable; and that I am duly authorized to certify the dispute on behalf of the Contractor.

25.4.1.3.2 Furthermore, Contractor understands that the value of the attached dispute expressly includes any and all of the Contractor's costs and expenses, direct and indirect, resulting from the Work performed on the Project, additional time required on the Project and/or resulting from delay to the Project including, without limitation, cumulative impacts. Contractor may not separately recover for overhead or other indirect costs. Any costs, expenses, damages, or time extensions not included are deemed waived.

25.4.2 Contractor shall bear all costs incurred in the preparation and submission of a Claim.

25.4.3 Failure to timely submit a Claim and the requisite supporting documentation shall constitute a waiver of Contractor's claim(s) against the District and Contractor's Claim(s) for compensation or an extension of time shall be deemed waived, released, and discharged as to any entitlement for adjustment to Contract Price and/or Contract Time.

25.5 Claim Resolution pursuant to Public Contract Code section 9204

Contractor may request to waive the claims procedure under Public Contract Code section 9204 and proceed directly to the commencement of a civil action or binding arbitration. If Contractor chooses to proceed, Contractor shall comply with the following steps:

25.5.1 STEP 1:

25.5.1.1 Upon receipt of a Claim by registered or certified mail, return receipt requested, including the documents necessary to substantiate it, the District shall conduct a reasonable review of the Claim and, within a period not to exceed 45 days, shall provide the Contractor a written statement identifying what portion of the Claim is disputed and what portion is undisputed. Upon receipt of a Claim, the District and Contractor may, by mutual agreement, extend the time period to provide a written statement. If the District needs approval from its governing body to provide the Contractor a written statement identifying the disputed portion and the undisputed portion of the Claim, and the governing body does not meet within the 45 days or within the mutually agreed to extension of time following receipt of Claim sent by registered mail or certified mail, return receipt requested, the District shall have up to three (3) days following the next duly publicly noticed meeting of the governing body after the 45-day period, or extension, expires to provide Contractor a written statement identifying the disputed portion and the undisputed portion.

25.5.1.1.1 Any payment due on an undisputed portion of the Claim shall be processed and made within 60 days after the District issues its written

statement. Amounts not paid in a timely manner as required by this section, section 25.4, shall bear interest at seven percent (7%) per annum.

25.5.1.2 Upon receipt of a Claim, the parties may mutually agree to waive, in writing, mediation and proceed directly to the commencement of a civil action or binding arbitration, as applicable. In this instance, District and Contractor must comply with the sections below regarding Public Contract Code section 20104 et seq. and Government Code Claim Act Claims.

25.5.1.3 If the District fails to issue a written statement, or to otherwise meet the time requirements of this section, this shall result in the Claim being deemed rejected in its entirety. A Claim that is denied by reason of the District's failure to have responded to a Claim, or its failure to otherwise meet the time requirements of this section, shall not constitute an adverse finding with regard to the merits of the Claim or the responsibility or qualifications of Contractor.

25.5.2 STEP 2:

25.5.2.1 If Contractor disputes the District's written response, or if the District fails to respond to a Claim within the time prescribed, Contractor may demand in writing an informal conference to meet and confer for settlement of the issues in dispute. Upon receipt of a demand in writing sent by registered mail or certified mail, return receipt requested, the District shall schedule a meet and confer conference within 30 days for settlement of the dispute. Within 10 business days following the conclusion of the meet and confer conference, if the Claim or any portion of the Claim remains in dispute, the District shall provide the Contractor a written statement identifying the portion of the Claim that remains in dispute and the portion that is undisputed.

25.5.2.1.1.1 Any payment due on an undisputed portion of the Claim shall be processed and made within 60 days after the District issues its written statement. Amounts not paid in a timely manner as required by this section, section 25.4, shall bear interest at seven percent (7%) per annum.

25.5.3 STEP 3:

25.5.3.1 Any disputed portion of the Claim, as identified by Contractor in writing, shall be submitted to nonbinding mediation, with the District and Contractor sharing the associated costs equally. The District and Contractor shall mutually agree to a mediator within 10 business days after the disputed portion of the Claim has been identified in writing. If the parties cannot agree upon a mediator, each party shall select a mediator and those mediators shall select a qualified neutral third party to mediate with regard to the disputed portion of the Claim. Each party shall bear the fees and costs charged by its respective mediator in connection with the selection of the neutral mediator. If mediation is unsuccessful, the parts of the Claim remaining in dispute shall be subject to applicable procedures outside this section.

25.5.3.1.1 For purposes of this section, mediation includes any nonbinding process, including, but not limited to, neutral evaluation or a dispute review board, in which an independent third party or board assists the parties in

dispute resolution through negotiation or by issuance of an evaluation. Any mediation utilized shall conform to the timeframes in this section.

25.5.3.2 Unless otherwise agreed to by the District and Contractor in writing, the mediation conducted pursuant to this section shall excuse any further obligation under Public Contract Code section 20104.4 to mediate after litigation has been commenced.

25.5.4 STEP 4:

25.5.4.1 If mediation under this section does not resolve the parties' dispute, the District may, but does not require arbitration of disputes under private arbitration or the Public Works Contract Arbitration Program.

25.6 Subcontractor Pass-Through Claims

25.6.1 If a subcontractor or a lower tier subcontractor lacks legal standing to assert a claim against a District because privity of contract does not exist, the contractor may present to the District a Claim on behalf of a subcontractor or lower tier subcontractor. A subcontractor may request in writing, either on his or her own behalf or on behalf of a lower tier subcontractor, that Contractor present a Claim for work which was performed by the subcontractor or by a lower tier subcontractor on behalf of the subcontractor. The subcontractor requesting that the Claim be presented to the District shall furnish reasonable documentation to support the Claim.

25.6.2 Within 45 days of receipt of this written request from a subcontractor, Contractor shall notify the subcontractor in writing as to whether the Contractor presented the Claim to the District and, if Contractor did not present the Claim, provide the subcontractor with a statement of the reasons for not having done so.

25.6.3 The Contractor shall bind all its Subcontractors to the provisions of this section and will hold the District harmless against Claims by Subcontractors.

25.7 Government Code Claim Act Claim

25.7.1 If a claim, or any portion thereof, remains in dispute upon satisfaction of all applicable Claim Resolution requirements the Contractor shall comply with all claims presentation requirements as provided in Chapter 1 (commencing with section 900) and Chapter 2 (commencing with section 910) of Part 3 of Division 3.6 of Title 1 of Government Code as a condition precedent to the Contractor's right to bring a civil action against the District.

25.7.2 Contractor shall bear all costs incurred in the preparation, submission and administration of a Claim. Any claims presented in accordance with the Government Code must affirmatively indicate Contractor's prior compliance with the claims procedure herein of the claims asserted.

25.7.3 For purposes of those provisions, the running of the time within which a claim pursuant to Public Contract Code section 20104.2 only must be presented to the District shall be tolled from the time the claimant submits his or her written claim pursuant to subdivision (a) until the time that claim is denied as a result of the meet

and confer process, including any period of time utilized by the meet and confer process.

25.8 Claim Resolution pursuant to Public Contract Code section 20104 et seq.

25.8.1 In the event of a disagreement between the parties as to performance of the Work, the interpretation of this Contract, or payment or nonpayment for Work performed or not performed, the parties shall attempt to resolve all claims of three hundred seventy-five thousand dollars (\$375,000) or less which arise between Contractor and District by those procedures set forth in Public Contract Code section 20104, et seq., to the extent applicable.

25.8.1.1 Contractor shall file with the District any written Claim, including the documents necessary to substantiate it, upon the application for final payment.

25.8.1.2 For claims of less than fifty thousand dollars (\$50,000), the District shall respond in writing within forty-five (45) days of receipt of the Claim or may request in writing within thirty (30) days of receipt of the Claim any additional documentation supporting the Claim or relating to defenses or claims the District may have against the Contractor.

25.8.1.2.1 If additional information is required, it shall be requested and provided by mutual agreement of the parties.

25.8.1.2.2 District's written response to the documented Claim shall be submitted to the Contractor within fifteen (15) days after receipt of the further documentation or within a period of time no greater than that taken by the Contractor to produce the additional information, whichever is greater.

25.8.1.3 For claims of over fifty thousand dollars (\$50,000) and less than or equal to three hundred seventy-five thousand dollars (\$375,000), the District shall respond in writing to all written Claims within sixty (60) days of receipt of the claim, or may request, in writing, within thirty (30) days of receipt of the Claim any additional documentation supporting the Claim or relating to defenses or claims the District may have against the Contractor.

25.8.1.3.1 If additional information is required, it shall be requested and provided upon mutual agreement of the District and the Contractor.

25.8.1.3.2 The District's written response to the Claim, as further documented, shall be submitted to the Contractor within thirty (30) days after receipt of the further documentation, or within a period of time no greater than that taken by the Contractor to produce the additional information or requested documentation, whichever is greater.

25.8.1.4 If Contractor disputes the District's written response, or the District fails to respond within the time prescribed, Contractor may so notify the District, in writing, either within fifteen (15) days of receipt of the District's response or within fifteen (15) days of the District's failure to respond within the time prescribed, respectively, and demand an informal conference to meet and confer for settlement of the issues in dispute. Upon a demand, the District shall

schedule a meet and confer conference within thirty (30) days for settlement of the dispute.

25.8.1.5 Following the meet and confer conference, if the Claim or any portion of it remains in dispute, the Contractor may file a claim as provided in Chapter 1 (commencing with Section 900) and Chapter 2 (commencing with Section 910) of Part 3 of Division 3.6 of Title 1 of the Government Code. For purposes of those provisions the running of the time within which a claim must be filed shall be tolled from the time the Contractor submits its written Claim until the time the Claim is denied, including any period of time utilized by the meet and confer process.

25.8.1.6 For any civil action filed to resolve claims filed pursuant to this section, within sixty (60) days, but no earlier than thirty (30) days, following the filing of responsive pleadings, the court shall submit the matter to nonbinding mediation unless waived by mutual stipulation of both parties. The mediation process shall provide for the selection within fifteen (15) days by both parties of a disinterested third person as mediator, shall be commenced within thirty (30) days of the submittal, and shall be concluded within fifteen (15) days from the commencement of the mediation unless a time requirement is extended upon a good cause showing to the court or by stipulation of both parties. If the parties fail to select a mediator within the 15-day period, any party may petition the court to appoint the mediator.

25.8.1.7 If the matter remains in dispute, the case shall be submitted to judicial arbitration pursuant to Chapter 2.5 (commencing with Section 1141.10) of the Title 3 of Part 3 of the Code of Civil Procedure, notwithstanding Section 1141.11 of that code. The Civil Discovery Act of 1986, (Article 3 (commencing with Section 2016) of Chapter 3 of Title 3 of part 4 of the Code of Civil Procedure) shall apply to any proceeding brought under this subdivision consistent with the rules pertaining to judicial arbitration.

25.8.1.8 The District shall not fail to pay money as to any portion of a Claim which is undisputed except as otherwise provided in the Contract Documents. In any suit filed pursuant to this section, the District shall pay interest due at the legal rate on any arbitration award or judgment. Interest shall begin to accrue on the date the suit is filed in a court of law.

25.8.2 Contractor shall bind its Subcontractors to the provisions of this Section and will hold the District harmless against disputes by Subcontractors.

25.9 Claim Procedure Compliance

25.9.1 Failure to submit and administer claims as required in Article 25 shall waive Contractor's right to claim on any specific issues not included in a timely submitted claim. Claim(s) not raised in a timely protest and timely claim submitted under this Article 25 may not be asserted in any subsequent litigation, Government Code Claim, or legal action.

25.9.2 District shall not be deemed to waive any provision under this Article 25, if at District's sole discretion, a claim is administered in a manner not in accord with this Article 25. Waivers or modifications of this Article 25 may only be made by a

signed change order approved as to form by legal counsel for both District and Contractor; oral or implied modifications shall be ineffective.

25.10 Claim Resolution Non-Applicability

25.10.1 The procedures for dispute and claim resolutions set forth in this Article shall not apply to the following:

25.10.1.1 Personal injury, wrongful death or property damage claims;

25.10.1.2 Latent defect or breach of warranty or guarantee to repair;

25.10.1.3 Stop payment notices;

25.10.1.4 District's rights set forth in the Article on Suspension and Termination;

25.10.1.5 Disputes arising out of labor compliance enforcement by the Department of Industrial Relations; or

25.10.1.6 District rights and obligations as a public entity set forth in applicable statutes; provided, however, that penalties imposed against a public entity by statutes, including, but not limited to, Public Contract Code sections 20104.50 and 7107, shall be subject to the Claim Resolution requirements provided in this Article.

25.11 Attorney's Fees

25.11.1 Should litigation be necessary to enforce any terms or provisions of this Agreement, then each party shall bear its own litigation and collection expenses, witness fees, court costs, and attorney's fees.

26. STATE LABOR, WAGE & HOUR, APPRENTICE, AND RELATED PROVISIONS

26.1 Labor Compliance and Enforcement

Since this Project is subject to labor compliance and enforcement by the Department of Industrial Relations ("DIR"), Contractor specifically acknowledges and understands that it shall perform the Work of this Agreement while complying with all the applicable provisions of Division 2, Part 7, Chapter 1, of the Labor Code and Title 8 of the California Code of Regulations, including, without limitation, the requirement that the Contractor and all Subcontractors shall timely furnish complete and accurate electronic certified payroll records directly to the DIR. The District may not issue payment if this requirement is not met.

26.2 Wage Rates, Travel, and Subsistence

26.2.1 Pursuant to the provisions of Article 2 (commencing at section 1770), Chapter 1, Part 7, Division 2, of the Labor Code, the general prevailing rate of per diem wages and the general prevailing rate for holiday and overtime work in the locality in which this public work is to be performed for each craft, classification, or type of worker needed to execute this Contract are on file at the District's principal

office and copies will be made available to any interested party on request. Contractor shall obtain and post a copy of these wage rates at the job site.

26.2.2 Holiday and overtime work, when permitted by law, shall be paid for at the general prevailing rate of per diem wages for holiday and overtime work on file with the Director of the Department of Industrial Relations, unless otherwise specified. The holidays upon which those rates shall be paid need not be specified by the District, but shall be all holidays recognized in the applicable collective bargaining agreement. If the prevailing rate is not based on a collectively bargained rate, the holidays upon which the prevailing rate shall be paid shall be as provided in Section 6700 of the Government Code.

26.2.3 Contractor shall pay and shall cause to be paid each worker engaged in Work on the Project the general prevailing rate of per diem wages determined by the Director of the Department of Industrial Relations, regardless of any contractual relationship which may be alleged to exist between Contractor or any Subcontractor and such workers.

26.2.4 If during the period this bid is required to remain open, the Director of the Department of Industrial Relations determines that there has been a change in any prevailing rate of per diem wages in the locality in which the Work under the Contract is to be performed, such change shall not alter the wage rates in the Notice to Bidders or the Contract subsequently awarded.

26.2.5 Pursuant to Labor Code section 1775, Contractor shall, as a penalty to District, forfeit the statutory amount (believed by the District to be currently up to two hundred dollars (\$200) for each calendar day, or portion thereof, for each worker paid less than the prevailing rates, determined by the District and/or the Director, for the work or craft in which that worker is employed for any public work done under Contract by Contractor or by any Subcontractor under it. The difference between such prevailing wage rates and the amount paid to each worker for each calendar day or portion thereof for which each worker was paid less than the prevailing wage rate shall be paid to each worker by Contractor.

26.2.6 Any worker employed to perform Work on the Project, which Work is not covered by any classification listed in the general prevailing wage rate of per diem wages determined by the Director, shall be paid not less than the minimum rate of wages specified therein for the classification which most nearly corresponds to Work to be performed by him, and such minimum wage rate shall be retroactive to time of initial employment of such person in such classification.

26.2.7 Pursuant to Labor Code section 1773.1, per diem wages are deemed to include employer payments for health and welfare, pension, vacation, travel time, subsistence pay, and apprenticeship or other training programs authorized by Labor Code section 3093, and similar purposes.

26.2.8 Contractor shall post at appropriate conspicuous points on the Site of Project, a schedule showing all determined minimum wage rates and all authorized deductions, if any, from unpaid wages actually earned. In addition, Contractor shall post a sign-in log for all workers and visitors to the Site, a list of all subcontractors of any tier on the Site, and the required Equal Employment Opportunity poster(s).

26.3 Hours of Work

26.3.1 As provided in article 3 (commencing at section 1810), chapter 1, part 7, division 2, of the Labor Code, eight (8) hours of labor shall constitute a legal day's work. The time of service of any worker employed at any time by Contractor or by any Subcontractor on any subcontract under this Contract upon the Work or upon any part of the Work contemplated by this Contract shall be limited and restricted by Contractor to eight (8) hours per day, and forty (40) hours during any one week, except as hereinafter provided. Notwithstanding the provisions hereinabove set forth, Work performed by employees of Contractor in excess of eight (8) hours per day and forty (40) hours during any one week, shall be permitted upon this public work upon compensation for all hours worked in excess of eight (8) hours per day at not less than one and one-half times the basic rate of pay.

26.3.2 Contractor shall keep and shall cause each Subcontractor to keep an accurate record showing the name of and actual hours worked each calendar day and each calendar week by each worker employed by Contractor in connection with the Work or any part of the Work contemplated by this Contract. The record shall be kept open at all reasonable hours to the inspection of District and to the Division of Labor Standards Enforcement of the DIR.

26.3.3 Pursuant to Labor Code section 1813, Contractor shall as a penalty to the District forfeit the statutory amount (believed by the District to be currently twenty-five dollars (\$25)) for each worker employed in the execution of this Contract by Contractor or by any Subcontractor for each calendar day during which such worker is required or permitted to work more than eight (8) hours in any one calendar day and forty (40) hours in any one calendar week in violation of the provisions of article 3 (commencing at section 1810), chapter 1, part 7, division 2, of the Labor Code.

26.3.4 Any Work necessary to be performed after regular working hours, or on Sundays or other holidays shall be performed without additional expense to the District.

26.4 Payroll Records

26.4.1 Contractor shall upload, and shall cause each Subcontractor performing any portion of the Work under this Contract to upload, an accurate and complete certified payroll record ("CPR") electronically using DIR's eCPR System by uploading the CPRs by electronic XML file or entering each record manually using the DIR's iform (or current form) online on no less than every 30 days while Work is being performed and within 30 days after the final day of Work performed on the Project and within ten (10) days of any request by the District or Labor Commissioner at <http://www.dir.ca.gov/Public-Works/Certified-Payroll-Reporting.html> or current application and URL, showing the name, address, social security number, work classification, straight-time, and overtime hours worked each day and week, and the actual per diem wages paid to each journeyman, apprentice, worker, or other employee employed by the Contractor and/or each Subcontractor in connection with the Work.

26.4.1.1 The CPRs enumerated hereunder shall be filed directly with the DIR on a weekly basis or to the requesting party, whether the District or DIR, within ten (10) days after receipt of each written request. The CPRs from the Contractor

and each Subcontractor for each week shall be provided on or before Wednesday of the week following the week covered by the CPRs. District may not make any payment to Contractor until:

26.4.1.1.1 Contractor and/or its Subcontractor(s) provide CPRs acceptable to the DIR; and

26.4.1.1.2 Any delay in Contractor and/or its Subcontractor(s) providing CPRs to the DIR in a timely manner may directly delay Contractor's payment.

26.4.2 All CPRs shall be available for inspection at all reasonable hours at the principal office of Contractor on the following basis:

26.4.2.1 A certified copy of an employee's CPR shall be made available for inspection or furnished to the employee or his/her authorized representative on request.

26.4.2.2 CPRs shall be made available for inspection or furnished upon request to a representative of District, Division of Labor Standards Enforcement, Division of Apprenticeship Standards, and/or the DIR.

26.4.2.3 CPRs shall be made available upon request by the public for inspection or copies thereof made; provided, however, that a request by the public shall be made through the District, Division of Apprenticeship Standards, or the Division of Labor Standards Enforcement. If the requested CPRs have not been provided pursuant to the provisions herein, the requesting party shall, prior to being provided the records, reimburse the costs of preparation by Contractor, Subcontractors, and the entity through which the request was made. The public shall not be given access to the records at the principal office of Contractor.

26.4.3 Any copy of records made available for inspection as copies and furnished upon request to the public or any public agency by District, Division of Apprenticeship Standards, or Division of Labor Standards Enforcement shall be marked or obliterated in such a manner as to prevent disclosure of an individual's name, address, and social security number. The name and address of Contractor awarded Contract or performing Contract shall not be marked or obliterated.

26.4.4 Contractor shall inform District of the location of the records enumerated hereunder, including the street address, city, and county, and shall, within five (5) working days, provide a notice of change of location and address.

26.4.5 In the event of noncompliance with the requirements of this section, Contractor shall have ten (10) days in which to comply subsequent to receipt of written notice specifying in what respects Contractor must comply with this section. Should noncompliance still be evident after the ten (10) day period, Contractor shall, as a penalty to District, forfeit up to one hundred dollars (\$100) for each calendar day, or portion thereof, for each worker, until strict compliance is effectuated. Upon the request of the Labor Commissioner, these penalties shall be withheld from progress payments then due.

26.4.6 As Contractor and its subcontractors have agreed to be bound by the terms of the PLA entered into by the District on June 9, 2022, Contractor and its

subcontractors may be excused from uploading CPRs electronically using DIR's eCPR System by uploading the CPRs by electronic XML file or entering each record manually using the DIR's iform (or current form) online at <http://www.dir.ca.gov/Public-Works/Certified-Payroll-Reporting.html> , or by using a more current application and URL. However, within ten (10) days of any request by the District or Labor Commissioner, Contractor and its subcontractors shall provide CPRs showing the name, address, social security number, work classification, straight time, and overtime hours worked each day and week, and the actual per diem wages paid to each journeyman, apprentice, worker, or other employee employed by the Contractor and/or each subcontractor in connection with the Work.

26.5 Apprentices

26.5.1 Contractor acknowledges and agrees that, if this Contract involves a dollar amount greater than, or a number of working days greater than that specified in Labor Code section 1777.5, then this Contract is governed by the provisions of Labor Code Section 1777.5. It shall be the responsibility of Contractor to ensure compliance with this Article and with Labor Code section 1777.5 for all apprenticeship occupations.

26.5.2 Apprentices of any crafts or trades may be employed and, when required by Labor Code section 1777.5, shall be employed provided they are properly registered in full compliance with the provisions of the Labor Code.

26.5.3 Every such apprentice shall be paid the standard wage paid to apprentices under the regulations of the craft or trade at which he/she is employed, and shall be employed only at the work of the craft or trade to which she/he is registered.

26.5.4 Only apprentices, as defined in section 3077 of the Labor Code, who are in training under apprenticeship standards and written apprentice agreements under chapter 4 (commencing at section 3070), division 3, of the Labor Code, are eligible to be employed. The employment and training of each apprentice shall be in accordance with the provisions of the apprenticeship standards and apprentice agreements under which he/she is training.

26.5.5 Pursuant to Labor Code section 1777.5, if that section applies to this Contract as indicated above, Contractor and any Subcontractors employing workers in any apprenticeable craft or trade in performing any Work under this Contract shall apply to the applicable joint apprenticeship committee for a certificate approving the Contractor or Subcontractor under the applicable apprenticeship standards and fixing the ratio of apprentices to journeymen employed in performing the Work.

26.5.6 Pursuant to Labor Code section 1777.5, if that section applies to this Contract as indicated above, Contractor and any Subcontractor may be required to make contributions to the apprenticeship program.

26.5.7 If Contractor or Subcontractor willfully fails to comply with Labor Code section 1777.5, then, upon a determination of noncompliance by the Administrator of Apprenticeship, it shall:

26.5.7.1 Be denied the right to bid on any subsequent project for one (1) year from the date of such determination;

26.5.7.2 Forfeit as a penalty to District the full amount as stated in Labor Code section 1777.7. Interpretation and enforcement of these provisions shall be in accordance with the rules and procedures of the California Apprenticeship Council and under the authority of the Chief of the Division of Apprenticeship Standards.

26.5.8 Contractor and all Subcontractors shall comply with Labor Code section 1777.6, which section forbids certain discriminatory practices in the employment of apprentices.

26.5.9 Contractor shall become fully acquainted with the law regarding apprentices prior to commencement of the Work. Special attention is directed to sections 1777.5, 1777.6, and 1777.7 of the Labor Code, and title 8, California Code of Regulations, section 200 et seq. Questions may be directed to the State Division of Apprenticeship Standards, 455 Golden Gate Avenue, 9th floor, San Francisco, California 94102.

26.6 Non-Discrimination

26.6.1 Contractor herein agrees to comply with the provisions of the California Fair Employment and Housing Act as set forth in part 2.8 of division 3 of the California Government Code, commencing at section 12900; the Federal Civil Rights Act of 1964, as set forth in Public Law 88-352, and all amendments thereto; Executive Order 11246; and all administrative rules and regulations found to be applicable to Contractor and Subcontractor.

26.6.2 Special requirements for Federally Assisted Construction Contracts: During the performance of this Contract, Contractor agrees to incorporate in all subcontracts the provisions set forth in Chapter 60-1.4(b) of Title 41 published in Volume 33 No. 104 of the Federal Register dated May 28, 1968.

26.7 Labor First Aid

Contractor shall maintain emergency first aid treatment for Contractor's workers on the Project which complies with the Federal Occupational Safety and Health Act of 1970 (29 U.S.C. § 651 et seq.) and the California Occupational Safety and Health Act of 1973 (Lab. Code, § 6300 et seq.; 8 Cal. Code of Regs., § 330 et seq.).

27. [RESERVED]

28. MISCELLANEOUS

28.1 Assignment of Antitrust Actions

28.1.1 Section 7103.5(b) of the Public Contract Code states:

In entering into a public works contract or subcontract to supply goods, services, or materials pursuant to a public works contract, the Contractor or subcontractor offers and agrees to assign to the awarding body all rights, title, and interest in and to all causes of action it may have under Section 4 of the Clayton Act (15 U.S.C. Sec. 15) or under the Cartwright Act (Chapter 2 (commencing with Section 16700) of Part 2 of Division 7 of the Business and Professions Code), arising from purchases of goods, which assignment shall be made and become effective at the time the awarding body

tenders final payment to the Contractor, without further acknowledgment by the parties.

28.1.2 Section 4552 of the Government Code states:

In submitting a bid to a public purchasing body, the bidder offers and agrees that if the bid is accepted, it will assign to the purchasing body all rights, title, and interest in and to all causes of action it may have under Section 4 of the Clayton Act (15 U.S.C. Sec. 15) or under the Cartwright Act (Chapter 2 (commencing with Section 16700) of Part 2 of Division 7 of the Business and Professions Code), arising from purchases of goods, materials, or services by the bidder for sale to the purchasing body pursuant to the bid. Such assignment shall be made and become effective at the time the purchasing body tenders final payment to the bidder.

28.1.3 Section 4553 of the Government Code states:

If an awarding body or public purchasing body receives, either through judgment or settlement, a monetary recovery for a cause of action assigned under this chapter, the assignor shall be entitled to receive reimbursement for actual legal costs incurred and may, upon demand, recover from the public body any portion of the recovery, including treble damages, attributable to overcharges that were paid by the assignor but were not paid by the public body as part of the bid price, less the expenses incurred in obtaining that portion of the recovery.

28.1.4 Section 4554 of the Government Code states:

Upon demand in writing by the assignor, the assignee shall, within one year from such demand, reassign the cause of action assigned under this part if the assignor has been or may have been injured by the violation of law for which the cause of action arose and (a) the assignee has not been injured thereby, or (b) the assignee declines to file a court action for the cause of action.

28.1.5 Under this Article, "public purchasing body" is District and "bidder" is Contractor.

28.2 Excise Taxes

If, under Federal Excise Tax Law, any transaction hereunder constitutes a sale on which a Federal Excise Tax is imposed and the sale is exempt from such Federal Excise Tax because it is a sale to a State or Local Government for its exclusive use, District, upon request, will execute documents necessary to show (1) that District is a political subdivision of the State for the purposes of such exemption, and (2) that the sale is for the exclusive use of District. No Federal Excise Tax for such materials shall be included in any Contract Price.

28.3 Taxes

Contract Price is to include any and all applicable sales taxes or other taxes that may be due in accordance with section 7051 et seq. of the Revenue and Taxation Code, Regulation 1521 of the State Board of Equalization or any other tax code that may be applicable.

28.4 Shipments

Contractor is responsible for any or all damage or loss to shipments until delivered and accepted on Site, as indicated in the Contract Documents. There must be no charge for containers, packing, unpacking, drayage, or insurance. The total Contract Price shall be all inclusive (including sales tax) and no additional costs of any type will be considered.

28.5 Compliance with Government Reporting Requirements

If this Contract is subject to federal or other governmental reporting requirements because of federal or other governmental financing in whole or in part for the Project of which it is part, or for any other reason, Contractor shall comply with those reporting requirements at the request of the District at no additional cost.

END OF DOCUMENT

SPECIAL CONDITIONS

1. Modernization Projects

A. Access. Access to the school buildings and entry to buildings, classrooms, restrooms, mechanical rooms, electrical rooms, or other rooms, for construction purposes, must be coordinated with District and onsite District personnel before Work is to start. Unless agreed to otherwise in writing, only a school custodian will be allowed to unlock and lock doors in existing building(s). The custodian will be available only while school is in session. If a custodian is required to arrive before 7:00 a.m. or leave after 3:30 p.m. to accommodate Contractor's Work, the overtime wages for the custodian will be paid by the Contractor, unless at the discretion of the District, other arrangements are made in advance.

B. Keys. Upon request, the District may, at its own discretion, provide keys to the school site for the convenience of the Contractor. The Contractor agrees to pay all expenses to re-key the entire school site and all other affected District buildings if the keys are lost or stolen, or if any unauthorized party obtains a copy of the key or access to the school.

C. Maintaining Services. The Contractor is advised that Work is to be performed in spaces regularly scheduled for instruction. Interruption and/or periods of shutdown of public access, electrical service, water service, lighting, or other utilities shall be only as arranged in advance with the District. Contractor shall provide temporary services to all facilities interrupted by Contractor's Work.

D. Maintaining Utilities. The Contractor shall maintain in operation during duration of Contract, drainage lines, storm drains, sewers, water, gas, electrical, steam, and other utility service lines within working area.

E. Confidentiality. Contractor shall maintain the confidentiality of all information, documents, programs, procedures and all other items that Contractor encounters while performing the Work. This requirement shall be ongoing and shall survive the expiration or termination of this Contract and specifically includes, without limitation, all student, parent, and employee disciplinary information and health information.

F. Work during Instructional Time. By submitting its bid, Contractor affirms that Work may be performed during ongoing instruction in existing facilities. If so, Contractor agrees to cooperate to the best of its ability to minimize any disruption to school operations and any use of school facilities by the public up to, and including, rescheduling specific work activities, at no additional cost to District.

G. No Work during Student Testing. Contractor shall, at no additional cost to the District and at the District's request, coordinate its Work to not disturb

District students including, without limitation, not performing any Work when students at the Site are taking State or Federally-required tests.

2. Badge Policy for Contractors

All Contractors doing work for the District will provide their workers with identification badges. These badges will be worn by all members of the Contractor's staff who are working in a District facility.

A. Badges must be filled out in full and contain the following information:

2.1.1 Name of Contractor

2.1.2 Name of Employee

2.1.3 Contractor's address and phone number

B. Badges are to be worn when the Contractor or his/her employees are on site and must be visible at all times. Contractors must inform their employees that they are required to allow District employees, the Architect, the Construction Manager, the Program Manager, or the Project Inspector to review the information on the badges upon request.

C. Continued failure to display identification badges as required by this policy may result in the individual being removed from the Project or assessment of fines against the Contractor.

3. Permits, Certificates, Licenses, Fees, Approvals

A. Payment for Permits, Certificates, Licenses, Fees, and Approvals. As required in the General Conditions, the Contractor shall secure and pay for all permits, licenses, approvals, and certificates necessary for the prosecution of the Work with the exception of the following:

N/A

With respect to the above-listed items, Contractor shall be responsible for securing such items; however, District will be responsible for payment of these charges or fees. Contractor shall notify the District of the amount due with respect to such items and to whom the amount is payable. Contractor shall provide the District with an invoice and receipt with respect to such charges or fees.

4. As-Builts and Record Drawings

A. When called for by Division 1, Contractor shall submit As-Built Drawings pursuant to the Contract Documents consisting of one set of computer-

aided design and drafting ("CADD") files, PDF format , plus one set of As-Built Drawings in Hard Copy.

B. Contractor shall submit Record Drawings pursuant to the Contract Documents consisting of one set of computer-aided design and drafting ("CADD") files, PDF format, plus one set of Record Drawings in Hard Copy.

5. Disabled Veteran Business Enterprises

This Project uses or may plan to use funds allocated pursuant to the State of California School Facility Program ("Program") for the construction and/or modernization of school buildings. Therefore, Section 17076.11 of the Education Code requires the District to have a participation goal for disabled veteran business enterprises ("DVBE") of at least three percent (3%), per year, of the overall dollar amount expended each year by the District on projects that receive state funding. The Contractor must submit the Disabled Veteran Business Enterprise Participation Certification to the District with its executed Agreement, identifying the steps Contractor took to solicit DVBE participation in conjunction with this Contract.

6. Construction Manager

The District will use a Construction Manager on the Project that is the subject of this Contract. Kitchell CEM is the Construction Manager for this Project.

7. Program Manager

Chris Ralston, Sac City Unified School District is the Program Manager designated for the Project that is the subject of this Contract.

8. COVID-19 Safety Requirements

Contractor shall, at its cost, timely comply with all applicable federal, State, and local requirements relating to COVID-19 or other public health emergency/epidemic/pandemic. Further, except to the extent the Order provides otherwise, Contractor and Contractor's personnel, subcontractors and suppliers shall continue to comply with all applicable terms in the California Department of Public Health's State Public Health Officer Orders.

9. COVID-19 Vaccination/Testing Requirements

Vaccination Requirements

Contractor shall fill out, sign, date and submit to District the COVID-19 Vaccination/Testing Certification Form, attached hereto as **Attachment "A."**

According to the August 11, 2021, California Department of Public Health ("CDPH") State Public Health Officer Order ("Order"), a person is "fully vaccinated" for COVID-19 if two weeks or more have passed since they have received the second dose in a 2-dose series (Pfizer-BioNTech or Moderna or vaccine authorized by the World Health Organization), or two weeks or more have passed since they received a single-dose vaccine (Johnson and Johnson[J&J]/Janssen).

Pursuant to the CDPH Guidance for Vaccine Records Guidelines & Standards, Contractor shall only accept the following as proof of vaccination:

- (a) COVID-19 Vaccination Record Card (issued by the Department of Health and Human Services Centers for Disease Control & Prevention or WHO Yellow Card which includes name of person vaccinated, type of vaccine provided and date last dose administered);
- (b) a photo of a Vaccination Record Card as a separate document;
- (c) a photo of a Vaccination Record Card stored on a phone or electronic device;
- (d) documentation of COVID-19 vaccination from a health care provider;
- (e) digital record that includes a QR code that when scanned by a SMART Health Card reader displays to the reader name, date of birth, vaccine dates and vaccine type; or
- (f) documentation of vaccination from other contracted employers who follow these vaccination records guidelines and standards.

In the absence of knowledge to the contrary, Contractor may accept the documentation presented in (a) through (f) above as valid.

Contractor shall have a plan in place for tracking verified Contractor personnel vaccination status. Records of vaccination verification must be made available, upon request, to the local health jurisdiction for purposes of case investigation.

Contractor personnel, including any and all tiers of subcontractor, supplier, and any other personnel entering the Project site, who are not fully vaccinated, or for whom vaccine status is unknown or documentation is not provided, must be considered unvaccinated.

Weekly Testing Requirements

Contractor shall ensure that Contractor personnel, including any and all tiers of subcontractor, supplier, and any other worker entering the Project site, who are unvaccinated or who are not fully vaccinated are required to undergo diagnostic screening testing, as specified below:

- (a) Contractor personnel may be tested with either antigen or molecular tests to satisfy this requirement, but unvaccinated or incompletely vaccinated workers must be tested at least once weekly with either PCR testing or antigen testing. Any PCR (molecular) or antigen test used must either have Emergency Use Authorization by the U.S. Food and Drug Administration or be operating per the Laboratory Developed Test requirements by the U.S. Centers for Medicare and Medicaid Services.
- (b) Unvaccinated or not fully vaccinated Contractor personnel must also observe all other infection control requirements, and are not exempted from the testing requirement even if they have a medical contraindication to vaccination, since they are still potentially able to spread the illness. Previous history of COVID-19 from which the individual recovered more than 90 days earlier, or a previous positive antibody test for COVID-19, do not waive this requirement for testing.

Contractor shall have a plan in place for tracking test results and conducting workplace contact tracing, and must report results to local public health departments, if applicable.

[ATTACHMENT "A" ON NEXT PAGE]

ATTACHMENT "A"
COVID-19 VACCINATION/TESTING CERTIFICATION

Contractor: _____

The California Department of Public Health ("CDPH") requires, pursuant to its August 11, 2021, Order ("Order"), that all public and private schools serving students in transitional kindergarten through grade twelve, unless exempt, are required to verify the vaccine status of all K-12 school workers, effective October 15, 2021. Further, pursuant to the Order, all such schools are required to verify that all workers are either fully vaccinated or undergo weekly diagnostic testing.

In light of these CDPH requirements, Contractor certifies that the following entity:

_____ has verified that the Contractor personnel providing services at District's Project site(s):

- Have all been fully vaccinated in accordance with the CDPH Order.

- Have not all been fully vaccinated, but those who are unvaccinated or not fully vaccinated undergo weekly diagnostic testing in accordance with the CDPH Order.

- Have not been fully vaccinated and do not undergo weekly diagnostic testing in accordance with the CDPH Order.

Contractor understands that the District's Project site will need to comply with the CDPH Order's COVID-19 requirements for fully vaccinated personnel or unvaccinated personnel. Personnel who are not fully vaccinated or decline to state their vaccination status will be treated as unvaccinated, and Contractor will comply with the CDPH Order, and all applicable state and local laws for vaccinated and unvaccinated personnel.

CERTIFICATION

I, _____, certify that I am Contractor's _____ and that I have made a diligent effort to ascertain the facts with regard to the representations made herein.

Date: _____

Proper Name of Contractor: _____

Signature: _____

Print Name: _____

Title: _____

END OF DOCUMENT

HAZARDOUS MATERIALS
PROCEDURES & REQUIREMENTS

10. Summary

This document includes information applicable to hazardous materials and hazardous waste abatement.

11. Notice of Hazardous Waste or Materials

- a. Contractor shall give notice in writing to the District, the Construction Manager, and the Architect promptly, before any of the following materials are disturbed, and in no event later than twenty-four (24) hours after first observance, of any:
 - (1) Material that Contractor believes may be a material that is hazardous waste or hazardous material, as defined in section 25117 of the Health and Safety Code, that is required to be removed to a Class I, Class II, or Class III disposal site in accordance with provisions of existing law;
 - (2) Other material that may present a substantial danger to persons or property exposed thereto in connection with Work at the site.
- b. Contractor's written notice shall indicate whether the hazardous waste or material was shown or indicated in the Contract Documents to be within the scope of Work, and whether the materials were brought to the site by Contractor, its Subcontractors, suppliers, or anyone else for whom Contractor is responsible. As used in this section the term "hazardous materials" shall include, without limitation, asbestos, lead, Polychlorinated biphenyl (PCB), petroleum and related hydrocarbons, and radioactive material.
- c. In response to Contractor's written notice, the District shall investigate the identified conditions.
- d. If the District determines that conditions do not involve hazardous materials or that no change in terms of Contract is justified, the District shall so notify Contractor in writing, stating reasons. If the District and Contractor cannot agree on whether conditions justify an adjustment in Contract Price or Contract Time, or on the extent of any adjustment, Contractor shall proceed with the Work as directed by the District.
- e. If after receipt of notice from the District, Contractor does not agree to resume Work based on a reasonable belief it is unsafe, or does not agree to resume Work under special conditions, then District may order such portion of Work that is in connection with such hazardous condition or such affected area to be deleted from the Work, or performed by others, or District may invoke its rights to terminate the Contract in whole or in part. District will determine entitlement to or the amount or extent of an adjustment, if any, in

Contract Price or Contract Time as a result of deleting such portion of Work, or performing the Work by others.

- f. If Contractor stops Work in connection with any hazardous condition and in any area affected thereby, Contractor shall immediately redeploy its workers, equipment, and materials, as necessary, to other portions of the Work to minimize delay and disruption.

12. Additional Warranties and Representations

- a. Contractor represents and warrants that it, its employees, and its subcontractors and their employees, shall at all times have the required levels of familiarity with the Site and the Work, training, and ability to comply fully with all applicable laws and contractual requirements for safe and expeditious performance of the Work, including whatever training is or may be required regarding the activities to be performed (including, but not limited to, all training required to address adequately the actual or potential dangers of Contract performance).
- b. Contractor represents and warrants that it, its employees, and its subcontractors and their employees, shall at all times have and maintain in good standing any and all certifications and licenses required by applicable federal, state, and other governmental and quasi-governmental requirements applicable to the Work.
- c. Contractor represents and warrants that it has studied carefully all requirements of the Specifications regarding procedures for demolition, hazardous waste abatement, or safety practices, specified in the Contract, and prior to submitting its bid, has either (a) verified to its satisfaction that the specified procedures are adequate and sufficient to achieve the results intended by the Contract Documents, or (b) by way of approved "or equal" request or request for clarification and written Addenda, secured changes to the specified procedures sufficient to achieve the results intended by the Contract Documents. Contractor accepts the risk that any specified procedure will result in a completed Project in full compliance with the Contract Documents.

13. Monitoring and Testing

- a. District reserves the right, in its sole discretion, to conduct air monitoring, earth monitoring, Work monitoring, and any other tests (in addition to testing required under the agreement or applicable law), to monitor Contract requirements of safe and statutorily compliant work methods and (where applicable) safe re-entry level air standards under state and federal law upon completion of the job, and compliance of the work with periodic and final inspection by public and quasi-public entities having jurisdiction.
- b. Contractor acknowledges that District has the right to perform, or cause to be performed, various activities and tests including, but not limited to, pre-abatement, during abatement, and post-abatement air monitoring, that District shall have no obligation to perform said activities and tests, and that a portion of said activities and tests may take place prior to the completion of

the Work by Contractor. In the event District elects to perform these activities and tests, Contractor shall afford District ample access to the Site and all areas of the Work as may be necessary for the performance of these activities and tests. Contractor will include the potential impact of these activities or tests by District in the Contract Price and the Scheduled Completion Date.

- c. Notwithstanding District's rights granted by this paragraph, Contractor may retain its own industrial hygiene consultant at Contractor's own expense and may collect samples and may perform tests including, but not limited to, pre-abatement, during abatement, and post-abatement personal air monitoring, and District reserves the right to request documentation of all such activities and tests performed by Contractor relating to the Work and Contractor shall immediately provide that documentation upon request.

14. Compliance with Laws

- a. Contractor shall perform safe, expeditious, and orderly work in accordance with the best practices and the highest standards in the hazardous waste abatement, removal, and disposal industry, the applicable law, and the Contract Documents, including, but not limited to, all responsibilities relating to the preparation and return of waste shipment records, all requirements of the law, delivering of all requisite notices, and obtaining all necessary governmental and quasi-governmental approvals.
- b. Contractor represents that it is familiar with and shall comply with all laws applicable to the Work or completed Work including, but not limited to, all federal, state, and local laws, statutes, standards, rules, regulations, and ordinances applicable to the Work relating to:
 - (1) The protection of the public health, welfare and environment;
 - (2) Storage, handling, or use of asbestos, PCB, lead, petroleum based products, radioactive material, or other hazardous materials;
 - (3) The generation, processing, treatment, storage, transport, disposal, destruction, or other management of asbestos, PCB, lead, petroleum, radioactive material, or hazardous waste materials or other waste materials of any kind; and
 - (4) The protection of environmentally sensitive areas such as wetlands and coastal areas.

15. Disposal

- a. Contractor has the sole responsibility for determining current waste storage, handling, transportation, and disposal regulations for the job Site and for each waste disposal facility. Contractor must comply fully at its sole cost and expense with these regulations and any applicable law. District may, but is not obligated to, require submittals with this information for it to review consistent with the Contract Documents.

- b. Contractor shall develop and implement a system acceptable to District to track hazardous waste from the Site to disposal, including appropriate "Hazardous Waste Manifests" on the EPA form, so that District may track the volume of waste it put in each landfill and receive from each landfill a certificate of receipt.
- c. Contractor shall provide District with the name and address of each waste disposal facility prior to any disposal, and District shall have the express right to reject any proposed disposal facility. Contractor shall not use any disposal facility to which District has objected. Contractor shall document actual disposal or destruction of waste at a designated facility by completing a disposal certificate or certificate of destruction forwarding the original to the District.

16. Permits

- a. Before performing any of the Work, and at such other times as may be required by applicable law, Contractor shall deliver all requisite notices and obtain the approval of all governmental and quasi-governmental authorities having jurisdiction over the Work. Contractor shall submit evidence satisfactory to District that it and any disposal facility:
 - (1) have obtained all required permits, approvals, and the like in a timely manner both prior to commencement of the Work and thereafter as and when required by applicable law; and
 - (2) are in compliance with all such permits, approvals and the regulations.

For example, before commencing any work in connection with the Work involving asbestos-containing materials, or PCBs, or other hazardous materials subject to regulation, Contractor agrees to provide the required notice of intent to renovate or demolish to the appropriate state or federal agency having jurisdiction, by certified mail, return receipt requested, or by some other method of transmittal for which a return receipt is obtained, and to send a copy of that notice to District. Contractor shall not conduct any Work involving asbestos-containing materials or PCBs unless Contractor has first confirmed that the appropriate agency having jurisdiction is in receipt of the required notification. All permits, licenses, and bonds that are required by governmental or quasi-governmental authorities, and all fees, deposits, tap fees, offsite easements, and asbestos and PCB disposal facilities expenses necessary for the prosecution of the Work, shall be procured and paid for by Contractor. Contractor shall give all notices and comply with the all applicable laws bearing on the conduct of the Work as drawn and specified. If Contractor observes or reasonably should have observed that Plans and Specifications and other Contract Documents are at variance therewith, it shall be responsible for promptly notifying District in writing of such fact. If Contractor performs any Work contrary to applicable laws, it shall bear all costs arising therefrom.

- b. In the case of any permits or notices held in District's name or of necessity to be made in District's name, District shall cooperate with Contractor in securing the permit or giving the notice, but the Contractor shall prepare for District review and execution upon approval, all necessary applications, notices, and other materials.

17. Indemnification

To the fullest extent permitted by law, the indemnities and limitations of liability expressed throughout the Contract Documents apply with equal force and effect to any claims or liabilities imposed or existing by virtue of the removal, abatement, and disposal of hazardous waste. This includes, but is not limited to, liabilities connected to the selection and use of a waste disposal facility, a waste transporter, personal injury, property damage, loss of use of property, damage to the environment or natural resources, or "disposal" and "release" of materials associated with the Work (as defined in 42 U.S.C. § 9601 *et seq.*).

18. Termination

District shall have an absolute right to terminate for default immediately without notice and without an opportunity to cure should Contractor knowingly or recklessly commit a material breach of the terms of the Contract Documents, or any applicable law, on any matter involving the exposure of persons or property to hazardous waste. However, if the breach of contract exposing persons or property to hazardous waste is due solely to an ordinary, unintentional, and non-reckless failure to exercise reasonable care, then the procedures for termination for cause shall apply without modification.

END OF DOCUMENT

Exhibit A - Site Map
(1 Page)

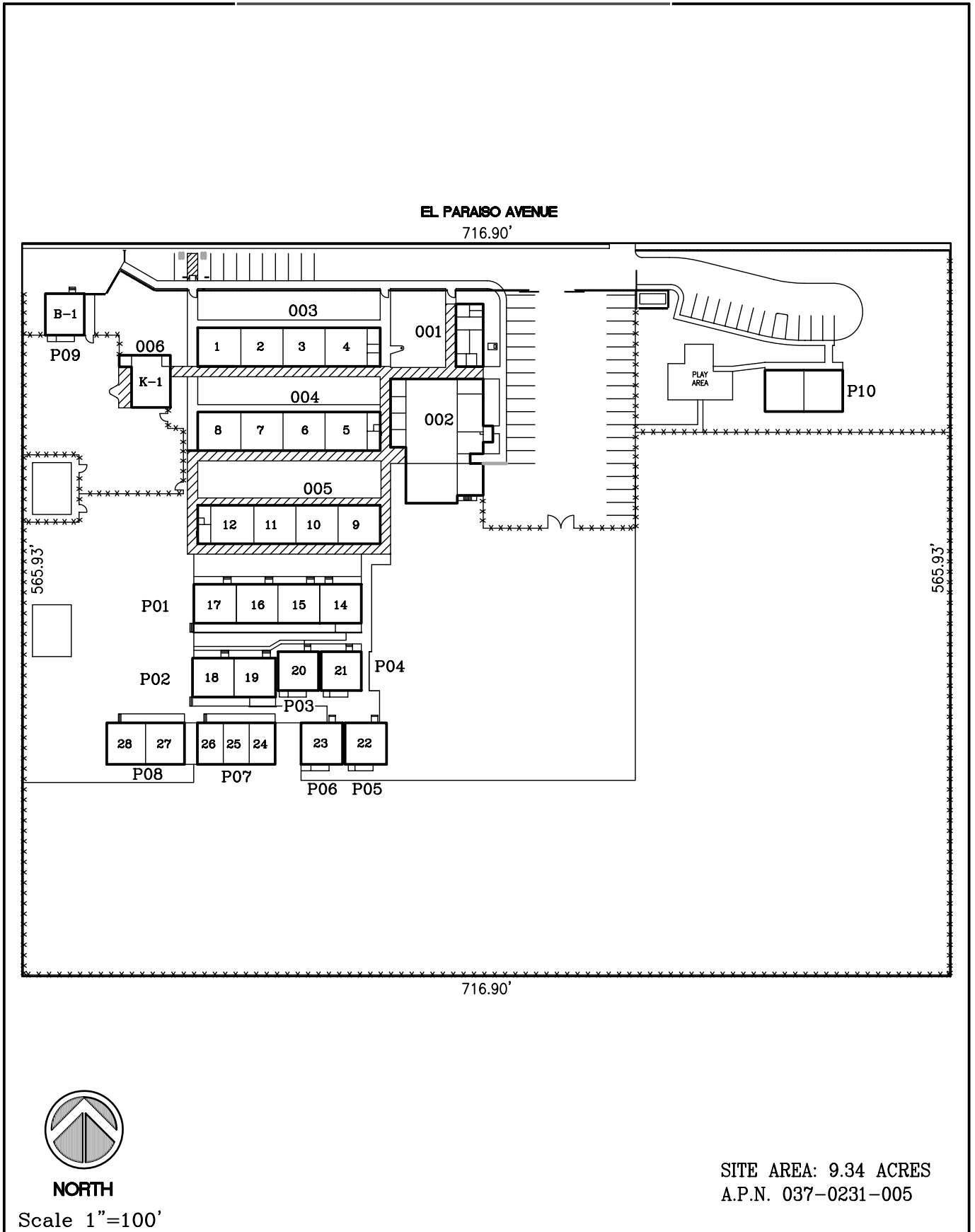

040 - Clayton B. Wire Elementary School
5100 El Paraiso Avenue
SACRAMENTO CITY UNIFIED SCHOOL DISTRICT

EXISTING SITE DIAGRAM

OCTOBER 2001

SITE AREA: 9.34 ACRES
A.P.N. 037-0231-005

Exhibit C - Asphalt Scope (1 Page)

- KEYNOTE LEGEND:**
- 1) Yellow - Crack Fill, Seal, Re-Stripe to match existing
 - 2) Blue - 2" over lay, Crack fill, Petro Matt, 6'-10' Conform grind as necessary at transitions and edges. Re-stripe play areas per existing striping.
 - 3) Green - 3" AC Remove and replace
 - 4) Raise all boxes to grade

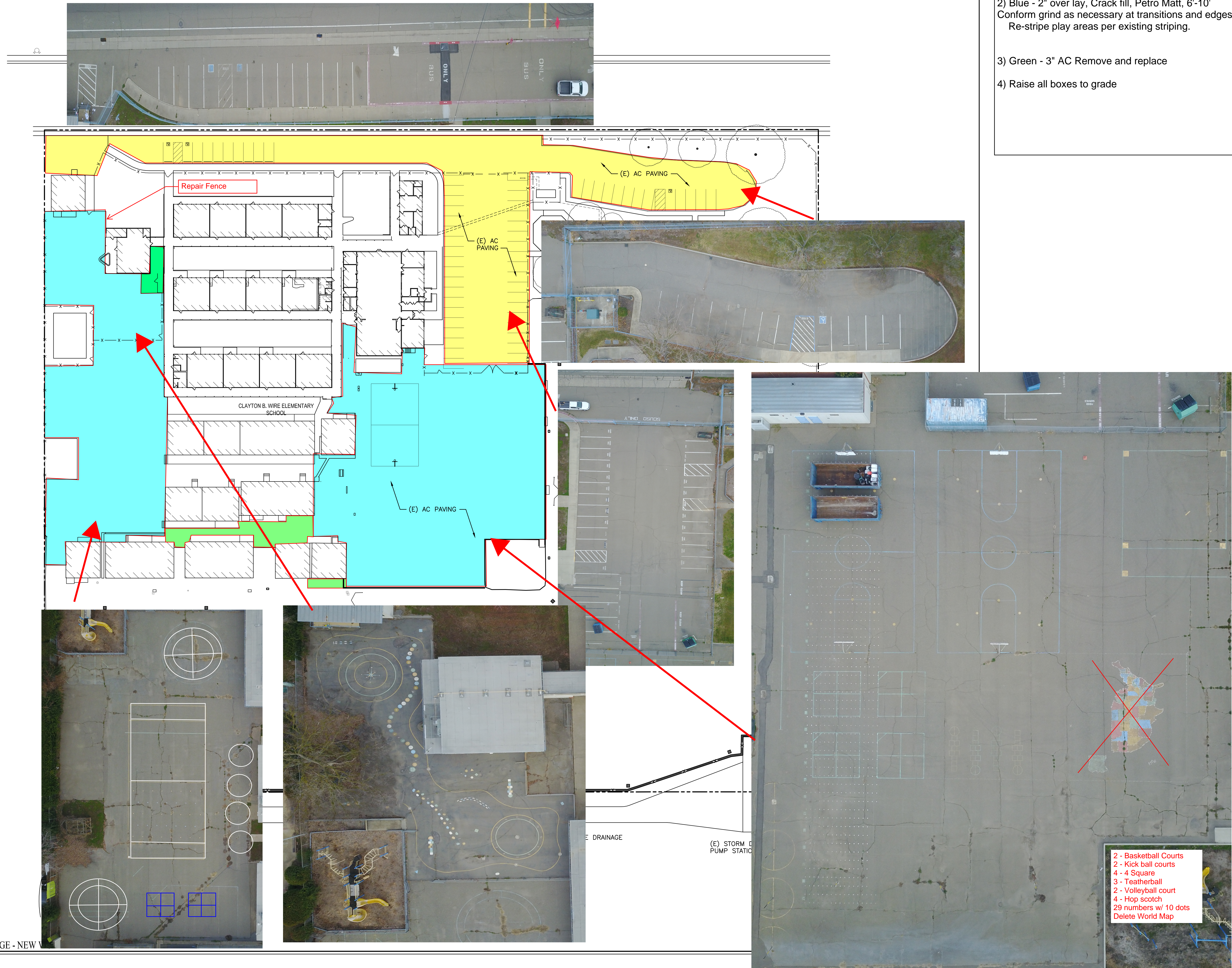

OPSC PACKAGES
0125, 0127, & 0126

**CLAYTON B. WIRE
ELEMENTARY
SCHOOL**

5100 EL PARAISO AVE.
SACRAMENTO CA 95817

SACRAMENTO CITY
UNIFIED SCHOOL
DISTRICT

BID SET

REVISIONS

NO.	DESCRIPTION	DATE

ALL DRAWINGS AND WRITTEN MATERIAL APPEARING HEREON CONSTITUTE ORIGINAL & UNPUBLISHED WORK OF HMR ARCHITECTS AND MAY NOT BE DUPLICATED, USED OR DISCLOSED WITHOUT WRITTEN CONSENT OF HMR ARCHITECTS

OVERALL SITE PLAN

MARCH 17, 2015

DRAWN BY: JIC
CHECKED BY: BF
JOB NO.: 14087

- 2 - Basketball Courts
- 2 - Kick ball courts
- 4 - 4 Square
- 3 - Teetherball
- 2 - Volleyball court
- 4 - Hop scotch
- 29 numbers w/ 10 dots
- Delete World Map

3/17/2015 3:52 PM BRYAN SACRAMENTO CITY UNIFIED SCHOOL DISTRICT PROGRAM CLAYTON B. WIRE 14087 DRAINAGE AT FIELD/A-1.2 SITE PLAN - NEW WORK AND DETAILS.DWG

Exhibit D - Roofing Scope (3 Pages)

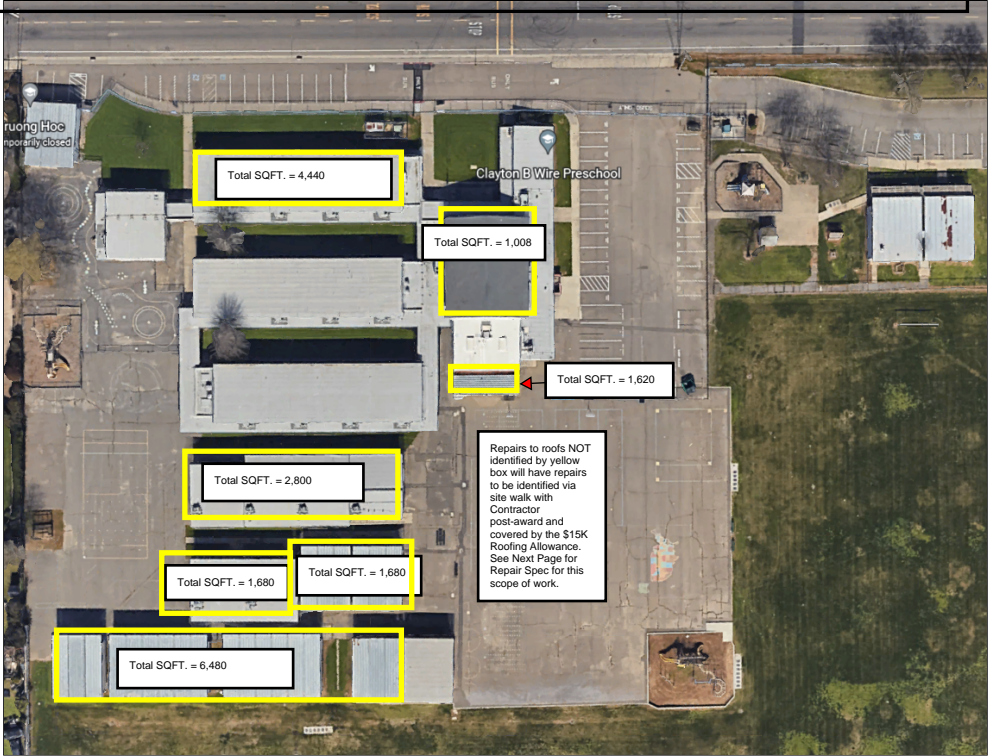

**Exhibit D – New Roofing Scope for
Buildings 003, P01, P02, P03, P04, P06, P07, P08, Rm 33**

PART 1 - GENERAL

1.1 SUMMARY:

- A. Replace existing roofs per scopes of work below.

1.2 SCOPE OF WORK:

- A. Remove existing BUR or metal roof systems to plywood deck.
- B. Gutters and downspouts will be left in place.
 - 1. Exception is P06/CR23. Metal Roof has been torn off in storm
 - a. Replace 30' of gutter on North side. Downspout is intact.
- C. Mechanically fasten one layer of ¼" coverboard.
- D. Install mechanically fastened 60-Mil TPA roof system including all associated components and flashings.
- E. New coated metal drip edge will have 4" face and be installed with a continuous cleat.
- F. Install T patches where sheets intersect.
- G. Refer to District Standard for additional installation instructions.
- H. *** NOTE: Restroom roof will not be removed. Fill flutes with flute filler insulation and install wood nailers around the entire perimeter prior to installing new roof per scope above. ***

END OF SECTION

Exhibit D -

Roofing Repairs For Buildings P09, K-1, 002 (Portion not identified as being replaced), 004, 005, P05, & P10)

PART 1 - GENERAL

1.1 SUMMARY:

- A. Repair existing roofs per scopes of work below.

1.2 SCOPE OF WORK:

A. Splits at perimeter and field of roof:

1. Thoroughly clean area to be repaired and prime with asphaltic primer.
2. Embed one 4" wide ply of fiberglass mesh into elastomeric mastic to completely cover split.
3. Embed 6" ply of fiberglass mesh into additional layer of elastomeric mastic.
4. Surface repair with white ceramic roofing granules.

B. Fasteners backing out at perimeter or in field of roof.

1. Pull fastener and replace with new heavier gauge nail.
2. Prime area with asphaltic primer.
3. Embed one 4" wide ply of fiberglass mesh into elastomeric mastic to completely cover nail(s) that were replaced.
4. Embed 6" ply of fiberglass mesh into additional layer of elastomeric mastic.
5. Surface repair with white ceramic roofing granules.

C. Open curb corners

1. Thoroughly clean area to be addressed and prime with asphaltic primer.
2. Embed one 4" wide ply of fiberglass mesh into elastomeric mastic to completely cover split.
3. Embed 6" ply of fiberglass mesh into additional layer of elastomeric mastic.
4. Surface repair with white ceramic roofing granules.

D. Pipe penetrations:

1. Thoroughly clean area around base of pipe and prime with asphaltic primer.
2. Apply elastomeric mastic around entire pipe base, extending 3" onto the roof.
3. Surface repair with white ceramic roofing granules.

E. Misc repairs:

1. Consult with construction manager for direction on other roof repairs that are not covered in the scopes above.

END OF SECTION

Exhibit E - Exterior Repairs (3 Pages)

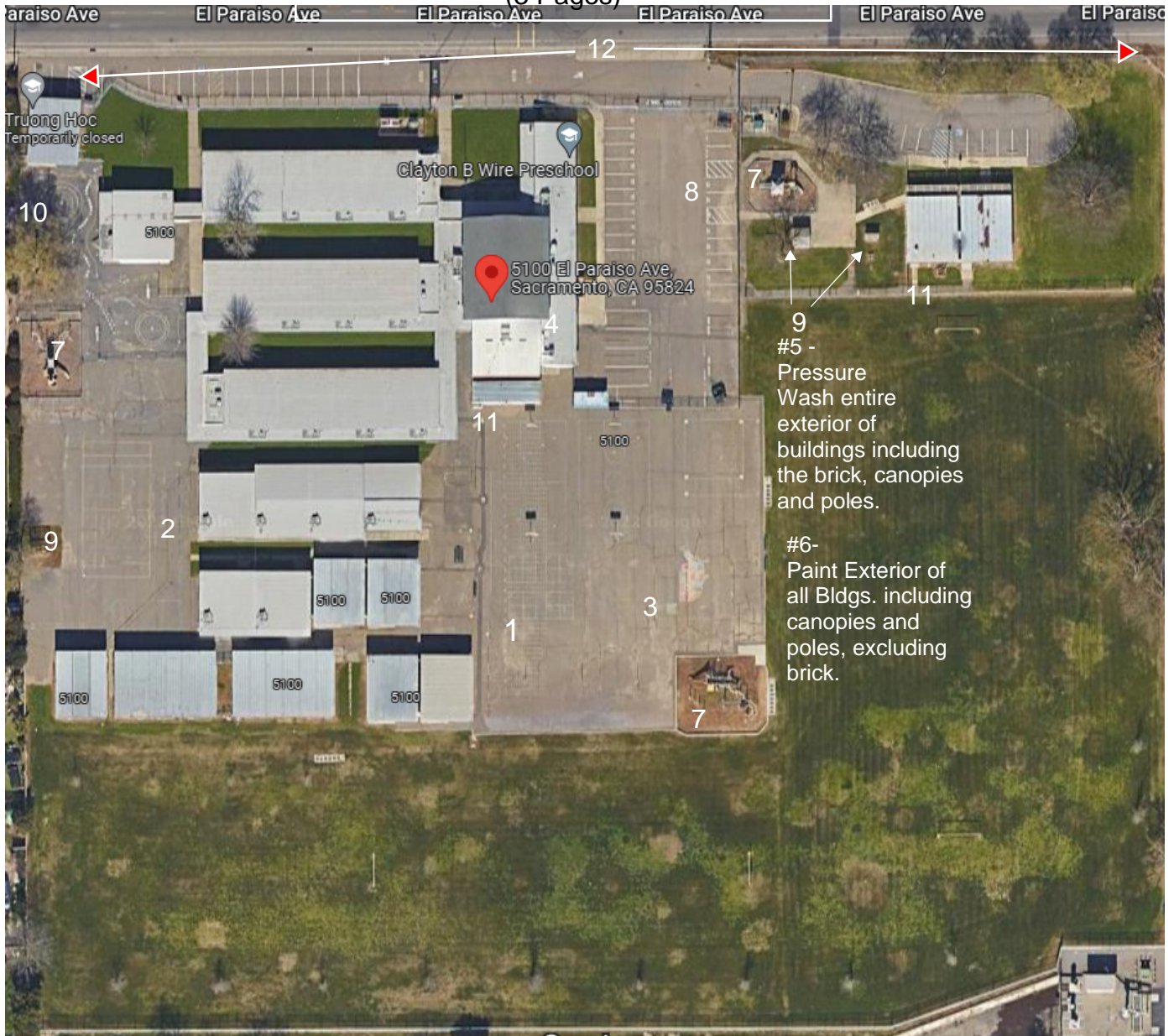

Miscellaneous Exterior		
Item	Repair Type	Comments
1	Tetherball Refresh (East) - Qty of 3	Provide & Install new Ball and Tether
2	Tetherball Refresh (West) - Qty of 4	Provide & Install new Ball and Tether
3	Volleyball Poles - Qty or 3	Remove & Provide and Install New Poles
4	Basketball Backboards and Hoops Replaced - Qty of 4	Poles to Remain, Provide & Install new Backboards, Hoops & Nets
5	Pressure Wash	Complete Exterior of all Buildings including the brick
6	Paint entire exterior of campus buildings including canopies and poles, excluding brick exterior	
7	All Play Areas - Qty of 3	Remove Existing Bark - Provide & Install New Park
8	Site signage needed (Example: ADA Parking)	Scope TBD - Covered by Owner Allowance
9	Items to Demo & Remove	Free standing structures in Pre-School Yard + West Asphalt Area
10	Vinyl Privacy Slates added at Kinder Playground existing 5' high chain-link fence	~100 LF of Privacy slates only
11	Remove Existing Drinking Fountain & Install OFCI Bottle Filler, Qty of 1, on South side of Portable Restroom Bldg and Qty of 1, on South side of P10 Pre-School Bldg.	Provide Pick-up of Units from District Location. Please See Next Page for Bottle Filler Specs.
12	Paint Ornamental Fence Black ~ 650 LF	

A172-UG-VR-BF Series

BARRIER FREE, VANDAL RESISTANT BUTTON, UNIVERSAL BI-LEVEL, WALL MOUNTED DRINKING FOUNTAIN WITH PUSHBUTTON OR SENSOR OPERATED BOTTLE FILLER

STANDARD FEATURES

Drinking Fountain

- Child or Adult Ada Compliant (When Properly Installed)
- Apron and One-Piece Bottom Wrapper is Satin Finish Or Gray Powder Coat Finish
- Flexible, Low Flow, Antimicrobial, Anti-Rotation, Non-Squirt Bubbler
- Auto-Stop Allows Cartridge And Strainer Service Without Removing Cooler Deck To Access Water Supply Stop
- Universal Bi-Level Can Be Installed Left High or Right High With No Additional Parts.
- Lead-Free
- Rough-Ins Match Other Manufacturer's for Easy Replacement

Bottle Filler

- Hands-Free Sensor Operation or Pushbutton Operated
- ADA Compliant
- 100-Mesh Inlet Strainer
- 120VAC/9.0VDC Plug-In Transformer, With -BF12 Only
- Laminar Flow Water Supply
- 1 GPM Fill Rate
- -BF12 Sensor Has a 20 Seconds Maximum Run Time

SUGGESTED SPECIFICATIONS

Drinking Fountain

Model A172108F-UG-VR-BF is a self-contained, Bi-Level Drinking Fountain. Units shall be activated by Vandal Resistant Chrome Plated Brass Front Pushbuttons by using less than 5 pounds of force. Bubbler shall deliver a 0.3 GPM flow, have an Antimicrobial Flexible Guard with an integrally designed Non-Squirt feature and operate on a water pressure range of 20-105 PSIG. Basin shall be constructed from 304 Stainless Steel and have an Integral Drain. Cabinet shall be Stainless Steel with Satin Finish or Galvanized/Galvannealed Steel with Gray Powder Coat Finish. Fountain Unit is certified to ANSI A117.1, Public Law 111-380 (NO-LEAD), CHSC 116875 and NSF/ANSI 61, Section 9. Fixture meets ADA, ADA Standing Person, and ADA Child requirements when mounted appropriately.

Bottle Filler -BF11

Bottle Filling unit shall include Pushbutton Operated activation.

Bottle Filler -BF12

Bottle Filling unit shall include Sensor Operated activation with a 20 second maximum run time. LED Lights illuminate the Bottle Fill area and brighten when a bottle is detected. Optional -BCD (Bottle Counter Display) indicates the quantity of 16 oz disposable Plastic Bottles saved from a land fill and also displays the Water Filter status.

Bottle Filler housing construction will be 20 gauge Stainless Steel with a satin finish and will also include components manufactured from Antimicrobial, impact resistant ABS. Bottle Filler shall provide approximately 1 GPM flow rate with a Laminar Flow Spout to minimize splashing.

Complies with the following standards:



NSF/ANSI 61



"RATED FOR INDOOR USE ONLY"

MODEL:
(Must Specify)

FLEXIBLE BUBBLER

- A172100F-UG-VR Gray Finish Cooler w/ Satin Finish Bottle Filler
- A172400F-UG-VR Satin Stainless Finish (Shown)

STAINLESS STEEL BUBBLER

- A172100S-UG-VR Gray Finish Cooler w/ Satin Finish Bottle Filler
- A172400S-UG-VR Satin Stainless Finish

MUST SPECIFY BOTTLE FILLER:

- BF11 Bottle Filler with Pushbutton Operation
- BF12 Bottle Filler with Sensor Operation
- BF12-BAT Bottle Filler with Battery Operated Sensor Operation (N/A With -BCD)
- BF12-BCD Bottle Filler with Sensor Operation with Bottle Counter Display

WATER COOLER OPTIONS

(additional costs may apply)

- BP8 Back Panel, Stainless Steel
- CSC6 Concealed Support Carrier
- DD Drop Down Door (with -WF1 Only)
- LOGO Customer Specified Logo / Graphics
- SK5 Skirt Kit for upper unit
- WF1 1500-Gallon Capacity, NSF 42+53, 1-Micron Lead Reduction Filter
- WF3 3000-Gallon Capacity, NSF 42+53, 1-Micron Lead Reduction Filter



Member of U.S. Green Building Council



Recyclable Product



Water Conserving Product

Accessibility Compliance is subject to local Code Enforcement Authority.

⚠ WARNING: Cancer and Reproductive Harm - www.P65Warnings.ca.gov

A172-UG-VR-BF Series

BARRIER FREE, VANDAL RESISTANT BUTTON, UNIVERSAL BI-LEVEL, WALL MOUNTED DRINKING FOUNTAIN WITH PUSHBUTTON OR SENSOR OPERATED BOTTLE FILLER

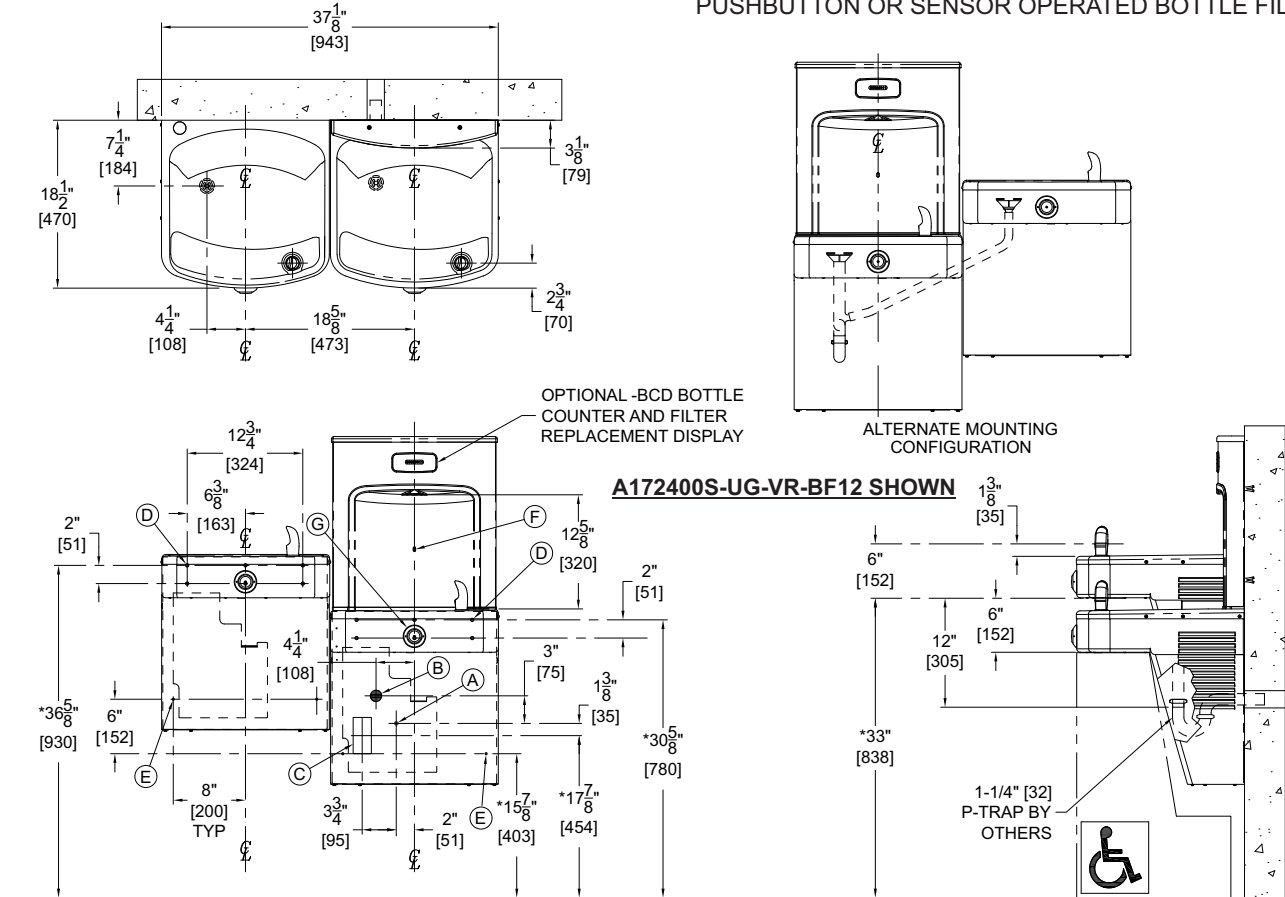

GENERAL NOTES:

1. ALL DIMENSIONS ARE IN INCHES [MM]
2. ALLOW 4 INCHES [102MM] MINIMUM CLEARANCE PER SIDE FOR VENTILATION
- *3. DIMENSIONS SHOWN ARE FOR ADA ADULT HEIGHT. ADJUST VERTICAL DIMENSIONS AS NECESSARY TO COMPLY WITH FEDERAL, STATE & LOCAL CODES
4. STOP VALVE, P-TRAP & ELECTRICAL OUTLET NOT SUPPLIED
5. IMPORTANT: COOLERS MUST BE ATTACHED TO WALL WITH APPROPRIATE ANCHOR SCREWS

- A. 3/8" O.D. SUPPLY INLET
- B. WASTE OUTLET FOR P-TRAP BY OTHERS FOR PROVIDED 1-1/4" O.D. TAILPIECE
- C. ELECTRICAL SERVICE ROUGH-IN FOR OPTIONAL -BF12 SENSOR OPERATED BOTTLE FILLER, SHOWN
- D. Ø3/8" HANGER BRACKET PUNCHING, 6 PLACES FOR ANCHORING HARDWARE BY OTHERS
- E. Ø1/4" PUNCHING, 2 PLACES FOR ANCHORING HARDWARE, BY OTHERS
- F. BOTTLE FILLER SENSOR
- G. VANDAL RESISTANT PUSHBUTTON CARTRIDGE

Murdock Mfg.™ warrants that its products are free from defects in material or workmanship under normal use and service for a period of one year from date of shipment. Murdock's liability under this warranty shall be discharged solely by replacement or repair of defective material, provided Murdock™ is notified in writing within one year from date of shipment, F.O.B. Industry, California.

SELECTION SUMMARY & APPROVAL FOR MANUFACTURING	Model Number & Options _____	Quantity _____	All dimensions are subject to manufactures tolerance of plus or minus 1/2" nominal and subject to change without notice. Murdock assumes no responsibility for use of void or superseded data. Dimensions may change with the addition of optional accessories. Murdock Mfg.™, Member of Morris Group International™. Please visit www.murdockmfg.com for most current specifications.
	Company _____		
	Contact _____	Title _____	
	Signature (Approval for Manufacturing) _____	Date _____	

Exhibit F - Assessment Sheets

44 Pages

Admin Office

~ Interior SQFT =

260

~ Interior Average Wall Height in inches =

113

Int/Ext	Repair Type	Comments
Interior	Provide and Install Fire Extinguisher w/ Wall Bracket	Multipurpose Dry Chemical w/ Wall Mount
Interior	Provide and Install New Carpet w/ Rubber Base	Walk-Off Mat @ Door 7' x 10'
Interior	Paint	Walls + Trim + Ceiling + Doors
Interior	Ceiling Tiles Reattached and Painted	
Exterior	Provide & Install Provide & Install Room Signage	Confirm Naming of Rooms - Match Existing

Admin Closet

~Interior SQFT = 49

~Interior Average Wall Height in inches = 96

Int/Ext	Repair Type	Comments
Interior	Provide & Install New Carpet w/ Rubber Base	
Interior	Paint	Walls + Trim + Ceiling (Hard Lid) + Doors

Bldg 001**Nurse Office & Restroom**~ Interior Vinyl Floor SQFT = **240**~ Interior Average Wall Height in inches = **124**

Int/Ext	Repair Type	Comments
Interior	Provide and Install Fire Extinguisher w/ Wall Bracket	Multipurpose Dry Chemical w/ Wall Mount
Interior	Provide & Install New Vinyl Floor Tile	Tarkett Silverbell Sheet Vinyl. (Spec will be provided w/ Final Addendum)
Interior	Paint	Walls + Trim + Ceiling + Doors
Interior	T-Bar Ceiling Acoustical Tiles	1 Tile Replaced, Rest Put in Place Up & Painted
Interior	Casework Painted	
Interior	Casework Repaired	Adjust Doors
Interior	Rest Room - New Vinyl Floor	Replace with New Vinyl: Tarkett Silverbell Sheet Vinyl

Bldg 001

Principal Office

~Interior SQFT = 184
~Interior Average Wall Height in inches = 153

Principal Bathroom

~Interior SQFT = 28
~Interior Wall Height in inches = 153

Int/Ext	Repair Type	Comments
Interior	Provide & Install New Carpet w/ Rubber Base	Walk-Off Mat @ Door, 5' x 5'
Interior	Paint	Walls + Trim + Case Work + Ceiling Tiles + Door
Interior	Ceiling Tiles: Replace (2), Secure Remaining & Paint	Replace 2, Secure Remaining & Paint
Interior	Casework Painted	
Interior	Restroom - Paint	Walls + Trim + Ceiling + Door

Admin - Break/Galley Kitchen

~Interior SQFT = 80
 ~Interior Average Wall Height in inches = 99
 124

Int/Ext	Repair Type	Comments
Interior	Provide and Install Fire Extinguisher w/ Bracket	Multipurpose Dry Chemical w/ Wall Mount
Interior	Provide & Install New Carpet w/ Rubber Base	Walk-Off Mat @ Door 5' x 5'
Interior	Paint	Walls + Trim + Door + Ceiling Tiles
Interior	Reattach loose ceiling tiles	
Interior	All Casework Demo'd	
Interior	3 x 5 Wood Mail Cubbie removed from wall and installed on an Admin Wall, location TBD	
Interior	Patch and Paint walls behind removed cabinets	
Interior	Cut & Cap Sewer and Water Line	
Interior	Remove Hand Soap and Paper Towel Dispensers from Wall	Save to see if needed elsewhere
Interior	Door Repair	
Interior	Signage (Qty 1)	Match Existing

MPR Kitchen Office/Storage

~Interior SQFT = 80

~Interior Average Wall Height in inches = 99

Int/Ext	Repair Type	Comments
Interior	Provide & Install New Carpet w/ Rubber Base	
Interior	Paint	Walls + Trim + Door + Ceiling (Hard Lid)
Interior	Casework Painted	
Interior	Casework Repaired	Door Adjustments Needed on cabinets outside of Office/Storage Room

MPR Kitchen

~ Interior SQFT =

500

~Interior Average Wall Height in inches =

108

Int/Ext	Repair Type	Comments
Interior	Provide and Install Fire Extinguisher w/ Bracket	Kitchen Grade FE (Spec will be provided w/ Final Addendum)
Interior	Provide & Install Vinyl Floor	Tarkett Silverbell Sheet Vinyl (Spec will be provided with final Addendum)
Interior	Paint	Walls + Trim + Ceiling Tiles + Door
Interior	Ceiling Tiles	Replace (2) , Secure as needed & Paint
Interior	Casework Painted	
Interior	Casework Repaired	Tighten Handles
Interior	Casework Reattached	Cabinet Door
Interior	Casework Removed	Remove Metal Cabinet Over the Sink

MPR Storage

~Interior SQFT = **200**

~Interior Average Wall Height in inches = **114**

Int/Ext	Repair Type	Comments
Interior	Paint	Walls + Trim + Door + Ceiling (Hard Lid)
Interior	Casework Painted	

MPR - Classroom**(East of Stage)**

~Interior SQFT =

486

~Interior Average Wall Height in inches = 110

Int/Ext	Repair Type	Comments
Interior	Provide & Install Fire Extinguisher	Multipurpose Dry Chemical w/ Wall Mount
Interior	Paint	Walls + Trim + Door
Interior	Provide & Install Carpet & Rubber Base	Interior Door, no Walk-Off Mat Needed
Interior	Provide & Install Room Signage	One Sign - Match Existing

MPR - Breakroom

~Interior SQFT = 280

~Interior Average Wall Height in inches = 110

Int/Ext	Repair Type	Comments
Interior	Provide and Install Fire Extinguisher	Multipurpose Dry Chemical w/ Wall Mount
Interior	Paint	Walls + Trim + Doors
Interior	Provide & Install Carpet & Rubber Base	Walk-off Mat at Door, 5 x 5
Exterior	Door Repair	Door Closure Repair

MPR

Interior SQFT = 2480
Stage SQFT = (In addition to main floor) 1200
~Interior Average Wall Height in inches = 240

Int/Ext	Repair Type	Comments
Interior	Provide and Install Fire Extinguisher w/ Bracket	Multipurpose Dry Chemical w/ Wall Mount
Interior	Provide and Install New Carpet w/ Rubber Base (NOT ON MAIN FLOOR. Stage Only)	Stage + Stairs next to Stage - 6 Steps
Interior	4x4 Tile Squares to be Removed by Stage Steps, Leave as Concrete (NIC)	Will be removed by HAZMAT/Demo
Interior	Paint (Main Area + Stage)	Walls + Trim + Ceiling + Doors
Interior	Ceiling (Main Area) - Smooth Texture & Paint	Ceiling Tiles and Mastic will be removed by HAZMAT Contractor (NIC)
Interior	Casework Painted (Stage)	
Interior	Stage Elevator	Confirm Operational, repair as needed. (Testing and any needed repairs will be tracked on T&M under Owner Allowance)
Interior	Ice Machine	Cut and Cap Water Lines Previously used for Ice Machine

CR 02**~Interior SQFT = 930****~Interior Average Wall Height in inches = 148**

Int/Ext	Repair Type	Comments
Interior	Provide and Install Fire Extinguisher w/ Bracket	Multipurpose Dry Chemical w/ Wall Mount
Interior	Provide and Install New Carpet w/ Rubber Base	Walk-Off Mat @ Door 5' x 5'
Interior	Ceiling Acoustical Tiles Secured	
Interior	Casework Painted	
Exterior	Provide & Install Room Signage	One New Sign - Match Existing - Match Existing
Exterior	Paint	
Interior	Paint	Walls + Trim + Ceiling Tiles + Doors

CR 03

~Interior SQFT =

930

~Interior Average Wall Height in inches =

148

Int/Ext	Repair Type	Comments
Interior	Provide and Install Fire Extinguisher w/ Bracket	Multipurpose Dry Chemical w/ Wall Mount
Interior	Provide and Install New Carpet w/ Rubber Base	Walk-Off Mat @ Door 5' x 5'
Interior	Paint	Walls + Trim + Ceiling + Doors
Interior	Ceiling Acoustical Tiles	Replace 2, Secure as needed
Interior	Casework Painted	

CR 04

~Interior SQFT = 930

~Interior Average Wall Height in inches = 148

Storage Room in CR 04

~Interior SQFT = 50

~Interior Average Wall Height in inches = 102

Int/Ext	Repair Type	Comments
Interior	Provide and Install Fire Extinguisher w/ Bracket	Multipurpose Dry Chemical w/ Wall Mount
Interior	Provide and Install New Carpet w/ Rubber Base	Walk-Off Mat @ Door 5' x 5'
Interior	Paint	Walls + Trim + Ceiling Tiles + Doors
Interior	Ceiling Acoustical Tiles	Re-Attach as Needed
Interior	Casework Painted	

CR 05 (Set-up as a Library)

~Interior SQFT = 930

~Interior Average Wall Height in inches = 148

Int/Ext	Repair Type	Comments
Interior	Provide and Install Fire Extinguisher w/ Bracket	Multipurpose Dry Chemical w/ Wall Mount
Interior	Provide and Install New Carpet w/ Rubber Base	Walk-Off Mat @ Door 5' x 5'
Interior	Paint	Walls + Trim + Ceiling Tiles + Doors (Not Casework)
Interior	Ceiling Tiles	Replace 10, Secure as needed & Paint

CR 06 (Library)**~Interior SQFT = 930****~Interior Average Wall Height in inches = 148**

Int/Ext	Repair Type	Comments
Interior	Provide and Install Fire Extinguisher w/ Bracket	Multipurpose Dry Chemical w/ Wall Mount
Exterior	Provide & Install Room Signage	One New Sign - Match Existing
Interior	Provide and Install New Carpet w/ Rubber Base	Walk-Off Mat @ Door 5' x 5'
Interior	Paint	Walls + Trim (Not Tackable Surface and Not Ceiling Tiles) + Doors

CR 07

~Interior SQFT = 930

~Interior Average Wall Height in inches = 148

Int/Ext	Repair Type	Comments
Exterior	Provide & Install Room Signage	One New Sign - Match Existing
Interior	Provide and Install New Carpet w/ Rubber Base	Walk-Off Mat @ Door 5' x 5'
Interior	Paint	Walls + Trim (Not Tackable Surface and Not Ceiling Tiles) + Doors

CR 08

~Interior SQFT =

930

~Interior Average Wall Height in inches =

148

Int/Ext	Repair Type	Comments
Interior	Provide and Install Fire Extinguisher w/ Bracket	Multipurpose Dry Chemical w/ Wall Mount
Interior	Provide and Install New Carpet w/ Rubber Base	Walk-Off Mat @ Door 5' x 5'
Interior	Paint	Walls + Trim (Not Tackable Surface and Not Ceiling Tiles) + Doors
Interior	Ceiling Tiles	Secure Tiles as Needed
Exterior	Door Repair	1 Door - Weather Strip Replaced
Exterior	Provide & Install Room Signage	One New Sign - Match Existing

CR 09**~Interior SQFT = 930****~Interior Average Wall Height in inches = 148**

Int/Ext	Repair Type	Comments
Interior	Paint	Walls + Trim + Ceiling Tiles + Doors
Interior	Ceiling Tiles	5 Replaced, Secure as Needed
Interior	Casework Painted	(Currently Not Painted)
Exterior	Provide & Install Room Signage	One New Sign - Match Existing
Interior	Provide and Install Fire Extinguisher w/ Bracket	Multipurpose Dry Chemical w/ Wall Mount

CR 10**~Interior SQFT = 930****~Interior Average Wall Height in inches = 148**

Int/Ext	Repair Type	Comments
Interior	Provide and Install Fire Extinguisher w/ Bracket	Multipurpose Dry Chemical w/ Wall Mount
Interior	Provide and Install New Carpet w/ Rubber Base	Walk-Off Mat @ Door 5' x 5'
Interior	Paint	Walls + Trim + Ceiling Tiles + Doors
Interior	Ceiling Tiles	Secure as Needed
Interior	Casework Painted	
Interior	Casework Repaired	
Exterior	Door Repair	North side door needs to be repaired
Exterior	Provide & Install Room Signage	One New Sign - Match Existing

CR 11**~Interior SQFT = 930****~Interior Average Wall Height in inches = 148**

Int/Ext	Repair Type	Comments
Interior	Provide and Install Fire Extinguisher w/ Bracket	Multipurpose Dry Chemical w/ Wall Mount
Interior	Provide and Install New Carpet w/ Rubber Base	Walk-Off Mat @ Door 5' x 5'
Interior	Paint	Walls + Trim + Ceiling Tiles + Doors
Interior	Ceiling Tiles Re-Attach as Needed	
Interior	Casework Painted	
Exterior	Provide & Install Room Signage	One New Sign - Match Existing

CR 12**~Interior SQFT = 930****~Interior Average Wall Height in inches = 148**

Int/Ext	Repair Type	Comments
Interior	Provide and Install Fire Extinguisher w/ Bracket	Multipurpose Dry Chemical w/ Wall Mount
Interior	Provide and Install New Carpet w/ Rubber Base	Walk-Off Mat @ Door 5' x 5'
Interior	Paint	Walls + Trim + Ceiling Tiles + Doors
Interior	Ceiling Tiles	1 Replace = Re-Attach as Needed
Interior	Casework Painted	
Exterior	Provide & Install Room Signage	One New Sign - Match Existing

CR 13 - B1

~Interior SQFT =

870

~Interior Average Wall Height in inches =

101

Int/Ext	Repair Type	Comments
Interior	Provide and Install Fire Extinguisher w/ Bracket	Multipurpose Dry Chemical w/ Wall Mount
Interior	Provide and Install New Carpet w/ Rubber Base	Walk-Off Mat @ Door 5' x 5'
Interior	Paint	Walls + Trim + Doors
Interior	Install New Blinds	Replace (4)
Exterior	Dry Rot	Dry Rot on Roof Soffit 2'x4' Area
Exterior	Provide & Install Room Signage	One New Sign - Match Existing
Exterior	Ramps/Stairs Repaired	Replace Plywood on (2) Ramps
Interior	White Board	To Be added By M&O (NIC)

CR 14

~Interior SQFT =

960

~Interior Average Wall Height in inches =

122

Int/Ext	Repair Type	Comments
Interior	Provide and Install Fire Extinguisher w/ Bracket	Multipurpose Dry Chemical w/ Wall Mount
Interior	Provide and Install New Carpet w/ Rubber Base	Walk-Off Mat @ Door 5' x 5'
Interior	Paint	Walls + Trim + Ceiling Tiles + Doors
Interior	Interior Electrical Panel Repair Work	Panel Used as the Light Switch for Room - Provide and Install New Light Switch and New Panel Door
Interior	Ceiling Tiles	Replace 1, Secure as Needed
Interior	Demo Restroom	Remove walls, ceiling & fixtures. Cut & Cap all lines. Patch-back walls. Remove Exhaust Fan and Light Fixture, and paint with rest of room. (FA device will be relocated in Technology Project. NIC)
Interior	Casework Painted	
Interior	Casework Repaired	Handles
Exterior	Dry Rot	NE Corner Trim Replacement
Exterior	Provide & Install Room Signage	One New Sign - Match Existing

CR 15

~Interior SQFT =

960

~Interior Average Wall Height in inches =

122

Int/Ext	Repair Type	Comments
Interior	Provide and Install Fire Extinguisher w/ Bracket	Multipurpose Dry Chemical w/ Wall Mount
Interior	Provide and Install New Carpet w/ Rubber Base	Walk-Off Mat @ Door 5' x 5'
Interior	Paint	Walls + Trim + New Ceiling + Doors
Interior	Ceiling Tiles & Light Fixtures will already be removed by HAZMAT Contractor. (NIC)	
Interior	Provide & Install New T-Bar Grid & 2x4 Acoustical Tiles	Ceiling removed previously, no demo needed
Interior	Provide & Install New 2x4 LED Light Fixtures into new T-Bar grid. Quantity of 12 Fixtures	
Interior	Provide & Install Insulation above Ceiling Tile	
Interior	FA Devices currently on ceiling will be relocated by separate Technology Project (NIC)	
Interior	Floor Dry Rot	Replace 4 sheets of 4x8 floor plywood
Interior	Demo Restroom	Remove walls, ceiling & fixtures. Cut & Cap all lines. Patch-back walls. Remove Exhaust Fan and Light Fixture, and paint with rest of room. (FA device will be relocated in Technology Project. NIC)
Interior	Casework Painted	
Interior	Casework Repaired	Repair Countertops (See Photo)
Interior	Roof Substrate Repair	(See Photo)
Exterior	Wall Dry Rot	Dry Rot at Side of Window, Replace Rotted Roof Sheeting (See Photo)
Exterior	Open Electrical Conduit with Exposed Wires	Remove and Cap (See Photo)
Exterior	Provide & Install Room Signage	One New Sign - Match Existing

CR 15 Photos



Repair Countertops



Roof Substrate Repair



Dry Rot at Side of Window



Open Electrical Conduit with Exposed Wires

CR 16~Interior SQFT = **960**~Interior Average Wall Height in inches = **122**

Int/Ext	Repair Type	Comments
Interior	Provide and Install Fire Extinguisher w/ Bracket	Multipurpose Dry Chemical w/ Wall Mount
Interior	Provide and Install New Carpet w/ Rubber Base	Walk-Off Mat @ Door 5' x 5'
Interior	Paint	Walls + Trim + Ceiling + Doors
Interior	Ceiling Tiles & Light Fixtures will already be removed by HAZMAT Contractor. (NIC)	
Interior	Provide & Install New T-Bar Grid & 2x4 Acoustical Tiles	Ceiling has been removed, no demo needed
Interior	Provide & Install New 2x4 LED Light Fixtures into new T-Bar grid. Quantity of 12 Fixtures	
Interior	Provide & Install Insulation above Ceiling Tile	
Interior	FA Devices currently on ceiling will be relocated by separate Technology Project (NIC)	
Interior	Casework Painted	
Exterior	Provide & Install Room Signage	One New Sign - Match Existing

CR 17**~Interior SQFT = 960****~Interior Average Wall Height in inches = 122**

Int/Ext	Repair Type	Comments
Interior	Provide and Install Fire Extinguisher w/ Bracket	Multipurpose Dry Chemical w/ Wall Mount
Interior	Provide and Install New Carpet w/ Rubber Base	Walk-Off Mat @ Door 5' x 5'
Interior	Paint	Walls + Trim + Ceiling + Doors
Interior	Casework Painted	
Interior	Casework Repaired	Edge of Countertop
Exterior	Door Replacement	2 Wood Doors Replaced with District Specified Metal Doors. (Door Hardware OFOI NIC)
Exterior	Provide & Install Room Signage	One New Sign - Match Existing

CR 18**~Interior SQFT = 784****~Interior Average Wall Height in inches = 122**

Int/Ext	Repair Type	Comments
Interior	Provide and Install Fire Extinguisher w/ Bracket	Multipurpose Dry Chemical w/ Wall Mount
Interior	Provide and Install New Carpet w/ Rubber Base	Walk-Off Mat @ Door 5' x 5'
Interior	Paint	Walls + Trim + Ceiling + Doors
Interior	Ceiling Tiles	Re-Attached as Needed
Interior	Casework Painted	
Interior	Casework Repaired	2 Handles Needed
Interior	Drapes	Remove
Exterior	Provide & Install Room Signage	One New Sign - Match Existing

CR 19**~Interior SQFT = 784****~Interior Average Wall Height in inches = 122**

Int/Ext	Repair Type	Comments
Interior	Provide and Install Fire Extinguisher w/ Bracket	Multipurpose Dry Chemical w/ Wall Mount
Interior	Provide and Install New Carpet w/ Rubber Base	Walk-Off Mat @ Door 5' x 5'
Interior	Paint	Walls + Trim + Ceiling + Doors
Interior	Ceiling Tiles	Replace 4 + Secure As Needed
Interior	Casework Painted	
Interior	Casework Repaired	Replace Missing Handle
Interior	Drapes	Remove
Exterior	Dry Rot	10' x 10' Area + Mod Seam Facia
Exterior	Provide & Install Room Signage	One New Sign - Match Existing

CR 20

~Interior SQFT = **900**

~Interior Average Wall Height in inches = **122**

Int/Ext	Repair Type	Comments
Interior	Provide and Install Fire Extinguisher w/ Bracket	Multipurpose Dry Chemical w/ Wall Mour
Interior	Provide and Install New Carpet w/ Rubber Base	Walk-Off Mat @ Door 5' x 5'
Interior	Paint	Walls + Trim + Doors
Interior	Ceiling Acoustical 2 x 4 Tiles	Replace All Ceiling Tiles
Exterior	Provide & Install Room Signage	One New Sign - Match Existing

CR 21

~Interior SQFT = **900**

~Interior Average Wall Height in inches = **122**

Int/Ext	Repair Type	Comments
Interior	Provide and Install Fire Extinguisher w/ Bracket	Multipurpose Dry Chemical w/ Wall Mount
Interior	Provide and Install New Carpet w/ Rubber Base	Walk-Off Mat @ Door 5' x 5'
Interior	Paint	Walls + Trim + Doors
Interior	Ceiling Acoustical 2 x 4 Tiles	Replace All Ceiling Tiles
Exterior	Door Replaced	1 Door Replaced with District Specified Metal Door. (Door Hardware OFOI NIC)
Exterior	Provide & Install Room Signage	One New Sign - Match Existing





Plywood Replaced on 1 Ramp & 1 Stairs

CR 22**~Interior SQFT = 960****~Interior Average Wall Height in inches = 96**

Int/Ext	Repair Type	Comments
Interior	Provide and Install Fire Extinguisher w/ Bracket	Multipurpose Dry Chemical w/ Wall Mount
Interior	Provide and Install New Carpet w/ Rubber Base	Walk-Off Mat @ Door 5' x 5'
Interior	Paint	Walls + Trim + Doors
Interior	Ceiling Acoustical 2 x 4 Tiles	Replace 1 Tile
Interior	Shelving Painted	18' x 6' of shelving (Not casework)
Interior	Shelving Reattached	18' x 6'
Exterior	Door Replaced	1 Door Replaced with District Specified Metal Door. (Door Hardware OFOI NIC)
Exterior	Wall Dry Rot	Hole Above Door, infill (See Photo)
Exterior	Electrical Repair	Install Cap on Electrical Conduit (See Photo)
Exterior	Provide & Install Room Signage	One New Sign - Match Existing
Exterior	Ramps/Stairs Repaired	Replace Plywood at Front & Back Doors (See Photos)
Exterior	Add Exterior LED Light at Back of Classroom	Match Other RABs on Campus - Spec to be provided for RAB Fixture

CR 23

~Interior SQFT = 960

~Interior Average Wall Height in inches = 96

Int/Ext	Repair Type	Comments
Interior	Provide and Install Fire Extinguisher w/ Bracket	Multipurpose Dry Chemical w/ Wall Mount
Interior	Provide and Install New Carpet w/ Rubber Base	Walk-Off Mat @ Door 5' x 5'
Interior	Paint	Walls + Trim + Doors
Interior	Ceiling Acoustical 2 x 4 Tiles	Remove and Replace all 2 x 4 Tiles
Interior	Floor Dry Rot	Southwest corner (See Photo)
Interior	Casework Painted	6'x6' case work
Interior	Casework Reattached	6'x6' case work
Interior	Interior of Classroom has suffered extensive water damage from roof being torn off in a storm. The HAZMAT Contractor will remove all tackable surfaces, white boards, drywall and any other associated dry rot or damaged material down to studs, prior to work under this Project	HAZMAT Contractor will be asked to save cabinets for reinstall under this contract
Interior	Water Damage Repair under this contract: Provide and Install New Acoustical Ceiling Tiles, 2 x 4 LED Light Fixtures (Qty 12), above T-Bar Insulation, Drywall & Tackable Surfaces & Reinstall Existing Cabinet. (~ 24' of cabinets)	
Exterior	Door Replaced	1 Door Replaced with District Specified Metal Door. (Door Hardware OFOI NIC)
Exterior	Wall Dry Rot	Dry Rot at SW Trim & Corner (See Photo)
Exterior	Provide & Install Room Signage	One New Sign - Match Existing
Exterior	Ramps/Stairs Repaired	Plywood Replaced on (1) ramp and (1) stairs (See Photo)

CR 24

Interior SQFT = 600
~Interior Average Wall Height in inches = 96

Int/Ext	Repair Type	Comments
Interior	Provide and Install Fire Extinguisher w/ Bracket	Multipurpose Dry Chemical w/ Wall Mount
Interior	Provide and Install New Carpet w/ Rubber Base	Walk-Off Mat @ Door 5' x 5'
Interior	Paint	Walls + Trim + Doors
Interior	Modular Seam Trim Reattached - 30'	
Exterior	Door Replaced	1 Door Replaced with District Specified Metal Door. (Door Hardware OFOI NIC)
Exterior	Wall Dry Rot	See Notes for Bldg P07 on CR 26

CR 25

Interior SQFT = **600**

Interior Average Wall Height in inches = **96**

Int/Ext	Repair Type	Comments
Interior	Provide and Install Fire Extinguisher w/ Bracket	Multipurpose Dry Chemical w/ Wall Mount
Interior	Provide and Install New Carpet w/ Rubber Base	Walk-Off Mat @ Door 5' x 5'
Interior	Paint	Walls + Trim + Doors
Exterior	Wall Dry Rot	See Notes for Bldg P07 on CR 26

CR 26

Interior SQFT = **600**

Interior Average Wall Height in inches = **96**

Int/Ext	Repair Type	Comments
Interior	Provide and Install Fire Extinguisher w/ Bracket	Multipurpose Dry Chemical w/ Wall Mount
Interior	Provide and Install New Carpet w/ Rubber Base	Walk-Off Mat @ Door 5' x 5'
Interior	Paint	Walls + Trim + Doors
Interior	Light Fixtures Repaired	Add 2 x 4 lenses (10 Fixtures)
Exterior	Wall Dry Rot	Remove & Replace Siding: West Side 100 SQ FT. East Side 60 SQFT at bottom. South Side 120 SQFT. 45 SQFT at top. Remove & Replace S/W corner Trim.

CR 27

~Interior SQFT =

960

~Interior Average Wall Height in inches =

96

Int/Ext	Repair Type	Comments
Interior	Provide and Install Fire Extinguisher w/ Bracket	Multipurpose Dry Chemical w/ Wall Mount
Interior	Provide and Install New Carpet w/ Rubber Base	Walk-Off Mat @ Door 5' x 5'
Interior	Paint	Walls + Trim + Doors
Interior	Reattach Mod Seam Trim	
Exterior	Wall Dry Rot	Remove and Replace Skirting: East Side 12 SQFT. South Side 60 SQFT. Remove and Replace Trim: South East Corner
Interior	Ceiling Treated and Painted	Asbestos Tiles Removed By HAZMAT Contractor (NIC)

CR 28

-Interior SQFT =

960

-Interior Average Wall Height in inches =

96

Int/Ext	Repair Type	Comments
Interior	Provide and Install Fire Extinguisher w/ Bracket	Multipurpose Dry Chemical w/ Wall Mount
Interior	Provide and Install New Carpet w/ Rubber Base	Walk-Off Mat @ Door 5' x 5'
Interior	Paint	Walls + Trim + Doors
Interior	Reattach Mod Seam Trim	
Exterior	Wall Dry Rot	Remove & Replace NW Corner Trim. Remove & Replace 60 SQFT of Skirt Siding with 2 Vents.
Exterior	Provide & Install Room Signage	One New Sign - Match Existing

CR 33

~Interior SQFT =

960

~Interior Average Wall Height in inches =

96

Int/Ext	Repair Type	Comments
Interior	Provide and Install Fire Extinguisher w/ Bracket	Multipurpose Dry Chemical w/ Wall Mount
Interior	Tackable Surface	Remove and Replace 8x8 Section
Interior	Provide and Install New Carpet w/ Rubber Base	Walk-Off Mat @ Door 5' x 5'
Interior	Paint	Walls + Trim + Doors
Interior	Electrical Outlet Repair	Repair - Falling off Wall
Interior	Ceiling Acoustical 2 x 4 Tiles	Remove and Replace all Tiles
Exterior	Door Replaced	1 Door Replaced with District Specified Metal Door. (Door Hardware OFOI NIC)
Exterior	Wall Dry Rot	Remove and Replace: South Side 300 SQFT & East Side 60 SQFT
Exterior	Provide & Install Room Signage	One New Sign - Match Existing

CR K1

~Interior SQFT = 900

~Interior Average Wall Height in inch 147

Rest Room

~Interior SQFT = 45

~Interior Wall Height = 120

Int/Ext	Repair Type	Comments
Interior	Paint	Walls + Trim + Ceiling + Doors
Interior	Ceiling Tiles	Replace 1- Re-Attach as Needed
Interior	New Restroom Vinyl Flooring	Tarkett Silverbell Sheet Vinyl. (Spec will be provided w/ Final Addendum)
Interior	Casework Painted	
Exterior	Door Repair	Weather strip needed (2) doors
Exterior	Provide & Install Room Signage	One New Sign - Match Existing
Exterior	Paint	

Preschool

~Interior Carpet SQFT = 1215
~Interior Vinyl SQFT = 705
~Interior Average Wall Height in inches = 96

Int/Ext	Repair Type	Comments
Interior	Provide and Install Fire Extinguisher w/ Bracket	Multipurpose Dry Chemical w/ Wall Mount
Interior	Provide and Install New Carpet w/ Rubber Base	Walk-Off Mat @ (3) Doors, Each 5' x 5'
Interior	Provide and Install New Sheet Vinyl in both Restrooms & IT Server Room	Tarkett Silverbell Sheet Vinyl. (Spec will be provided w/ Final Addendum)
Interior	Paint	Walls + Trim + Doors + Doors
Interior	Ceiling Acoustical 2 x 4 Tiles	Replace (20) Ceiling Tiles
Exterior	Wall Dry Rot	Remove & Replace: Entire East Side Paneling & Trim: 341 SQFT. Remove & Replace: South Side 204 SQFT. Remove & Replace: West Side 32 SQFT. Remove & Replace: Skirting Entire Building ~240 SQFT.
Exterior	Ramps/Stairs Repaired	Replace Plywood.

Portable Restroom - Boys & Girls

Not Shown on Site Plan

~ Exterior Bldg SQFT = 600

~Interior Average Wall Height in inches = 120

Repair Type	Comments
Provide & Install Flooring Substrate - Assumed Plywood	Removal of Substrate (NIC)
Provide & Provide & Install Vinyl Flooring	Tarkett Silverbell Sheet Vinyl. (Spec will be provided w/ Final Addendum)
Provide & Install FRP	Replace (1) 4x8 FRP Section
Provide & Install New Partitions	Removal of Partitions (NIC)
Provide & Install New Ceiling Tiles	Removal of Ceiling Tiles (NIC)
Paint Ceiling Grid	Paint Grid
Exterior Door - Remove, Provide & Install New Metal Door	
Provide & Install New Ceiling Tiles	Removal of Ceiling Tiles (NIC)
Paint Ceiling Grid	Paint Ceiling Grid
Provide & Provide & Install Vinyl Flooring	Tarkett Silverbell Sheet Vinyl. (Spec will be provided w/ Final Addendum)
Provide & Install New Partitions	Removal of Partitions (NIC)

Permanent Restrooms (4)

Repair Type	Comments
Paint	Walls (Including Tiles) + Ceiling (Hard Lids) Color TBD
Deep Clean	

Exhibit G - Technology Demo Scope
(4 Pages)



5433 El Camino Ave., Suite 5
Carmichael, CA 95608
Phone 916.359.4000 - Fax: 916.520.3831

**Sacramento City USD - Clayton B. Wire
Wire/Cable, Equipment and Pathway Removal**

Scope of work:

1. To remove and dispose of properly all non-active wires and/or cables see **SCUSD_CB_Wire_Demo_Tag_List_KMM_2022-12-22.xls** spreadsheet for demo tag ID and locations.
2. To remove and dispose of properly all non-active equipment site wide.
3. To remove and dispose of properly all non-active pathways (conduit/surface raceway) site wide.
4. To preserve and keep active Fire Alarm telephone connection.
5. To preserve and keep active Intrusion Alarm telephone connection.
6. To preserve and keep active all fiber connections and data switches that support CCTV cameras.
7. To preserve and keep active the HVAC controller data connection in admin building.
8. Demo tag samples below.



Sample 1
Location: MDF

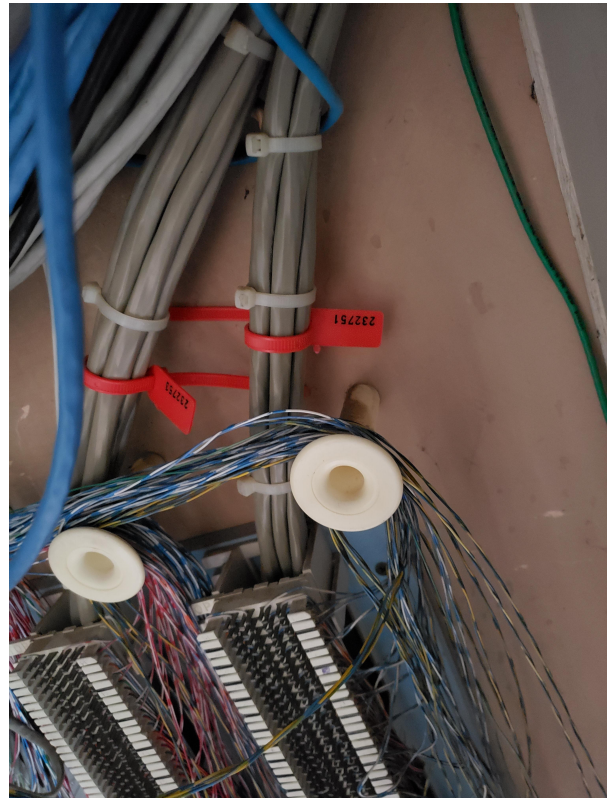

Sample 2
Location: MDF

Wire/Cable, Equipment and Pathway Removal

<u>Date Inspected</u>	<u>Location</u>	<u>Equipment/Wires to Demo</u>	<u>Tag Number</u>	<u>Pic File Name</u>	<u>Removed By</u>	<u>Date Removed</u>
12/22/2022	B-1	Clock, Speaker, Data Jacks, Wire/Pathway, Telephone	232757			
12/22/2022	B-1	Data Wire (x2)	232756			
12/22/2022	Classroom 1	Clock, Speaker, Data Jacks, Wire/Pathway, Telephone	No Tag			
12/22/2022	Classroom 10	Clock, Speaker, Data Jacks, Wire/Pathway, Telephone	No Tag			
12/22/2022	Classroom 11	Clock, Speaker, Data Jacks, Wire/Pathway, Telephone	No Tag			
12/22/2022	Classroom 12	Clock, Speaker, Data Jacks, Wire/Pathway, Telephone	No Tag			
12/22/2022	Classroom 14	Clock, Speaker, Data Jacks, Wire/Pathway, Telephone	No Tag			
12/22/2022	Classroom 15	Clock, Speaker, Data Jacks, Wire/Pathway, Telephone	No Tag			
12/22/2022	Classroom 16	Clock, Speaker, Data Jacks, Wire/Pathway, Telephone	No Tag			
12/22/2022	Classroom 17	Clock, Speaker, Data Jacks, Wire/Pathway, Telephone	No Tag			
12/22/2022	Classroom 17	Data Wire	233317			
12/22/2022	Classroom 18	Clock, Speaker, Data Jacks, Wire/Pathway, Telephone	No Tag			
12/22/2022	Classroom 19	Clock, Speaker, Data Jacks, Wire/Pathway, Telephone	No Tag			
12/22/2022	Classroom 2	Clock, Speaker, Data Jacks, Wire/Pathway, Telephone	No Tag			
12/22/2022	Classroom 20	Clock, Speaker, Data Jacks, Wire/Pathway, Telephone	No Tag			
12/22/2022	Classroom 21	Clock, Speaker, Data Jacks, Wire/Pathway, Telephone	No Tag			
12/22/2022	Classroom 22	IDF in classroom	233314			
12/22/2022	Classroom 22	Speaker, Telephone, Data Jacks, Raceway	233313			
12/22/2022	Classroom 23	Speaker, Telephone, Data Jacks, Raceway	No Tag			
12/22/2022	Classroom 24	Speaker, Telephone, Data Jacks, Raceway	No Tag			
12/22/2022	Classroom 25	Speaker, Telephone, Data Jacks, Raceway, Data Cables	No Tag			
12/22/2022	Classroom 26	Speaker, Telephone, Data Jacks, Raceway	No Tag			
12/22/2022	Classroom 26	Data Cables	233316			
12/22/2022	Classroom 27	Speaker, Telephone, Data Jacks, Raceway	No Tag			
12/22/2022	Classroom 28	Speaker, Telephone, Data Jacks, Raceway	No Tag			
12/22/2022	Classroom 3	Clock, Speaker, Data Jacks, Wire/Pathway, Telephone	No Tag			
12/22/2022	Classroom 33	Speaker, Telephone, Data Jacks, Raceway	No Tag			
12/22/2022	Classroom 4	Clock, Speaker, Data Jacks, Wire/Pathway, Telephone	No Tag			
12/22/2022	Classroom 5	Clock, Speaker, Data Jacks, Wire/Pathway, Telephone	No Tag			

Wire/Cable, Equipment and Pathway Removal

<u>Date Inspected</u>	<u>Location</u>	<u>Equipment/Wires to Demo</u>	<u>Tag Number</u>	<u>Pic File Name</u>	<u>Removed By</u>	<u>Date Removed</u>
12/22/2022	Classroom 6	Clock, Speaker, Data Jacks, Wire/Pathway, Telephone	No Tag			
12/22/2022	Classroom 7	Clock, Speaker, Data Jacks, Wire/Pathway, Telephone	No Tag			
12/22/2022	Classroom 8	Clock, Speaker, Data Jacks, Wire/Pathway, Telephone	No Tag			
12/22/2022	Classroom 8	AV/TV/Projector Mount	232781			
12/22/2022	Classroom 9	Clock, Speaker, Data Jacks, Wire/Pathway, Telephone	232784			
12/22/2022	Classroom 9	Data Cables	232752			
12/22/2022	Hallway By Admin	Cable	232790			
12/22/2022	Kindergarten Portables	Office Closet, IDF	233379			
12/22/2022	Kindergarten Portables	Data Wire	233312			
12/22/2022	Kindergarten Portables	Data Wire	233313			
12/22/2022	Kindergarten/Near Entry	Clock, Speaker, Data Jacks, Wire/Pathway, Telephone	232782			
12/22/2022	Kindergarten/Near Entry	Telephone	232797			
12/22/2022	MDF Room	Cortelco Equipment Cable	232795			
12/22/2022	MDF Room	Cortelco Equipment Cable	232800			
12/22/2022	MDF Room	Cortelco Equipment Cable	232796			
12/22/2022	MDF Room	Cortelco Equipment Cable	232798			
12/22/2022	MDF Room	Cortelco Equipment Cable	232793			
12/22/2022	MDF Room	Cortelco Equipment Cable	232791			
12/22/2022	MDF Room	PAC Bell High Cap 66	232794			
12/22/2022	MDF Room	Intercom Feeder	232753			
12/22/2022	MDF Room	Telco Wire Bundle	232758			
12/22/2022	MDF Room	Coax Cable	232754			
12/22/2022	MDF Room	Data Cables	232785			
12/22/2022	MDF Room	Data/Telco Cables	232759			
12/22/2022	MDF Room	Data/Telco Cables	232783			
12/22/2022	MDF Room	Telco Wire Bundle	232799			
12/22/2022	MDF Room	Coax Cable	232758			
12/22/2022	MDF Room	Data Cables	232786			

EL PARAISO AVENUE
716.90'

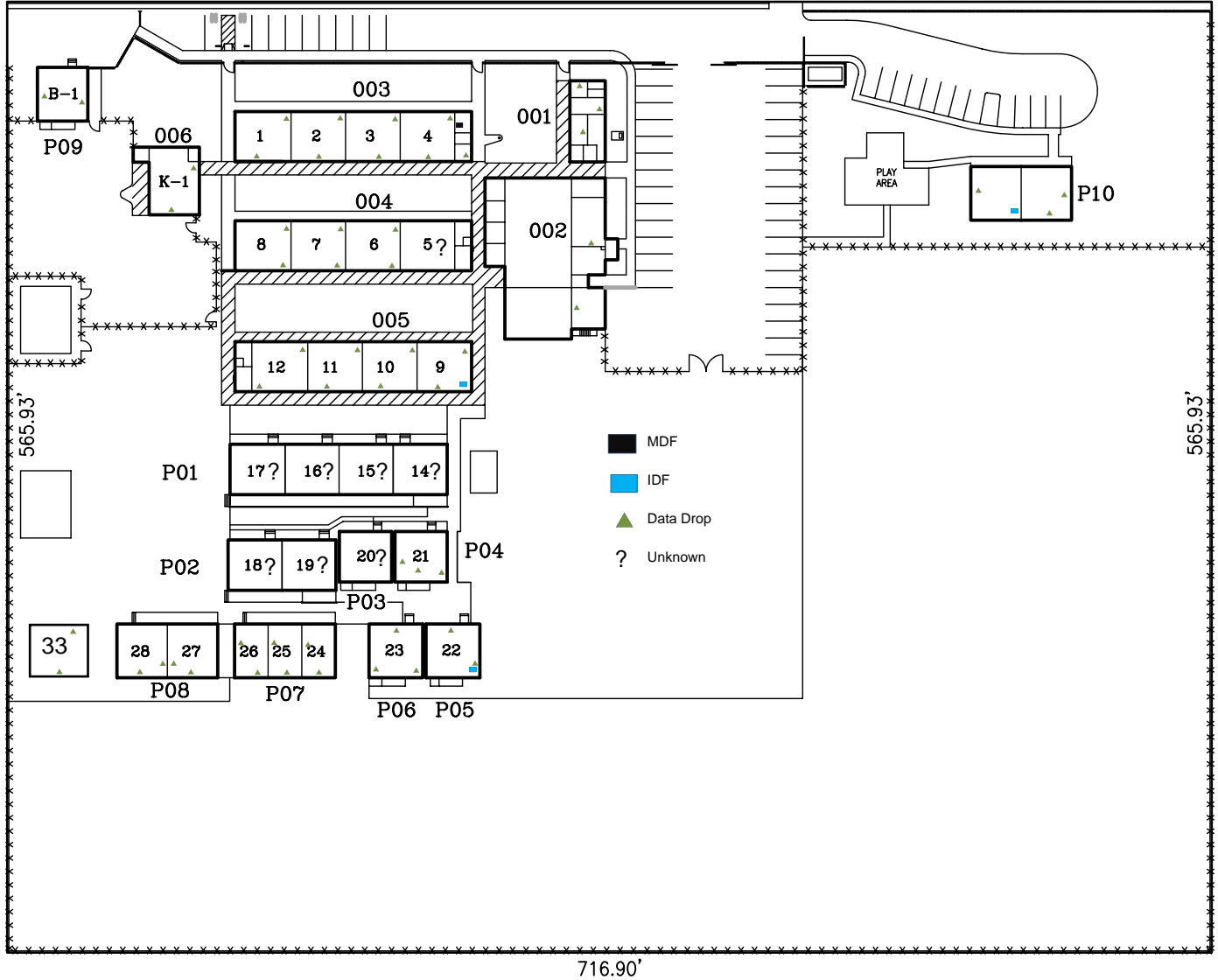

- MDF
- IDF
- Data Drop
- Unknown



NORTH

Scale 1"=100'

SITE AREA: 9.34 ACRES
A.P.N. 037-0231-005

Clayton B. Wire Elementary School (040)
5100 El Paraiso Avenue
SACRAMENTO CITY UNIFIED SCHOOL DISTRICT

EXISTING SITE DIAGRAM

OCTOBER 2001

EXHIBIT "H"

PROJECT LABOR AGREEMENT

for the

SACRAMENTO CITY UNIFIED SCHOOL DISTRICT

PREAMBLE

This Project Labor Agreement ("Agreement") is entered into by and between the Sacramento City Unified School District ("District"), together with contractors and/or subcontractors, who shall become signatory to this Agreement by signing the "Agreement To Be Bound" (Attachment A), and the Sacramento-Sierra Building & Construction Trades Council ("Council") and the local Unions that have executed this Agreement.

RECITALS

WHEREAS, the purpose of this Agreement is to promote efficiency of construction operations during the construction of the District's projects subject to this Agreement, through the use of skilled labor resulting in quality construction outcomes, and to provide for the peaceful settlement of labor disputes and grievances without work disruptions or delays, thereby promoting the District's interest and the public's interest in assuring the timely and cost-effective completion of the District's construction projects; and

WHEREAS, the purpose of this Agreement is to also mutually acknowledge and support the District's Core Value statement and Equity, Access, and Social Justice Guiding Principle; and

WHEREAS, the District's Core Value statement states, *we recognize that our system is inequitable by design and we vigilantly work to confront and interrupt inequities that exist to level the playing field and provide opportunities for everyone to learn, grow, and reach their greatness*; and

WHEREAS, the District's Equity, Access, and Social Justice Guiding Principle ("Guiding Principle") states that *all students are given an equal opportunity to graduate with the greatest number of postsecondary choices from the widest array of options*; and

WHEREAS, the District places high priority upon comprehensive educational programs, training, work-based learning, and workforce development programs for District students and staff in order to best achieve the District's Guiding Principle and to provide meaningful and sustainable careers in the building and construction industry; and

WHEREAS, the successful and efficient completion of the District's construction projects is of the utmost importance to the District and its educational programs and mission; and

WHEREAS, large numbers of workers of various skills will be required in the performance of the construction work, including those to be represented by the Unions affiliated with the Council; and

EXHIBIT "H"

WHEREAS, the use of skilled labor on construction work increases the safety of construction projects as well as the quality of completed work; and

WHEREAS, the Council and Unions commit to use of skilled and trained workforce requirements described in sections 17250.25 and 17407.5 of the Education Code and sections 2600 through 2602 of the Public Contract Code on applicable Projects covered by this Agreement; and

WHEREAS, it is recognized that District construction projects require multiple contractors and bargaining units on the job site at the same time over an extended period of time, and that the potential for work disruption is substantial in the absence of a binding commitment to maintain continuity of work; and

WHEREAS, the Employers and the Unions desire to mutually establish and stabilize wages, hours and working conditions for the workers employed on the construction projects subject to this Agreement in order to promote a satisfactory, continuous and harmonious relationship among the parties to this Agreement; and

WHEREAS, the District desires to provide construction training and employment opportunities for students of and residents within the District through local hire, apprentice and pre-apprentice programs; and

WHEREAS, the parties signatory to this Agreement pledge their full good faith and trust to work towards mutually satisfactory and successful completion of all District construction projects subject to the Agreement; and

WHEREAS, the Sacramento City Unified School District has previously adopted Resolution No. 2774 regarding the use of Project Labor Agreements on District projects.

NOW, THEREFORE, the parties, in consideration of the mutual promises and covenants herein contained, do mutually agree as follows:

ARTICLE 1

DEFINITIONS

- 1.1 "Agreement" means this Project Labor Agreement.
- 1.2 "Agreement to be Bound" means the agreement (attached hereto and incorporated herein as Attachment A) required to be executed by any Employer(s) working on the Project as a precondition to performing Covered Work on the Project.
- 1.3 "Council" means the Sacramento-Sierra Building and Construction Trades Council, which is the local jurisdictional division of the State Building and Construction Trades Council of California, with affiliated trades unions within its geographical jurisdiction of Sacramento, Yolo, Placer, El Dorado, Amador, Nevada, and Sierra Counties.

EXHIBIT "H"

- 1.4 "Completion" means the point at which there is Final Acceptance by the District of a Construction Contract. For purposes of this definition of "Completion," "Final Acceptance" shall mean that point in time at which the District has determined upon final inspection that the work on a Construction Contract has been completed in all respects and all required contract documents, including repairs, warranty work, modifications or punch list work as required under a Construction Contract or when a Contractor performs work under a change order for a Construction Contract, contract drawings, warranties, certificates, manuals and data have been submitted and training completed in accordance with the contract documents and the District has executed a written acceptance of the work.
- 1.5 "Construction Contract" means, except as to section 2.5 (exclusions from Covered Work) public works or improvement contracts approved by the District, including design-bid, design-build, lease-leaseback, or other contracts under which construction work is performed, that are necessary to complete the Project.
- 1.6 "District" means the Sacramento Unified School District and the administrative employees under its Superintendent, including any in house Project Manager designated by the District for the Project.
- 1.7 "Contractor(s)" means any person, firm, corporation, or other entity, or any combination thereof, including joint ventures, and any of its contractors or subcontractors of any tier, or any successor or assigns of such persons or entities, that has entered into a contract with the District, or with any other person or entity contracting for work on the Project on behalf of the District (whether by design-bid, design-build, lease-leaseback or other means), with respect to the construction of any part of the Project under contract terms and conditions approved by the District.
- 1.8 "Local Area" shall be defined as the area within the boundaries of the District, the City of Sacramento, Sacramento County, and the nine counties in section 1.8.4. Residents of the Local Area shall be first referred for the Project, including journey-level workers and apprentices covered by this Agreement, in the following order of priority:
 - 1.8.1 Priority 1: Residents residing within the boundaries of the District.
 - 1.8.2 Priority 2: Residents of the City of Sacramento.
 - 1.8.3 Priority 3: Residents of Sacramento County.
 - 1.8.4 Priority 4: Residents of the Counties of Yolo, Placer, El Dorado, Amador, Sutter, Yuba, Nevada, Sierra, and San Joaquin.
- 1.9 "Master Agreement" means the multi-employer collective bargaining agreement of each of the Unions that covers the geographic area of the Project, copies of which shall be provided to the District upon request.
- 1.10 "Project" means all District construction projects where either the engineer's estimate of the total cost of the project, or the actual cumulative bid amounts submitted by the contractor(s)

EXHIBIT "H"

awarded the Construction Contracts for the Project, exceeds five hundred thousand dollars (\$500,000). All Construction Contracts required to complete an integrated District construction project shall be considered in determining the threshold value. The District and the Council may mutually agree in writing to add additional projects to the scope of Projects to be covered by this Agreement. The term "Project" applies to each and all projects as defined in this section, whether used in the singular or plural herein. Routine maintenance of District properties is not covered by the scope of this Agreement.

- 1.11 "Project Manager" means a person, including a District employee, firm or other entity designated by the District to manage, coordinate or administer the construction work on a Project subject to this Agreement.
- 1.12 "Union" or "Unions" means the Sacramento-Sierra Building and Construction Trades Council and the local Unions that are signatory to this Agreement, acting on their own behalf and on behalf of their respective affiliates and member organizations whose names are subscribed hereto and who have through their officers executed this Agreement. The Council and the local Unions are collectively referred to herein as the "Unions."

ARTICLE 2

SCOPE OF AGREEMENT

- 2.1 Parties. This Agreement shall apply and is limited to all Contractor(s), the District and the Unions that are signatory to this Agreement.
- 2.2. Applicability. For purposes of this Agreement, Construction Contracts shall be considered completed as set forth in Section 1.4, including when the District directs a Contractor to engage in repairs, warranty work, modifications or punch list work as required under a Construction Contract or when a Contractor performs work under a change order for a Construction Contract. This Agreement shall govern all Construction Contracts awarded on the District Projects that are subject to this Agreement. Except for exclusions from the Covered Work described in section 2.5, for purposes of this Agreement, a Construction Contract shall be considered completed as described in Section 1.4, except when the District's authorized representative directs a Contractor to engage in repairs, warranty work, modifications, or punch list work as required under a Construction Contract or when a Contractor performs work under a change order for a Construction Contract.
- 2.3 Covered Work. This Agreement covers, without limitation all on-site preparation, surveying, construction, alteration, demolition, installation, improvement, remediation, retrofit, painting, or repair of buildings, structures and other works and related activities for the Project that is within the craft jurisdiction of one of the Unions and which is directly or indirectly part of the Project, including, without limitation to the following examples, geotechnical and exploratory drilling, temporary HVAC, landscaping and temporary fencing, pipelines (including those in linear corridors built to serve the Project), pumps, pump stations, start-up, and modular furniture installation, On-site work includes work done for the

EXHIBIT "H"

Project in temporary yards, dedicated sites, or areas adjacent to the Project, and at any on-site or off-site batch plant constructed solely to supply materials to the Project. This scope of work includes all soils and materials testing and inspection where such testing and inspection is a classification covered by an applicable Master Agreement or in which a prevailing wage determination has been published.

- 2.3.1 This Agreement applies to any start-up, calibration, commissioning, performance testing, repair, maintenance, and operational revisions to systems and/or subsystems for the Project performed after Completion, unless performed by District employees.
- 2.3.2 This Agreement covers all on-site fabrication work over which the District, Contractor(s)/Employer(s) or subcontractor(s) possess the right of control (including work done for the Project in any temporary yard or area established for the Project). Additionally, this Agreement covers any off-site work, including fabrication necessary for the Project defined herein, that is covered by a current Schedule A Agreement or local addenda to a National Agreement of the applicable Union(s) that is in effect as of the execution date of this Agreement.
- 2.3.3 It is expressly agreed and understood by the Parties that the District shall have the right to purchase material and equipment from any source and the craftsperson covered under this Agreement will handle and install such material and equipment. There shall be no limitation or restriction upon the choice of material or upon the full use and installation of equipment, machinery, materials, tools or other labor-saving devices other than as set forth herein. The lawful fabrication provisions of the appropriate national or local agreements shall be applicable.
- 2.3.4 The furnishing of supplies, equipment or materials which are stockpiled for later use shall not be covered by this Agreement. However, construction trucking work, such as the hauling and delivery of ready-mix, asphalt, aggregate, sand, or other fill or similar material which is incorporated into the construction process as well as the off-hauling of debris and excess fill, material and/or mud, shall be covered by the terms and conditions of this Agreement to the fullest extent allowed by prevailing wage law and determinations of the California Department of Industrial Relations. Contractor(s)/Employer(s), including brokers, of persons providing construction trucking work shall provide certified payroll records to the District within ten (10) days of written request or as required by bid specifications.
- 2.3.5 The on-site installation or application of all items shall be performed by the craft having jurisdiction over such work; provided, however, it is recognized that installation of specialty items which may be furnished by the District or a Contractor shall be performed by construction persons employed under this Agreement who may be directed by other personnel in a supervisory role; provided, however, in limited circumstances requiring special knowledge of the particular item(s), may be performed by construction persons of the manufacturer where necessary to protect a manufacturer's warranty, provided the Contractor/Employer using the manufacturer can demonstrate by an enumeration of specific tasks that the work cannot be performed by craft workers under this Agreement. All work of a specialty nature to

EXHIBIT "H"

be performed by the employees of an equipment manufacturer necessary to protect the warranty on such equipment shall be identified and discussed at the Preconstruction Conference provided in Article V of this Agreement.

- 2.3.6 Work covered by this Agreement within the following craft jurisdictions shall be performed under the terms of their National Agreements as follows: the National Agreement of Elevator Constructors, the National Transient Lodge (NTL) Articles of Agreement, the National Stack/Chimney Agreement, the National Cooling Tower Agreement, and any instrument calibration work and loop checking shall be performed under the terms of the UA/IBEW Joint National Agreement for Instrument and Control Systems Technicians, with the exception that Articles IV, XV and XVI of this Agreement shall apply to such work.
- 2.4 The following shall be excluded from Covered Work:
 - 2.4.1 Work of non-manual employees, including, but not limited to, superintendents, supervisors above the level of general foreman (except those covered by any applicable Master Agreement), staff engineers, building inspectors, timekeepers, clerks, office workers, including messengers, guards, safety personnel, emergency medical and first aid technicians, and other professional, engineering, administrative, executive and management employees;
 - 2.4.2 Equipment and machinery owned or controlled and operated by the District;
 - 2.4.3 Any work performed on or near or leading to or on to the site of work covered by this Agreement and undertaken by state, county, city or other governmental bodies, or their contractor, or by public utilities or their contractors;
 - 2.4.4 Off-site maintenance of leased equipment and on-site supervision of such work;
 - 2.4.5 Work performed by employees of a manufacturer or vendor on the manufacturer's or vendor's equipment if necessary to satisfy the guarantee or warranty on such equipment and where performance of the work is expressly stated in the manufacturer's or vendor's written warranty or guarantee to be a condition for the warranty or guarantee for such products. For any work performed pursuant to this provision, the Contractor shall provide copies of the written warranty requirement to the District, Project Manager, the Council and the affected local Union prior to the commencement of work by the manufacturer or vendor. This exclusion does not apply to any on site construction work subcontracted by such manufacturer or vendor.
 - 2.4.6 District procurement or use of modular buildings;
 - 2.4.7 Off-site maintenance of leased equipment and on-site supervision of such work;
 - 2.4.8 Laboratory or specialty testing or inspection not covered by an applicable Master Agreement;

EXHIBIT "H"

- 2.4.9 Non-construction support services contracted by the District or any Contractor in connection with this Project;
- 2.4.10 All Maintenance work contracted by the District;
- 2.4.11 All work by employees of the District.

ARTICLE 3

SUBCONTRACTING

- 3.1 Each Contractor agrees that it will contract for the assignment, awarding or subcontracting of Covered Work, or authorize another party to assign, award or subcontract Covered Work, only to a person, firm, corporation, or other entity that, at the time the contract is executed, has become a party to this Agreement by executing Attachment A, the Agreement to be Bound.
- 3.2 Each Contractor agrees that it will contract or subcontract the performance of Covered Work only to a person, firm, corporation, or other entity that is or becomes a party to this Agreement. Any Contractor performing Covered Work on the Project shall, as a condition to working on the Project, perform all work under the terms of this Agreement and the applicable Master Agreement. Before being authorized to perform any Covered Work, Contractors shall become a party to this Agreement by signing Attachment A, the Agreement to be Bound. Every Contractor shall notify the Council in writing within five (5) business days after it has contracted to assign, award, or subcontract Covered Work, or to authorize another party to assign, award or subcontract Covered Work in accordance with Section 3.1 or this Section 3.2 and shall at the same time provide to the Council a copy of the executed Agreement to be Bound. The District shall also provide copies to the Council of all executed Agreements to be Bound that it receives within fifteen (15) days of receipt.
- 3.3 Contractors and all subcontractors of whatever tier who have been awarded contracts for work covered by this Agreement commit to comply with the skilled and trained workforce requirements provided in California Education Code sections 17250.25 and 17407.5 and California Public Contract Code sections 2600 et seq. on applicable Projects.
- 3.4 Nothing in this Agreement shall in any manner whatsoever limit the rights of the District or any Contractor to subcontract Covered Work or to select its contractors or subcontractors; provided, however, that all Contractors, at all tiers, assigning, awarding, contracting, or performing Covered Work, or authorizing another to assign, award, contract or perform Covered Work, shall be required to comply with the provisions of this Agreement. Each Contractor shall notify each of its contractors and subcontractors of the provisions of this Agreement and require as a condition precedent to the assigning, awarding, or subcontracting of any Covered Work, or allowing any subcontracted Covered Work to be performed, that all such contractors and subcontractors at all tiers become signatory to this Agreement. Any Contractor that fails to provide the Council with the Agreement to be

EXHIBIT "H"

Bound executed by its contractor or subcontractor shall be liable for any failure of that contractor or subcontractor, or any contractor or subcontractor at a lower tier, to comply with the provisions of this Agreement, including any contributions to any trust funds that the contractor or subcontractor, or any subcontractor to that subcontractor, fails to make. Nothing in this Agreement shall be construed to interfere with or supersede the usual and customary legal remedies available to the Unions and/or employee benefit Trust Funds to collect delinquent Trust Fund contributions from Contractors on the Project.

- 3.5 Nothing in this Agreement shall limit the District's right to combine, consolidate, or cancel contracts for Project construction, or to comply with public agency contracting laws.

ARTICLE 4

WAGES AND BENEFITS

- 4.1 All employees covered by this Agreement (including foremen and general foremen if they are covered by the Master Agreement) shall be classified and paid wages and other compensation, including but not limited to travel, subsistence, and shift premium pay, and contributions made on their behalf to multi-employer trust funds, all in accordance with the then current multi-employer Master Agreement of the applicable Union and in compliance with the applicable prevailing wage rate determination established pursuant to the California Labor Code by the Department of Industrial Relations.
- 4.2 During the period of construction on this Project, the Contractors agree to recognize and put into effect such increases in wages and recognized fringe benefits as shall be negotiated between the various Unions and the historically recognized local bargaining parties on the effective date as set forth in the applicable Master Agreement. The Unions shall notify the Contractors in writing of the specific increases in wages and recognized fringe benefits and the date on which they become effective.

ARTICLE 5

NO STRIKES - NO LOCKOUTS

- 5.1 During the term of this Agreement, there shall be no strikes, sympathy strikes, picketing, work stoppages, picket-related hand billing, slowdowns, interference with the work or other disruptive activity for any reason by the Union or by any employee, and there shall be no lockout by any Contractor. Failure of any Union or employee to cross any picket line established at the Contractor's Project site is a violation of this Article.
- 5.2 The Union shall not sanction, aid or abet, encourage, or continue any work stoppage, strike, picketing or other disruptive activity at the Project site and shall undertake all reasonable means to prevent or to terminate any such activity. No employee shall engage in activities which violate this Article. Any employee who participates in or encourages any activities which interfere with the normal operation of the Project shall be subject to

EXHIBIT "H"

disciplinary action, including discharge, and, if justifiably discharged for the above reasons, shall not be eligible for rehire on the same project for a period of not less than ninety (90) days.

- 5.3 The Union(s) agrees that if any union or any other persons, whether parties to this Agreement or otherwise, engage in any picketing or work stoppages, the signatory Unions shall consider such work stoppage or picketing to be illegal and refuse to honor such picket line or work stoppage.
- 5.4 In the event of any work stoppage, strike, sympathy strike, picketing interference with the work or other disruptive activity in violation of this Article, the Contractor may suspend all or any portion of the Project work affected by such activity at the Contractor's discretion and without penalty, and the District may replace any Contractor whose employees have not reported to work with any other contractor or subcontractor.
- 5.5 In addition to any other action at law or equity, any party may elect to have the matter decided by a neutral arbitrator in accordance with the following procedure when a breach of this Article is alleged, after the Union(s) or Contractor(s) has been notified of the fact.
- 5.5.1 A party invoking this procedure shall notify Robert Hirsch, as the permanent arbitrator, or Barry Winograd, as the alternate arbitrator under this procedure. In the event that the permanent arbitrator is unavailable at any time, the alternate will be contacted. If neither is available, then the American Arbitration Association shall select an alternative arbitrator within 24 hours of notice. Notice to the Arbitrator shall be by the most expeditious means available, with notice by fax or electronic means or any other effective written means to the party alleged to be in violation and the involved International Union President and/or local Union.
- 5.5.2 Upon receipt of said notice, the District Superintendent, or their designee, shall contact the designated Arbitrator identified above who will attempt to convene a hearing within twenty-four (24) hours if it is contended that the violation still exists.
- 5.5.3 The Arbitrator shall notify the parties by fax or electronic means or any other effective written means of the place and time he has chosen for this hearing. Said hearing shall be completed in one session. A failure of any party or parties to attend said hearing shall not delay the hearing of evidence or issuance of an Award by the Arbitrator.
- 5.5.4 The sole issue at the hearing shall be whether or not a violation of this Article has in fact occurred. The Award which shall be final, and binding shall be issued in writing within three (3) hours after the close of the hearing and may be issued without an opinion. If any party desires an opinion, one shall be issued within fifteen (15) days, but its issuance shall not delay compliance with, or enforcement of, the Award. The Arbitrator may order cessation of the violation of this Article by the Union or Contractor, and such Award shall be served on all parties by hand or registered mail upon issuance. Should a party found in violation of this Article

EXHIBIT "H"

fail to comply with an Arbitrator's award to cease the violation, the party in violation shall pay to the affected party as liquidated damages the sum of ten thousand dollars (\$10,000) for the first shift for which it failed to comply, or portion thereof, and ten thousand dollars (\$10,000) for each subsequent shift for which it failed to comply, until such violation is ceased. The Arbitrator shall retain jurisdiction to resolve any disputes regarding the liquidated damages claimed under this Section.

- 5.5.5 Such Award may be enforced by any court of competent jurisdiction upon the filing of this Agreement and all other relevant documents referred to hereinabove in the following manner. The fax or electronic notice of the filing of such enforcement proceedings shall be given to the other party. In the proceeding to obtain a temporary order enforcing the Arbitrator's Award as issued under Section 5.5.4 of this Article, all parties waive the right to a hearing and agree that such proceedings may be ex parte. Such agreement does not waive any party's right to participate in a hearing for a final order of enforcement. The Court's order or orders enforcing the Arbitrator's Award shall be served on all parties by hand or by delivery to their last known address or by certified mail.
- 5.5.6 Any rights created by statute or law governing arbitration proceedings inconsistent with the above procedure or which interfere with compliance therewith are hereby waived by the parties to whom they accrue.
- 5.5.7 The fees and expenses of the Arbitrator shall be borne by the party or parties found in violation, or in the event no violation is found, such fees and expenses shall be borne by the moving party.
- 5.6 The procedures contained in Section 5.5 shall be applicable to alleged violations of this Article. Disputes alleging violation of any other provision of this Agreement, including any underlying disputes alleged to be in justification, explanation, or mitigation of any violation of this Article, shall be resolved under the grievance procedures of Article 9.
- 5.7 In the case of nonpayment of wages or trust fund contributions on the Project, the Union shall give the District and the Contractor(s) three (3) business days' notice when nonpayment of trust fund contributions has occurred and one (1) business days' notice when nonpayment of wages has occurred or when paychecks being tendered to a financial institution normally recognized to honor such paychecks will not honor such paycheck as a result of insufficient funds, of the intent to withhold labor from the Contractor(s)' or their subcontractor's workforce, during which time the Contractor shall have the opportunity to correct the default. In this instance, a Union's withholding of labor (but not picketing) from a Contractor who has failed to pay its fringe benefit contributions or failed to meet its weekly payroll shall not be considered a violation of this Article. In the event the Union or any of its members withhold their services from such contractor or subcontractor, District shall have the right to replace such contractor or subcontractor with any other contractor or subcontractor who executes the Agreement to be Bound.

EXHIBIT "H"

- 5.8 It will not be a violation of this Agreement when the Contractor considers it necessary to shut down to avoid the possible loss of human life because of an emergency situation that could endanger the life and safety of an employee. In such cases, employees will be compensated only for the actual time worked. In the case of a situation described above whereby the Contractor requests employees to wait in a designated area available for work, the employees will be compensated for the waiting time.
- 5.9 If a Master Agreement expires before the Contractor completes the performance of work under the Construction Contract and the Union or Contractor gives notice of demands for a new or modified Master Agreement, the Union agrees that it will not strike on work covered under this Agreement and the Union and the Contractor agree that the expired Master Agreement shall continue in full force and effect for work covered under this Agreement until a new or modified Master Agreement is reached. If the new or modified Master Agreement provides that any terms of the Master Agreement shall be retroactive, the Contractor agrees to comply with any retroactive terms of the new or modified Master Agreement which are applicable to employees who were employed on the projects during the interim, with retroactive payment due within seven (7) days of the effective date of the modified Master Agreement subject to section 4.3.

ARTICLE 6

WORK ASSIGNMENTS AND JURISDICTIONAL DISPUTES

- 6.1 The assignment of Covered Work will be solely the responsibility of the Contractor performing the work involved; and such work assignments will be in accordance with the Plan for the Settlement of the Jurisdictional Disputes in the Construction Industry (the "Plan") or any successor Plan.
- 6.2 All jurisdictional disputes on this Project between or among the building and construction trades Unions and the Contractors parties to this Agreement, shall be settled and adjusted according to the present Plan established by the Building and Construction Trades Department or any other plan or method of procedure that may be adopted in the future by the Building and Construction Trades Department. Decisions rendered shall be final, binding, and conclusive on the Contractors and Unions parties to this Agreement.
- 6.3 If a dispute arising under this Article involves the Northern California Carpenters Regional Council or any of its subordinate bodies, an Arbitrator shall be chosen by the procedures specified in Article V, Section 5, of the Plan from a list composed of John Kagel, Thomas Angelo, Robert Hirsch, and Thomas Pagan, and the Arbitrator's hearing on the dispute shall be held at the offices of the California State Building and Construction Trades Council in Sacramento, California within fourteen (14) days of the selection of the Arbitrator. All other procedures shall be as specified in the Plan.
- 6.4 All jurisdictional disputes shall be resolved without the occurrence of any strike, work stoppage, or slow-down of any nature and the Contractor's assignment shall be adhered to until the dispute is resolved. Individual employees violating this section shall be subject to immediate discharge.

EXHIBIT "H"

ARTICLE 7

JOINT LABOR/MANAGEMENT MEETINGS

- 7.1 Joint Labor/Management Meetings. During the period of any work performed under this Agreement, the Project Manager, or District designee, may schedule monthly Joint Labor/Management Meetings that include the Project Manager, or the District's designee, the Contractors and the Unions. The purpose of these meetings is to promote harmonious labor/management relations, ensure adequate communications and advance the proficiency and efficiency of the employees and the Contractors on the Project. These meetings may include a discussion of safety, craft resource requirements, scheduling and productivity of work performed at the Project. The Union representative shall keep minutes of any such meetings and the minutes shall be subject to approval at any subsequent meeting. Any such meetings may be in person, virtually or by conference call. It shall be mandatory for a representative of the Unions to participate in such meetings.
- 7.2 A Pre-Job Conference shall be scheduled by the District prior to the commencement of work to establish the scope of work in each Contractor's contract. When a contract has been let to a Contractor covered by this Agreement, a job conference and/or markup meeting shall be scheduled by the District upon request of any Union, Contractor or the District.

ARTICLE 8

MANAGEMENT RIGHTS

- 8.1 The Contractor(s) retains full and exclusive authority for the management of their work forces for all work performed under this Agreement. This authority includes, but is not limited to the right to:
- A. Plan, direct and control the operation of all the work.
 - B. Decide the number and types of employees required to perform the work safely and efficiently. The lawful staffing provisions of the applicable Master Agreement shall be recognized.
 - C. Hire, promote and layoff employees as deemed appropriate to meet work requirements and/or skills required.
 - D. Require all employees to observe the District and Contractor Project Rules, Security and Safety Regulations, consistent with the provisions of this Agreement. These Project Rules and Regulations shall be reviewed and mutually agreed upon at the Pre-Job meeting and supplied to all employees and/or posted on the jobsite.
 - E. Discharge, suspension or discipline will be handled under the applicable craft agreement.

EXHIBIT "H"

- F. Assign and schedule work at its sole discretion and determine when overtime will be worked. There shall be no refusal by a craft to perform work assigned, including overtime work. However, individual craftspeople shall not be required to work overtime unless specifically dispatched for overtime work. Any cases of a craft's refusal to work overtime shall be subject to the grievance procedure.
 - G. Utilize any work methods, procedures or techniques and select and use any type or kind of materials, apparatus or equipment regardless of source, manufacturer or designator (in accordance with Article 2).
 - H. The foregoing listing of management rights shall not be deemed to exclude other functions not specifically set forth herein. The Contractors, therefore, retain all legal rights not specifically enumerated in this Agreement.
- 8.2 All workers employed or otherwise used on a Project shall comply with the District's Drug and Alcohol-Free Workplace Policy (BP 4020) and Employee Drug Testing Policy (BP 41 12.41, 4212.41, 4312.41) and applicable regulations as amended from time to time. If not otherwise specified, the drug testing protocol shall be in compliance with 49 Code of Federal Regulations (CFR) section 382.105 (Testing procedures) which incorporates 49 CFR Part 40.

ARTICLE 9

GRIEVANCE PROCEDURE

- 9.1 It is mutually agreed that any question arising out of and during the term of this Agreement involving its interpretation and application (other than matters subject to Section 5.5 and Union jurisdictional disputes subject to Article 6) shall be considered a grievance. Questions between or among parties signatory to a Master Agreement arising out of or involving the interpretation of a Master Agreement shall be resolved under the grievance procedure provided in that Master Agreement.
- 9.2 The District and other Contractors, as well as the Unions, may bring forth grievances under this Article.
- 9.3 A grievance shall be considered null and void if not brought to the attention of the effect party by the grievant within five (5) working days after the incident that initiated the alleged grievance occurred or was discovered, whichever is later. The term "working days" as used in this Article shall exclude Saturdays, Sundays, or holidays regardless of whether any work is actually performed on such days.
- 9.4 Grievances shall be settled according to the following procedure, except those grievances that do not involve an individual grievant, which shall be discussed by the District, and the Council and then, if not resolved within five (5) working days of written notice unless extended by mutual consent, commence at Step 4:

Step 1

EXHIBIT "H"

The Steward and the grievant shall attempt to resolve the grievance with the craft supervisor within five (5) working days after the Grievance has been brought to the attention of the Contractor.

Step 2

In the event the matter remains unresolved in Step 1 above after five (5) working days, within five (5) working days thereafter, the alleged grievance may be referred in writing to the Business Manager(s) of the Union(s) affected and the site construction manager or Labor Relations representative of the Contractor(s) for discussion and resolution. A copy of the written grievance shall also be mailed, faxed or emailed to the District.

Step 3

In the event the matter remains unresolved in Step 2 above within five (5) working days, within five (5) working days thereafter, the grievance may be referred in writing to the Business Manager(s) of the affected Union(s) involved and the Manager of Labor Relations of the Contractor(s) or the Manager's designated representative and the District for discussion and resolution.

Step 4

If the grievance is not settled in Step 3 within five (5) working days, within five (5) days thereafter, either party may request the dispute be submitted to neutral arbitration or the time may be extended by mutual consent of both parties. The request for arbitration and/or the request for an extension of time must be in writing with a copy to the District. Should the parties be unable to mutually agree on the selection of a neutral Arbitrator, selection for that given arbitration shall be made by seeking a list of seven (7) labor arbitrators with construction experience from the Federal Mediation and Conciliation Service and alternately striking names from the list of names on the list until the parties agree on an Arbitrator or until one name remains. The first party to strike a name from the list shall alternate between the party bringing forth the grievance and the party defending the grievance. District shall keep a record of the sequence and shall notify the parties to the grievance as to which party has the right to strike a name first.

- 9.5 The Arbitrator shall conduct a hearing at which the parties to the grievance shall be entitled to present testimonial and documentary evidence. Hearings will be transcribed by a certified court reporter. The parties shall be entitled to file written briefs after the close of the hearing and receipt of the transcript.
- 9.6 Upon expiration of the time for the parties to file briefs, the Arbitrator shall issue a written decision that will be served on all parties and on the District. The Arbitrator shall have the authority to utilize any equitable or legal remedy to prevent and/or cure any breach or threatened breach of this Agreement. The Arbitrator's decision shall be final and binding as to all parties signatory to this Agreement.
- 9.7 The cost of the Arbitrator and the court reporter, and any cost to pay for facilities for the hearing, shall be borne equally by the parties to the grievance. All other costs and expenses in connection with the grievance hearing shall be borne by the party who incurs them.

EXHIBIT "H"

- 9.8 The Arbitrator's decision shall be confined to the issue(s) posed by the grievance, and the Arbitrator shall not have the authority to modify, amend, alter, add to or subtract from any provision of this Agreement.
- 9.9 Any party to a grievance may invite the District to participate in resolution of a grievance. The District may, at its own initiative, participate in Steps 1 through 3 of the grievance procedure.
- 9.10 In determining whether the time limits of Steps 2 through 4 of the grievance procedure have been met, a written referral or request shall be considered timely if it is personally delivered, sent by overnight mail or faxed within the five (5) working day period. Any of the time periods set forth in this Article may be extended in writing by mutual consent of the parties to the grievance, and any written referral or request shall be considered timely if it is personally delivered, sent by overnight mail or faxed during the extended time period.

ARTICLE 10

EMPLOYEE REPRESENTATION AND REFERRAL

- 10.1 The Employers recognize the Unions as the sole bargaining representatives of all craft employees performing Covered Work under this Agreement. Authorized representatives of the Unions shall have reasonable access to the Project whenever work covered by this Agreement is being, has been, or will be performed on the Project. All authorized representatives of the Unions must comply with the required check-in procedure prior to visiting the work area.
- 10.2 Employees are not required to become or remain union members as a condition of performing Covered Work under this Agreement. Employers shall make and transmit all deductions for union dues, fees, and assessments that have been authorized by employees in writing in accordance with the applicable Master Agreement. Nothing in this Section 10.2 is intended to supersede the requirements of applicable Master Agreements as to those Employers otherwise signatory to such Master Agreements and as to the employees of those Employers who are performing Covered Work.
- 10.3 In filling craft job requirements, Employers performing Covered Work shall utilize and be bound by the registration facilities and referral systems established or authorized by the Unions ("Job Referral System"). Such Job Referral System shall be operated in a non-discriminatory manner and in full compliance with all federal, state, and local laws and regulations, including those which require equal employment opportunities and non-discrimination. The Employers shall have the right to reject any applicant referred by the Unions in accordance with this Article 10.
- 10.4 The Employers shall have the unqualified right to select and hire directly all supervisors above general foreman it considers necessary and desirable, without such persons being referred by the Unions.
- 10.5 In the event that referral facilities maintained by the Union are unable to fill the requisition of an Employer for employees within a forty-eight (48) hour period (Saturdays, Sundays and Holidays excluded) after such requisition is made by the Employer, the Employer shall

EXHIBIT "H"

be free to obtain such workers from any source. An Employer who hires any personnel to perform Covered Work on the Project pursuant to this Section shall immediately provide the appropriate Union with the name and address of such employee(s) and shall immediately refer such employee(s) to the appropriate Union to satisfy the requirements of this Article 10.10.6. Unions will exert their utmost efforts to recruit sufficient numbers of skilled and trained craft persons to fulfill the requirements of the Contractor/Employer(s). On Projects governed by Education Code sections 17250.25 and 17407.5, the Unions shall consider a Contractor's request to transfer skilled and trained employees to work on Projects in a manner consistent with the Union's referral procedures.

- 10.7 Subject to the limitation of applicable law and the hiring hall procedures of the Unions, the Parties to this Agreement mutually support the development of increased numbers of skilled construction workers from District graduates and the residents of the City of Sacramento specifically and from the residents of Sacramento County generally, to meet the needs of the Projects and the requirements of the industry generally. To facilitate this goal, the Unions agree to encourage the referral and utilization of qualified District graduates and the City of Sacramento and Sacramento County residents as journeypersons and apprentices on the Projects.

ARTICLE 11

REFERRAL-LOCAL COMMUNITY WORKFORCE PROVISIONS

- 11.1 Contractors performing Covered Work on the Project shall, in filling craft job vacancies, utilize and be bound by the registration facilities and referral systems established or authorized by the Unions signatory to this Agreement. The Union will exert and document their best efforts to recruit and identify residents of the Local Area, in a manner that is consistent with the District's Core Value and Guiding Principle, and those individuals shall be referred for Project work first, to the extent allowed by law, and consistent with the Union's hiring hall provisions, and as long as they possess the requisite skills and qualifications, including journeymen and apprentices covered by this Agreement.
- 11.2 The Job Referral System shall be operated in a non-discriminatory manner and in full compliance with all federal, state, and local laws and regulations, including those which require equal employment opportunities and non-discrimination. The Contractor(s) shall have the right to reject any applicant referred by the Union(s), in accordance with the applicable Master Agreement. The Unions shall be the primary source of all craft labor employed on the Project, however, a Contractor with a core workforce may request by name, and the local Union shall honor, referral of such Contractor's regular and experienced personnel ("Core Employees") who have applied to the applicable Union to perform Covered Work on the Project. For purposes of this Agreement, a Core Employee is a person who meets all the following:

- (1) Possesses any license required by state or federal law for the Project work to be performed;

EXHIBIT "H"

- (2) Worked a total of at least one thousand (1,000) hours in the construction craft during the prior two (2) years;
 - (3) Has been on the Contractor's active payroll for at least ninety (90) out of the one hundred and twenty (120) calendar days prior to the contract award; and
 - (4) Has the ability to perform safely the basic functions of the applicable trade.
- 11.3 The Union will refer to such Contractor one journeyman employee from the hiring hall out-of-work list for the affected trade or craft and will then refer one of the Contractor's Core Employees as a journeyman, until such Contractor has hired six (6) Core Employees, whichever occurs first. Thereafter, all additional employees in the affected trade or craft shall be hired exclusively from the hiring hall out-of-work list(s). For the duration of the Contractor's work on the Project, the ratio shall be maintained. When such Contractor's workforce is reduced, employees shall be reduced in the same one for one ratio of Core Employees to hiring hall referrals as was applied in the initial hiring. Contractors that are signatory to a Master Agreement with Union(s) signatory hereto must comply with the hiring hall provisions contained in the applicable Master Agreement, and nothing in the referral provisions of this Agreement shall be construed to supersede the local hiring hall provisions of the Master Agreement(s) as they apply to such Contractors.
- 11.4 In the event the referral facilities maintained by the Unions do not refer the employees as requested by the Contractor within a forty-eight (48) hour period after such requisition is made by the Contractor (Saturdays, Sundays and holidays excepted), the Contractor may employ applicants from any source. Contractors shall immediately notify and provide the appropriate Union(s) with the name and address of such gate-hires, who shall be bound by the provisions of this Article.

It is in the interest of the parties to this Agreement to facilitate employment of District and Local Area residents, including parents, guardians or other care givers of students attending the District's schools, and to use resources in the Local Area in construction of a Project. The "Local Area" shall be defined as the area within the boundaries of the District, the City of Sacramento, Sacramento County, and the nine counties outlined in section 1.8.4, in priority order outlined in section 1.8. To the extent allowed by law, and consistent with the Union's hiring hall provisions, and as long as they possess the requisite skills and qualifications, residents of the Local Area shall be first referred for Project work, including journeymen and apprentices covered by this Agreement. It is the goal of the parties that not less than fifty (50) percent of all hours worked on the Project, on a craft-by-craft basis, be worked by residents of the Local Area (including fifty (50) percent of the total hours worked by any Core Employees). The Union shall provide a list of individuals referred for Project work and their applicable zip code of residence to the District, upon request. Contractors will be required to submit certified weekly payroll records to the District along with monthly workforce utilization reports documenting the Contractor's compliance with the requirements described in this Article. At a minimum, the monthly reports must include data on Local Area resident work hour utilization on the Project. An annual report shall be submitted to the Board on the number of workers employed, or contracted for,

EXHIBIT "H"

within the Local Area. Provisions of this article shall be an item for discussion at each Pre-Job Conference outlined in Article.

ARTICLE 12

MUTUAL COMMITMENT TO SUPPORTING EDUCATIONAL AND CAREER DEVELOPMENT OPPORTUNITIES FOR DISTRICT STUDENTS

- 12.1 The Parties agree that this Agreement is also intended to formalize partnerships between the Unions and the District to support the educational and career development of the District's students, and to help develop the next generation of skilled construction workers. The Parties agree to support District Construction and Design Academies or Pathways within the District ("Academy" or "Pathway") in order to carry out the training and employment objectives of this Agreement, including providing District students with the opportunities and skills necessary to enter post-secondary study and to pursue lifelong training within the broader context of the building trades industry, and to develop and reinforce academic course standards in order to maximize career opportunities and technical competency. The Parties agree to the following actions in order to implement this mutual commitment.
- 12.2 Contractors shall employ apprentices in the respective drafts to perform such work as is within their capabilities and which is customarily performed by the craft in which they are indentured. The Parties agree that apprentices may comprise up to twenty (20) percent of each craft's workforce at any time, unless the state approved apprenticeship standards or regulations or the applicable Master Agreement establish a lower maximum percentage.
- 12.3 The Union shall provide speakers at District Academies, at no cost to the District, through the Multi-Craft Core Curriculum (MC3) program and at other mutually agreed upon school functions and events.
- 12.4 In order to facilitate the goals of the Academy, the District and Council agree to create an Advisory Board for the Luther Burbank High School Construction and Design Academy, American Legion High School's Residential and Commercial Construction Academy (collectively "High Schools"), Rosemont High School Engineering , Construction and Design, and participate in the District-level Pathway Advisory Board, which will conduct meetings as determined by the District during the school year to develop the goals of the Academy; plan for the presentation and content of training lectures to facilitate employable skills in the construction trades; develop a summer schedule for training; organize and develop summer internship positions; assist in planning curriculum scope and sequencing; design cocurricular activities; identify sources for educational and financial support; and otherwise initiate steps to carry out the goals of the Academy.
- 12.4.1 The High School Advisory Boards shall consist of the appropriate membership as outlined by current regulations and requirements placed upon the District. The Advisory Board, in coordination with the District's Career Services representative, shall develop and implement a plan for annual assessment of the goals and

EXHIBIT "H"

objectives to maximize the employability of students and District graduates, including summer internship opportunities. A quorum for the Advisory Board meeting shall be at least one member representing the building trades JATCs; one member representing the Council; and one member representing the District.

- 12.4.2 The Academy Advisory Board will collaborate with post-graduate training programs, such as the Northern California Construction Training and American River College's Stripe Program, in order to assist graduates in obtaining an internship into a JATC.
- 12.4.3 The training and employment program of the interns shall be developed by the Academy Advisory Board such that graduating interns shall possess the skills, training, and educational background to help the graduate achieve priority on the lists of the building trades to the degree allowed under each JATC's application process including those programs that allow direct entry. It is recognized that the Apprenticeship Programs operate according to existing Standards approved by the California Department of Industrial Relations, Division of Apprenticeship Standards, and the standards set forth in the collective bargaining agreements for each building trades union and that any such priority shall be in accordance with such Standards and agreements.
- 12.5 The Parties agree to meet and identify additional mutually agreed upon specific actions to meet these goals, including, but not limited to, consideration of: (1) measures to facilitate teacher training in Multi-Craft Core Curriculum (MC3); (2) measures to provide student employment opportunities through externships, internships and/or post-graduation apprenticeship placement; (3) measures to provide hands-on training opportunities for students; (4) measures to facilitate identification of funding sources to provide recent women, minoritized and low-income District graduates scholarships or assistance in the purchase of tools and other equipment needed for apprenticeship programs; (5) support to identify and find funding for a Pre-Apprentice / Internship / Apprenticeship Coordinator to assist District Academies. These additional commitments shall be set forth in a Memorandum of Understanding (MOU) to this Agreement ("Union Educational and Career Development Support MOU"). Parties agree to meeting twice before August 1, 2022, and throughout the month of August to identify the mutually agreeable terms of the MOU and shall finalize the MOU no later than September 1, 2022.
- 12.6 The Union shall provide the District with an annual report by June 30 of each year on the implementation of the provisions set forth in this Article and in the Union Educational and Career Development Support MOU. The report shall provide any information requested by the District to assist the District in reporting work-based learning indicator on the State of California's College and Career Dashboard.

ARTICLE 13

EXHIBIT "H"

NON-DISCRIMINATION

- 13.1 The Unions and Contractors shall not discriminate against any employee or applicant for employment because of race, creed, color, sex, sexual orientation, political affiliation, national origin, age, religion, Vietnam veteran or Vietnam Era status, disability as identified in the Americans with Disabilities Act, membership in a labor organization in hiring and dispatching workers for the Project, or any other basis recognized by law. The parties to this Agreement understand and agree that nothing in this Agreement shall supersede or take precedence over any District Board of Education policy or requirement including, but not limited to, the construction contract and general conditions for the Project.
- 13.2 All qualified (as determined by the District and applicable law) contractors and subcontractors may bid and be awarded work on a Project without regard to whether they are otherwise parties to collective bargaining agreements provided they comply with the provisions of this Agreement.

ARTICLE 14

HOURS OF WORK SHIFTS AND HOLIDAYS

- 14.1 The standard workday shall be in accordance with the applicable Master Agreements. Common start times may be established by the Contractor during the standard workday established by the applicable Master Agreements. The standard work week shall be five (5) consecutive days of work commencing on Monday. Nothing herein shall be construed as guaranteeing any employee eight (8) hours of work per day or forty (40) hours of work per week.
- 14.2 Common shifts may be established when considered necessary by the Contractor. The Contractor shall provide at least one week notice to the Council prior to any change in shift time. Any shifts established shall continue for the established work week.
- 14.3 Recognized holidays shall be in accordance with the applicable Master Agreements. Under no circumstances shall any work be performed on Labor Day except in cases of emergency involving life or property. In the event a holiday falls on Saturday, the previous day, Friday, shall be observed as such holiday. In the event a holiday falls on Sunday, the following day, Monday, shall be observed as such holiday. There shall be no paid holidays. If employees are required to work on a holiday, they shall receive the appropriate rate, but in no case shall such overtime rate be more than double the straight time rate.

ARTICLE 15

EXHIBIT "H"

GENERAL PROVISIONS

- 15.1 If any article or provision of this Agreement shall become invalid, inoperative and/or unenforceable by operation of law or by declaration of any competent authority of the executive, legislative, judicial or administrative branches of the federal or state government, the District, the Contractors and the Council shall suspend the operation of such article or provision during the period of its invalidity, and the District and the Council shall negotiate in its place and stead an article or provision that will satisfy the objections to its validity and that, to the greatest extent possible, will be in accord with the intent and purpose of the article or provision in question. The new article or provision negotiated by the District and the Council shall be binding on all parties signatory to this Agreement.
- 15.2 If any article or provision of this Agreement shall be held invalid, inoperative or unenforceable by operation of law, or by any of the above-mentioned tribunals of competent jurisdiction, the remainder of the Agreement or application of such article or provision to persons or circumstances other than to which it has been held invalid, inoperative or unenforceable shall not be affected thereby.
- 15.3 Except as enumerated in this Agreement, all other terms and conditions of employment described in the Master Agreement of the Union having traditional and customary jurisdiction over the Covered Work shall apply.
- 15.4 The provisions of this Agreement shall take precedence over conflicting provisions of any Master Agreement or any other national, area or local collective bargaining agreement, except for all work performed under the NTL Articles of Agreement, the National Stack/Chimney Agreement and the National Cooling Tower Agreement. In addition, all instrument calibration work and loop checking Covered Work shall be performed under the terms of the UA/IBEW Joint National Agreement for Instrument and Control Systems Technicians, and work within the craft jurisdiction of the Elevator Constructors will be performed under the terms of the National Agreements of the International Union of Elevator Constructors. Notwithstanding the provisions of this section, Articles 5, 6 and 9 of this Agreement shall apply to all Covered Work.
- 15.5 Each person executing this Agreement represents and warrants that he or she is authorized to execute this Agreement on behalf of the party or parties indicated.
- 15.6 This Agreement may be executed in any number of counterparts, and each counterpart shall be deemed to be an original document. All executed counterparts together shall constitute one and the same document, and any signature pages may be assembled to form a single original document.
- 15.7 To the fullest extent consistent with the applicable Master Agreement and trust agreement, it is agreed that any liability under this Agreement by District, the Council, a Union, or any other Contractor shall be several and not joint. Any alleged breach of this Agreement by a party shall not affect the rights, liabilities, obligations, and duties among the other parties or between that party and any other party.

EXHIBIT "H"

ARTICLE 16

HELMETS TO HARDHATS

- 16.1 The Contractors and Unions recognize a desire to facilitate the entry into the building and construction trades of veterans and members of the National Guard and Reserves who are interested in careers in the building and construction industry. The Contractors and Unions agree to utilize the services of the Center for Military Recruitment, Assessment and Veterans Employment (hereinafter "Center"), a joint Labor-Management Cooperation Trust Fund, established under the authority of Section 6(b) of the Labor-Management Cooperation Act of 1978, 29 U.S.C. Section 175(a), and Section 302(c)(9) of the Labor-Management Relations Act, 29 U.S.C. Section and a charitable tax exempt organization under Section 501 (c)(3) of the Internal Revenue Code, and the Center's "Helmets to Hardhats" program to serve as a resource for preliminary orientation, assessment of construction aptitude, referral to apprenticeship programs or hiring halls, counseling and mentoring, support network, employment opportunities and other needs as identified by the parties.
- 16.2 The Unions and Contractors agree to coordinate with the Center to create and maintain an integrated database of veterans and members of the National Guard and Reserves interested in working on this Project and of apprenticeship and employment opportunities for this Project. To the extent permitted by law, the Contractors and Unions will give credit to such veterans and members of the National Guard and Reserves for bona fide, provable past experience.

ARTICLE 17

DURATION OF AGREEMENT; MID-TERM ASSESSMENT

- 17.1 This Agreement shall remain in full force and effect for a period of five (5) years from the date approved by the Board of Education on June 9, 2022. Notwithstanding the term of the Agreement as set forth above, the Agreement will continue to apply until the completion of all Covered Work pursuant to Section 2.1 where the initial bid for any Construction Contract for a Project is awarded or approved by the Board on or before the date the Agreement terminates.
- 17.2 At the two-year mark, a mid-term assessment, including mutually agreed upon metrics, shall be reported to the Board.

EXHIBIT "H"

SIGNATURES

Sacramento City Unified School District



Date: 8/5/22

Name: Christine Pritchet

Title: SCUSD Board President

Sacramento-Sierra Building and

Construction Trades Council

DocuSigned by:



B4C87250B34241A...

Date: _____

Name: Kevin Ferreira

Title: Executive Director

Sacramento-Sierra Building and

Construction Trades Council



Date: 7-29-22

Name: Karl Pineo

Title: President

EXHIBIT "H"

Sacramento-Sierra Building and

Construction Trades Council



Name: Todd Schiavo

Title: Vice-President

Date: 8/2/2022

EXHIBIT "H"

DocuSigned by:

8C910C1A0D294D5...

Asbestos Workers Local #16

DocuSigned by:

D48B5A45BA76425...

Bricklayers Local #3

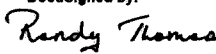
DocuSigned by:

C23CEC6C30BC44A...

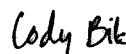
Boilermakers Local #549

DocuSigned by:

4F8B44AA19D47C...

Cement Masons Local #400

DocuSigned by:

C10D2576816641F...

Asbestos, Lead and Mold Laborers Local #67

DocuSigned by:

0D9AD26FD7DFACE...

District Council #16 International Union of Painters & Allied Trades

DocuSigned by:

B9EDEF97DCC4462...

Elevator Constructors Local #8

DocuSigned by:

C0069C1D0CA54AC...

International Brotherhood of Electricians Local #340

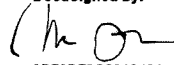
DocuSigned by:

9BF3BF3C801649A...

Sprinkler Fitters Local #669

UNIONS
DocuSigned by:

CD7DE50D9167457...

Iron Workers Local #118

DocuSigned by:

C20514D48D51437...

Laborers Local #185

Operating Engineers Local #3

DocuSigned by:

B85F4751AD06435...

Plasterers & Cement Masons Local #300

DocuSigned by:

18EECB2BF4504BA...

UA of Journeymen & Apprentices of the Plumbing & Pipe Fitting Ind. Local #355

DocuSigned by:

9CC33EC090F84FA...

Plumbers & Pipefitters Local #447

DocuSigned by:

09D284A82D354D7...

Roofers Local #81

DocuSigned by:

73EA33F8D61046A...

Sheet Metal Workers Local #104

DocuSigned by:

BC6F45A38B6746A...

Teamsters Local #150

Northern California Carpenters Regional Council on behalf of itself and its affiliated Local Unions

EXHIBIT "H"

UNIONS

Asbestos Workers Local #6

Laborers Local #185

Bricklayers Local #3

Millwrights Local #102

Boilermakers Local #549

Northern California District Council of Laborers



Carpenters 46 Northern California Counties Conference Board

Operating Engineers Local #3

Cement Masons Local #400

Plasterers & Cement Masons Local #300

District Council #16 International Union of Painters & Allied Trades

Pile Drivers Local #34

District Council of Plasterers & Cement Masons of Northern California

Plumbers & Pipefitters Local #447

Drywall/Latherers Local #9109

Roofers Local #81

International Brotherhood of Electricians Local #340

Sheet Metal Workers Local #104

EXHIBIT "H"

[INTENTIONALLY LEFT BLANK]

EXHIBIT "H"

ATTACHMENT A

PROJECT LABOR AGREEMENT

Nicholas Elementary School New School
Project: Construction & Modernization
Bid Number: #0262-461

AGREEMENT TO BE BOUND

SACRAMENTO CITY UNIFIED SCHOOL DISTRICT

The undersigned hereby certifies and agrees that:

- 1.) It is a Contractor as that term is defined in Section I .7 of the Sacramento City Unified School District Agreement ("Agreement") because it has been, or will be, awarded a contract or subcontract to assign, award or subcontract Covered Work (as defined in Section 2.3) on the Project (as defined in Section 1.9), or to authorize another party to assign, award or subcontract Covered Work, or to perform Covered Work.
- 2.) In consideration of the award of such contract or subcontract, and in further consideration of the promises made in the Agreement and all attachments thereto (a copy of which was received and is hereby acknowledged), it accepts and agrees to be bound by the terms and conditions of the Agreement, together with any and all amendments and supplements now existing, or which are later made thereto.
- 3.) If it performs Covered Work, it will be bound by the legally established trust agreements designated in local master collective bargaining agreements, and hereby authorizes the parties to such local trust agreements to appoint trustees and successor trustee to administer the trust funds, and hereby ratifies and accepts the trustees so appointed as if made by the undersigned.
- 4.) It has no commitments or agreements that would preclude its full and complete compliance with the terms and conditions of the Agreement.
- 5.) It will secure a duly executed Agreement to be Bound, in form identical to this document, from any Contractor(s) at any tier or tiers with which it contracts to assign, award, or subcontract Covered Work, or to authorize another party to assign, award or subcontract Covered Work, or to perform Covered Work, and it will provide a copy of such executed Agreement to be Bound to the Sacramento-Sierra Building & Construction Trades Council within fifteen (15) days of such contracting or subcontracting in accordance with Section 3.2 of the Agreement.

EXHIBIT "H"

DATED: _____

Name of Contractor _____

(Authorized Officer & Title)

(Address)

SUMMARY OF WORK

PART 1 - GENERAL

1.01 RELATED DOCUMENTS AND PROVISIONS

All Contract Documents should be reviewed for applicable provisions related to the provisions in this document, including without limitation:

- A. General Conditions, including, without limitation, Site Access Conditions and Requirements;
- B. Special Conditions.

1.02 SUMMARY OF WORK COVERED BY CONTRACT DOCUMENTS

- A. The Work of this Contract consists of the following:

Selective deferred maintenance necessary to an elementary school campus including scope indicated below as well as Exhibits C, D, E, F, and G. Generally these categories of work include, but are not limited to: asphalt, new roofing and repairs, technology demo, painting (exterior and interior), flooring (carpet & vinyl), acoustical ceiling repairs, door hardware replacement, signage, dry rot repair, drinking fountain conversion to OFCI bottle fillers, ornamental fence, and play equipment.

Included:

- 1. Furnish all labor, material and equipment for all Work shown and/or specified in accordance with the Contract Documents except as excluded below.
- 2. Information provided under "Also Included" points out some items which may be considered less obvious or "unconventional", but which are included in the Scope of Work.
- 3. This Bid Package Description is intended to clarify scope to the Contractor, but is in no way intended to limit scope that is reasonable inferable as being required by the Work included in this description. Work required under the Bid Package may be shown as specified anywhere in the Contract Documents.

Also Included:

- 1. Weather protection during the course of construction
- 2. Temporary barricades, signs as needed.
- 3. Daily and Final Clean-up.
- 4. A full-time superintendent shall be provided.
- 5. All demolition and removal and/or replacement of Work associated with this Bid Package.

6. Assume all paint contains lead and provide properly trained and certified workers as required.
7. Painting of all Building exteriors with the exception of brick surface.
8. Remove and Reinstall of all mini-blinds for painting
9. Finish Details will be provided via addendum
 - a. Color determination may be provided post-bid

Excluded:

1. **HAZMAT Remediation identified in Exhibit B – HAZMAT Survey**
(This scope is anticipated to be complete prior to start of this project.)

1.03 CONTRACTS

- A. Perform the Work under a single, fixed-price Contract.

1.04 WORK BY OTHERS

- A. Work on the Project that will be performed and completed prior to the start of the Work of this Contract:
 - (1) HAZMAT Remediation associated with Exhibit B – HAZMAT Survey
- B. Work on the Project that will be performed by others concurrent with the Work of this Contract:
 - (1) Possibly: New Technology Project

1.05 CODES, REGULATIONS, AND STANDARDS

- A. The codes, regulations, and standards adopted by the state and federal agencies having jurisdiction shall govern minimum requirements for this Project. Where codes, regulations, and standards conflict with the Contract Documents, these conflicts shall be brought to the immediate attention of the District and the Architect.
- B. Codes, regulations, and standards shall be as published effective as of date of bid opening, unless otherwise specified or indicated.

1.06 PROJECT RECORD DOCUMENTS

- A. Contractor shall maintain on Site one set of the following record documents; Contractor shall record actual revisions to the Work:
 - (1) Specifications.
 - (2) Addenda.
 - (3) Change Orders and other modifications to the Contract.
 - (4) Reviewed shop drawings, product data, and samples.

- (5) Manufacturer's certificates.
- B. Contractor shall store Record Documents separate from documents used for construction. Provide files, racks, and secure storage for Record Documents and samples.
- C. Contractor shall record information concurrent with construction progress.
- D. Specifications: Contractor shall legibly mark and record at each product section of the Specifications the description of the actual product(s) installed, including the following:
 - (1) Manufacturer's name and product model and number.
 - (2) Product substitutions or alternates utilized.
 - (3) Changes made by Addenda and Change Orders and written directives.

1.07 EXAMINATION OF EXISTING CONDITIONS

- A. Contractor shall be held to have examined the Project Site and acquainted itself with the conditions of the Site and of the streets or roads approaching the Site.
- B. Prior to commencement of Work, Contractor shall survey the Site and existing buildings and improvements to observe existing damage and defects such as cracks, sags, broken, missing or damaged glazing, other building elements and Site improvements, and other damage.
- C. Should Contractor observe cracks, sags, and other damage to and defects of the Site and adjacent buildings, paving, and other items not indicated in the Contract Documents, Contractor shall immediately report same to the District and the Architect.

1.08 CONTRACTOR'S USE OF PREMISES

- A. If unoccupied and only with District's prior written approval, Contractor may use the building(s) at the Project Site without limitation for its operations, storage, and office facilities for the performance of the Work. If the District chooses to beneficially occupy any building(s), Contractor must obtain the District's written approval for Contractor's use of spaces and types of operations to be performed within the building(s) while so occupied. Contractor's access to the building(s) shall be limited to the areas indicated.
- B. If the space at the Project Site is not sufficient for Contractor's operations, storage, office facilities and/or parking, Contractor shall arrange and pay for any additional facilities needed by Contractor.
- C. Contractor shall not interfere with use of or access to occupied portions of the building(s) or adjacent property.

- D. Contractor shall maintain corridors, stairs, halls, and other exit-ways of building clear and free of debris and obstructions at all times.
- E. No one other than those directly involved in the demolition and construction, or specifically designated by the District or the Architect shall be permitted in the areas of work during demolition and construction activities.
- F. The Contractor shall install the construction fence and maintain that it will be locked when not in use. Keys to this fencing will be provided to the District.

1.09 PROTECTION OF EXISTING STRUCTURES AND UTILITIES

- A. The Drawings show above-grade and below-grade structures, utility lines, and other installations that are known or believed to exist in the area of the Work. Contractor shall locate these existing installations before proceeding with excavation and other operations that could damage same; maintain them in service, where appropriate; and repair damage to them caused by the performance of the Work. Should damage occur to these existing installations, the costs of repair shall be at the Contractor's expense and made to the District's satisfaction.
- B. Contractor shall be alert to the possibility of the existence of additional structures and utilities. If Contractor encounters additional structures and utilities, Contractor will immediately report to the District for disposition of same as indicated in the General Conditions.

1.10 UTILITY SHUTDOWNS AND INTERRUPTIONS

- A. Contractor shall give the District a minimum of three (3) days written notice in advance of any need to shut off existing utility services or to effect equipment interruptions. The District will set exact time and duration for shutdown, and will assist Contractor with shutdown. Work required to re-establish utility services shall be performed by the Contractor.
- B. Contractor shall obtain District's written approval as indicated in the General Conditions in advance of deliveries of material or equipment or other activities that may conflict with District's use of the building(s) or adjacent facilities.

1.11 STRUCTURAL INTEGRITY

- A. Contractor shall be responsible for and supervise each operation and work that could affect structural integrity of various building elements, both permanent and temporary.
- B. Contractor shall include structural connections and fastenings as indicated or required for complete performance of the Work.

PART 2 – PRODUCTS Not Used.

PART 3 – EXECUTION Not Used.

END OF DOCUMENT

ALLOWANCE

PART 1 GENERAL

1.1 SECTION INCLUDES

A. Non-specified work.

1.2 RELATED SECTIONS

A. Document 01 10 00 (Summary of Work)

B. Document 01 29 00 (Payments and Completion)

C. Document 01 32 19 (Submittal Procedures)

1.3 ALLOWANCES

A. Included in the Contract, a stipulated sum/price of

Owner Allowance – 10% of Base Bid

Unforeseen Dry Rot, Structural Conditions Allowance - \$100,000.00

Roofing Repairs Allowance - \$15,000

within the limits set forth in the Contract Documents. This Allowance(s) shall not be utilized without written approval by the District.

B. Contractor's costs, for products, delivery, installation, labor, insurance, payroll, taxes, bonding and equipment rental will be included in Allowance Expenditure Directive authorizing expenditure of funds from this Allowance.

C. Funds will be drawn from Allowance only with District approval evidenced by an Allowance Expenditure Directive.

D. At Contract closeout, funds remaining in Allowance will be credited to District by Change Order.

E. Whenever costs are more than the Allowance, the amount covered by the Allowance will be approved at cost. The Contract Price shall be adjusted by Change Order for amounts in excess of the Allowance.

PART 2 PRODUCTS

Not used.

PART 3 EXECUTION

Not used.

END OF DOCUMENT

PRODUCT OPTIONS AND SUBSTITUTIONS

PART 4 - GENERAL

4.01 RELATED DOCUMENTS AND PROVISIONS

All Contract Documents should be reviewed for applicable provisions related to the provisions in this document, including without limitation:

- A. Instructions to Bidders;
- B. General Conditions, including, without limitation, Substitutions For Specified Items; and
- C. Special Conditions.

4.02 SUBSTITUTIONS OF MATERIALS AND EQUIPMENT

- A. Catalog numbers and specific brands or trade names followed by the designation "or equal" are used in conjunction with material and equipment required by the Specifications to establish the standards of quality, utility, and appearance required. Substitutions which are equal in quality, utility, and appearance to those specified may be reviewed subject to the provisions of the General Conditions.
- B. Wherever more than one manufacturer's product is specified, the first-named product is the basis for the design used in the work and the use of alternative-named manufacturers' products or substitutes may require modifications in that design. If such alternatives are proposed by Contractor and are approved by the District and/or the Architect, Contractor shall assume all costs required to make necessary revisions and modifications of the design resulting from the substitutions requested by the Contractor.
- C. When materials and equipment are specified by first manufacturer's name and product number, second manufacturer's name and "or approved equal," supporting data for the second product, if proposed by Contractor, shall be submitted in accordance with the requirements for substitutions. The District's Board has found and determined that certain item(s) shall be used on this Project based on the purpose(s) indicated pursuant to Public Contract Code section 3400(c). These findings, as well as the products and brand or trade names, have been identified in the Notice to Bidders.
- D. The Contractor will not be allowed to substitute specified items unless the request for substitution is submitted as follows:
 - (1) District must receive any notice of request for substitution of a specified item a minimum of ten (10) calendar days prior to bid opening.

- (2) Within 35 days after the date of the Notice of Award, the Contractor shall submit data substantiating the request(s) for all substitution(s) containing sufficient information to assess acceptability of product or system and impact on Project, including, without limitation, the requirements specified in the Special Conditions and the technical Specifications. Insufficient information shall be grounds for rejection of substitution.
- E. If the District and/or Architect, in reviewing proposed substitute materials and equipment, require revisions or corrections to be made to previously accepted Shop Drawings and supplemental supporting data to be resubmitted, Contractor shall promptly do so. If any proposed substitution is judged by the District and/or Architect to be unacceptable, the specified material or equipment shall be provided.
- F. Samples may be required. Tests required by the District and/or Architect for the determination of quality and utility shall be made at the expense of Contractor, with acceptance of the test procedure first given by the District.
- G. In reviewing the supporting data submitted for substitutions, the District and/or Architect will use for purposes of comparison all the characteristics of the specified material or equipment as they appear in the manufacturer's published data even though all the characteristics may not have been particularly mentioned in the Contract Documents. If more than two (2) submissions of supporting data are required, the cost of reviewing the additional supporting data shall be borne by Contractor, and the District will deduct the costs from the Contract Price. The Contractor shall be responsible for any re-design costs occasioned by District's acceptance and/or approval of any substitute.
- H. The Contractor shall, in the event that a substitute is less costly than that specified, credit the District with one hundred percent (100%) of the net difference between the substitute and the originally specified material. In this event, the Contractor agrees to execute a deductive Change Order to reflect that credit. In the event Contractor furnishes a material, process, or article more expensive than that specified, the difference in the cost of that material, process, or article so furnished shall be borne by Contractor.
- I. In no event shall the District be liable for any increase in Contract Price or Contract Time due to any claimed delay in the evaluation of any proposed substitute or in the acceptance or rejection of any proposed substitute.

PART 5 – PRODUCTS Not Used.

PART 6 – EXECUTION Not Used.

END OF DOCUMENT

DOCUMENT 01 26 00

CHANGES IN THE WORK

CONTRACTOR SHALL COMPLY WITH ALL APPLICABLE PROVISIONS IN THE AGREEMENT, GENERAL CONDITIONS, AND SPECIAL CONDITIONS, IF USED, RELATED TO CHANGES AND/OR REQUESTS FOR CHANGES.

END OF DOCUMENT

DOCUMENT 01 29 00

**APPLICATION FOR PAYMENT AND
CONDITIONAL AND UNCONDITIONAL WAIVER AND RELEASE FORMS**

**CONTRACTOR SHALL COMPLY WITH ALL PROVISIONS IN THE GENERAL
CONDITIONS RELATED TO APPLICATIONS FOR PAYMENT AND/OR PAYMENTS.**

**SACRAMENTO CITY USD
0262-461-CBW-D-M Clayton B. Wire
Deferred Maintenance**

**APPLICATION FOR PAYMENT AND
CONDITIONAL AND UNCONDITIONAL
WAIVER AND RELEASE FORMS
DOCUMENT 01 29 00-1**

**CONDITIONAL WAIVER AND RELEASE
ON PROGRESS PAYMENT
(CIVIL CODE SECTION 8132)**

NOTICE: THIS DOCUMENT WAIVES THE CLAIMANT'S LIEN, STOP PAYMENT NOTICE, AND PAYMENT BOND RIGHTS EFFECTIVE ON RECEIPT OF PAYMENT. A PERSON SHOULD NOT RELY ON THIS DOCUMENT UNLESS SATISFIED THAT THE CLAIMANT HAS RECEIVED PAYMENT.

Name of Claimant: _____

Name of Customer: _____

Job Location: _____

Owner: _____

Through Date: _____

Conditional Waiver and Release

This document waives and releases lien, stop payment notice, and payment bond rights the claimant has for labor and service provided, and equipment and material delivered, to the customer on this job through the Through Date of this document. Rights based upon labor or service provided, or equipment or material delivered, pursuant to a written change order that has been fully executed by the parties prior to the date that this document is signed by the claimant, are waived and released by this document, unless listed as an Exception below. This document is effective only on the claimant's receipt of payment from the financial institution on which the following check is drawn:

Maker of Check: _____

Amount of Check: \$ _____

Check Payable to: _____

Exceptions

This document does not affect any of the following:

- (1) Retentions.
- (2) Extras for which the claimant has not received payment.
- (3) The following progress payments for which the claimant has previously given a conditional waiver and release but has not received payment:

Date(s) of waiver and release: _____

Amount(s) of unpaid progress payment(s): \$ _____

**SACRAMENTO CITY USD
0262-461-CBW-D-M Clayton B. Wire
Deferred Maintenance**

**APPLICATION FOR PAYMENT AND
CONDITIONAL AND UNCONDITIONAL
WAIVER AND RELEASE FORMS
DOCUMENT 01 29 00-2**

- (4) Contract rights, including (A) a right based on rescission, abandonment, or breach of contract, and (B) the right to recover compensation for work not compensated by the payment.

Claimant's Signature: _____

Claimant's Title: _____

Date of Signature: _____

**UNCONDITIONAL WAIVER AND RELEASE
ON PROGRESS PAYMENT
(CIVIL CODE SECTION 8134)**

NOTICE TO CLAIMANT: THIS DOCUMENT WAIVES AND RELEASES LIEN, STOP PAYMENT NOTICE, AND PAYMENT BOND RIGHTS UNCONDITIONALLY AND STATES THAT YOU HAVE BEEN PAID FOR GIVING UP THOSE RIGHTS. THIS DOCUMENT IS ENFORCEABLE AGAINST YOU IF YOU SIGN IT, EVEN IF YOU HAVE NOT BEEN PAID. IF YOU HAVE NOT BEEN PAID, USE A CONDITIONAL WAIVER AND RELEASE FORM.

Name of Claimant: _____

Name of Customer: _____

Job Location: _____

Owner: _____

Through Date: _____

Unconditional Waiver and Release

This document waives and releases lien, stop payment notice, and payment bond rights the claimant has for labor and service provided, and equipment and material delivered, to the customer on this job through the Through Date of this document. Rights based upon labor or service provided, or equipment or material delivered, pursuant to a written change order that has been fully executed by the parties prior to the date that this document is signed by the claimant, are waived and released by this document, unless listed as an Exception below. The claimant has received the following progress payment: \$_____

Exceptions

This document does not affect any of the following:

- (5) Retentions.
- (6) Extras for which the claimant has not received payment.
- (7) Contract rights, including (A) a right based on rescission, abandonment, or breach of contract, and (B) the right to recover compensation for work not compensated by the payment.

Claimant's Signature: _____

Claimant's Title: _____

Date of Signature: _____

**CONDITIONAL WAIVER AND RELEASE
ON FINAL PAYMENT
(CIVIL CODE SECTION 8136)**

NOTICE: THIS DOCUMENT WAIVES THE CLAIMANT'S LIEN, STOP PAYMENT NOTICE, AND PAYMENT BOND RIGHTS EFFECTIVE ON RECEIPT OF PAYMENT. A PERSON SHOULD NOT RELY ON THIS DOCUMENT UNLESS SATISFIED THAT THE CLAIMANT HAS RECEIVED PAYMENT.

Name of Claimant: _____

Name of Customer: _____

Job Location: _____

Owner: _____

Conditional Waiver and Release

This document waives and releases lien, stop payment notice, and payment bond rights the claimant has for labor and service provided, and equipment and material delivered, to the customer on this job. Rights based upon labor or service provided, or equipment or material delivered, pursuant to a written change order that has been fully executed by the parties prior to the date that this document is signed by the claimant, are waived and released by this document, unless listed as an Exception below. This document is effective only on the claimant's receipt of payment from the financial institution on which the following check is drawn:

Maker of Check: _____

Amount of Check: \$ _____

Check Payable to: _____

Exceptions

This document does not affect any of the following: _____

Disputed claims for extras in the amount of: \$ _____

Claimant's Signature: _____

Claimant's Title: _____

Date of Signature: _____

**UNCONDITIONAL WAIVER AND RELEASE
ON FINAL PAYMENT
(CIVIL CODE SECTION 8138)**

NOTICE TO CLAIMANT: THIS DOCUMENT WAIVES AND RELEASES LIEN, STOP PAYMENT NOTICE, AND PAYMENT BOND RIGHTS UNCONDITIONALLY AND STATES THAT YOU HAVE BEEN PAID FOR GIVING UP THOSE RIGHTS. THIS DOCUMENT IS ENFORCEABLE AGAINST YOU IF YOU SIGN IT, EVEN IF YOU HAVE NOT BEEN PAID. IF YOU HAVE NOT BEEN PAID, USE A CONDITIONAL WAIVER AND RELEASE FORM.

Name of Claimant: _____

Name of Customer: _____

Job Location: _____

Owner: _____

Unconditional Waiver and Release

This document waives and releases lien, stop payment notice, and payment bond rights the claimant has for all labor and service provided, and equipment and material delivered, to the customer on this job. Rights based upon labor or service provided, or equipment or material delivered, pursuant to a written change order that has been fully executed by the parties prior to the date that this document is signed by the claimant, are waived and released by this document, unless listed as an Exception below. The claimant has been paid in full.

Exceptions

This document does not affect any of the following: _____

Disputed claims for extras in the amount of: \$_____

Claimant's Signature: _____

Claimant's Title: _____

Date of Signature: _____

PROJECT MEETINGS

PART 7 – GENERAL

7.01 RELATED DOCUMENTS AND PROVISIONS:

All Contract Documents should be reviewed for applicable provisions related to the provisions in this document, including without limitation:

- A. General Conditions; and
- B. Special Conditions.

7.02 PROGRESS MEETINGS:

- A. Contractor shall schedule and hold regular weekly progress meetings after a minimum of one week's prior written notice of the meeting date and time to all Invitees as indicated below.
- B. Location: Contractor's field office.
- C. The Contractor shall notify and invite the following entities ("Invitees"):
 - (1) District Representative.
 - (2) Contractor.
 - (3) Contractor's Project Manager.
 - (4) Contractor's Superintendent.
 - (5) Subcontractors, as appropriate to the agenda of the meeting.
 - (6) Suppliers, as appropriate to the agenda of the meeting.
 - (7) Construction Manager, if any.
 - (8) Architect
 - (9) Engineer(s), if any and as appropriate to the agenda of the meeting.
 - (10) Others, as appropriate to the agenda of the meeting.
- D. The District's and/or the Architect's Consultants will attend at their discretion, in response to the agenda.
- E. The District representative, the Construction Manager, and/or another District Agent shall take and distribute meeting notes to attendees and other concerned parties. If exceptions are taken to anything in the meeting notes,

those exceptions shall be stated in writing to the District within five (5) working days following District's distribution of the meeting notes.

7.03 PRE-INSTALLATION/PERFORMANCE MEETING:

- A. Contractor shall schedule a meeting prior to the start of each of the following portions of the Work: asphalt, roofing, and tech. Contractor shall invite all Invitees to this meeting, and others whose work may affect or be affected by the quality of the cutting and patching work.
- B. Contractor shall review in detail prior to this meeting, the manufacturer's requirements and specifications, applicable portions of the Contract Documents, Shop Drawings, and other submittals, and other related work. At this meeting, invitees shall review and resolve conflicts, incompatibilities, or inadequacies discovered or anticipated.
- C. Contractor shall review in detail Project conditions, schedule, requirements for performance, application, installation, and quality of completed Work, and protection of adjacent Work and property.
- D. Contractor shall review in detail means of protecting the completed Work during the remainder of the construction period.

PART 8 - PRODUCTS Not Used.

PART 9 - EXECUTION Not Used.

END OF DOCUMENT

SCHEDULING OF WORK

PART 1 – GENERAL

1.01 RELATED DOCUMENTS AND PROVISIONS

All Contract Documents should be reviewed for applicable provisions related to the provisions in this document, including without limitation:

- A. General Conditions;
- B. Special Conditions;
- C. Summary of Work; and
- D. Submittals.

1.02 SECTION INCLUDES

- A. Scheduling of Work under this Contract shall be performed by Contractor in accordance with requirements of this Section.
 - (1) Development of schedule, cost and resource loading of the schedule, monthly payment requests, and project status reporting requirements of the Contract shall employ computerized Critical Path Method ("CPM") scheduling ("CPM Schedule").
 - (2) CPM Schedule shall be cost loaded based on Schedule of Values as approved by District.
 - (3) Submit schedules and reports as specified in the General Conditions.
- B. Upon Award of Contract, Contractor shall immediately commence development of Initial and Original CPM Schedules to ensure compliance with CPM Schedule submittal requirements.

1.03 CONSTRUCTION SCHEDULE

- A. Within ten (10) days of issuance of the Notice to Proceed and before request for first progress payment, the Contractor shall prepare and submit to the Project Manager a construction progress schedule conforming to the Milestone Schedule below.
- B. The Construction Schedule shall be continuously updated, and an updated schedule shall be submitted with each application for progress payment. Each revised schedule shall indicate the work actually accomplished during the previous period and the schedule for completion of the remaining work.

C. Milestone Schedule:

Preliminary Construction Schedule

Anticipated Notice of Intent to Award (NOITA)	01/31/2023
Anticipated Board Approval of Construction Contract	02/16/2023
Anticipated Notice to Proceed (NTP)	02/17/2023

Site Construction Schedule

Anticipated completion HAZMAT Remediation by Others	03/03/2023
Mobilization and Start of Construction	03/06/2023
Construction	03/06/2023 – 05/05/2023
Close-Out Phase	05/06/2023 – 05/19/2023
Project Time of Completion	05/19/2023

1.04 QUALIFICATIONS

- A. Contractor shall employ experienced scheduling personnel qualified to use the latest version of [i.e., Primavera Project Planner]. Experience level required is set forth below. Contractor may employ such personnel directly or may employ a consultant for this purpose.
 - (1) The written statement shall identify the individual who will perform CPM scheduling.
 - (2) Capability and experience shall be verified by description of construction projects on which individual has successfully applied computerized CPM.
 - (3) Required level of experience shall include at least two (2) projects of similar nature and scope with value not less than three fourths ($\frac{3}{4}$) of the Total Bid Price of this Project. The written statement shall provide contact persons for referenced projects with current telephone and address information.
- B. District reserves the right to approve or reject Contractor’s scheduler or consultant at any time. District reserves the right to refuse replacing of Contractor’s scheduler or consultant, if District believes replacement will negatively affect the scheduling of Work under this Contract.

1.05 GENERAL

- A. Progress Schedule shall be based on and incorporate milestone and completion dates specified in Contract Documents.
- B. Overall time of completion and time of completion for each milestone shown on Progress Schedule shall adhere to times in the Contract, unless an earlier (advanced) time of completion is requested by Contractor and agreed to by District. Any such agreement shall be formalized by a Change Order.

- (1) District is not required to accept an early completion schedule, i.e., one that shows an earlier completion date than the Contract Time.
 - (2) Contractor shall not be entitled to extra compensation in event agreement is reached on an earlier completion schedule and Contractor completes its Work, for whatever reason, beyond completion date shown in its early completion schedule but within the Contract Time.
 - (3) A schedule showing the work completed in less than the Contract Time, and that has been accepted by District, shall be considered to have Project Float. The Project Float is the time between the scheduled completion of the work and the Completion Date. Project Float is a resource available to both District and the Contractor.
- C. Ownership Project Float: Neither the District nor Contractor owns Project Float. The Project owns the Project Float. As such, liability for delay of the Completion Date rests with the party whose actions, last in time, actually cause delay to the Completion Date.
- (1) For example, if Party A uses some, but not all of the Project Float and Party B later uses remainder of the Project Float as well as additional time beyond the Project Float, Party B shall be liable for the time that represents a delay to the Completion Date.
 - (2) Party A would not be responsible for the time since it did not consume the entire Project Float and additional Project Float remained; therefore, the Completion Date was unaffected by Party A.
- D. Progress Schedule shall be the basis for evaluating job progress, payment requests, and time extension requests. Responsibility for developing Contract CPM Schedule and monitoring actual progress as compared to Progress Schedule rests with Contractor.
- E. Failure of Progress Schedule to include any element of the Work, or any inaccuracy in Progress Schedule, will not relieve Contractor from responsibility for accomplishing the Work in accordance with the Contract. District's acceptance of schedule shall be for its use in monitoring and evaluating job progress, payment requests, and time extension requests and shall not, in any manner, impose a duty of care upon District, or act to relieve Contractor of its responsibility for means and methods of construction.
- F. Software: Use District Preferred Project Planning Software. Such software shall be compatible with Windows operating system. Contractor shall transmit contract file to District on compact disk at times requested by District.
- G. Transmit each item under the form approved by District.
- (1) Identify Project with District Contract number and name of Contractor.
 - (2) Provide space for Contractor's approval stamp and District's review stamps.

- (3) Submittals received from sources other than Contractor will be returned to the Contractor without District's review.

1.06 INITIAL CPM SCHEDULE

- A. Initial CPM Schedule submitted for review at the pre-construction conference shall serve as Contractor's schedule for up to ninety (90) calendar days after the Notice to Proceed.
- B. Indicate detailed plan for the Work to be completed in first ninety (90) days of the Contract; details of planned mobilization of plant and equipment; sequence of early operations; procurement of materials and equipment. Show Work beyond ninety (90) calendar days in summary form.
- C. Initial CPM Schedule shall be time scaled.
- D. Initial CPM Schedule shall be cost and resource loaded. Accepted cost and resource loaded schedule will be used as basis for monthly progress payments until acceptance of the Original CPM Schedule. Use of Initial CPM Schedule for progress payments shall not exceed ninety (90) calendar days.
- E. District and Contractor shall meet to review and discuss the Initial CPM Schedule within seven (7) calendar days after it has been submitted to District.
 - (1) District's review and comment on the schedule shall be limited to Contract conformance (with sequencing, coordination, and milestone requirements).
 - (2) Contractor shall make corrections to schedule necessary to comply with Contract requirements and shall adjust schedule to incorporate any missing information requested by District. Contractor shall resubmit Initial CPM Schedule if requested by District.
- F. If, during the first ninety (90) days after Notice to Proceed, the Contractor is of the opinion that any of the Work included on its Initial CPM Schedule has been impacted, the Contractor shall submit to District a written Time Impact Evaluation ("TIE") in accordance with Article 1.12 of this Section. The TIE shall be based on the most current update of the Initial CPM Schedule.

1.07 ORIGINAL CPM SCHEDULE

- A. Submit a detailed proposed Original CPM Schedule presenting an orderly and realistic plan for completion of the Work in conformance with requirements as specified herein.
- B. Progress Schedule shall include or comply with following requirements:
 - (1) Time scaled, cost and resource (labor and major equipment) loaded CPM schedule.

- (2) No activity on schedule shall have duration longer than fifteen (15) work days, with exception of submittal, approval, fabrication and procurement activities, unless otherwise approved by District.
 - (a) Activity durations shall be total number of actual work days required to perform that activity.
- (3) The start and completion dates of all items of Work, their major components, and milestone completion dates, if any.
- (4) District furnished materials and equipment, if any, identified as separate activities.
- (5) Activities for maintaining Project Record Documents.
- (6) Dependencies (or relationships) between activities.
- (7) Processing/approval of submittals and shop drawings for all material and equipment required per the Contract. Activities that are dependent on submittal acceptance or material delivery shall not be scheduled to start earlier than expected acceptance or delivery dates.
 - (a) Include time for submittals, re-submittals and reviews by District. Coordinate with accepted schedule for submission of Shop Drawings, samples, and other submittals.
 - (b) Contractor shall be responsible for all impacts resulting from re-submittal of Shop Drawings and submittals.
- (8) Procurement of major equipment, through receipt and inspection at jobsite, identified as separate activity.
 - (a) Include time for fabrication and delivery of manufactured products for the Work.
 - (b) Show dependencies between procurement and construction.
- (9) Activity description; what Work is to be accomplished and where.
- (10) The total cost of performing each activity shall be total of labor, material, and equipment, excluding overhead and profit of Contractor. Overhead and profit of the General Contractor shall be shown as a separate activity in the schedule. Sum of cost for all activities shall equal total Contract value.
- (11) Resources required (labor and major equipment) to perform each activity.
- (12) Responsibility code for each activity corresponding to Contractor or Subcontractor responsible for performing the Work.

- (13) Identify the activities which constitute the controlling operations or critical path. No more than twenty-five (25%) of the activities shall be critical or near critical. Near critical is defined as float in the range of one (1) to (10) days.
 - (14) Twenty (20) workdays for developing punch list(s), completion of punch-list items, and final clean up for the Work or any designated portion thereof. No other activities shall be scheduled during this period.
 - (15) Interface with the work of other contractors, District, and agencies such as, but not limited to, utility companies.
 - (16) Show detailed Subcontractor Work activities. In addition, furnish copies of Subcontractor schedules upon which CPM was built.
 - (a) Also furnish for each Subcontractor, as determined by District, submitted on Subcontractor letterhead, a statement certifying that Subcontractor concurs with Contractor's Original CPM Schedule and that Subcontractor's related schedules have been incorporated, including activity duration, cost and resource loading.
 - (b) Subcontractor schedules shall be independently derived and not a copy of Contractor's schedule.
 - (c) In addition to Contractor's schedule and resource loading, obtain from electrical, mechanical, and plumbing Subcontractors, and other Subcontractors as required by District, productivity calculations common to their trades, such as units per person day, feet of pipe per day per person, feet of wiring per day per person, and similar information.
 - (d) Furnish schedule for Contractor/Subcontractor CPM schedule meetings which shall be held prior to submission of Original CPM schedule to District. District shall be permitted to attend scheduled meetings as an observer.
 - (17) Activity durations shall be in Work days.
 - (18) Submit with the schedule a list of anticipated non-Work days, such as weekends and holidays. The Progress Schedule shall exclude in its Work day calendar all non-Work days on which Contractor anticipates critical Work will not be performed.
- C. Original CPM Schedule Review Meeting: Contractor shall, within sixty (60) days from the Notice to Proceed date, meet with District to review the Original CPM Schedule submittal.
- (1) Contractor shall have its Project Manager, Project Superintendent, Project Scheduler, and key Subcontractor representatives, as required

by District, in attendance. The meeting will take place over a continuous one (1) day period.

- (2) District's review will be limited to submittal's conformance to Contract requirements including, but not limited to, coordination requirements. However, review may also include:
 - (a) Clarifications of Contract Requirements.
 - (b) Directions to include activities and information missing from submittal.
 - (c) Requests to Contractor to clarify its schedule.
- (3) Within five (5) days of the Schedule Review Meeting, Contractor shall respond in writing to all questions and comments expressed by District at the Meeting.

1.08 ADJUSTMENTS TO CPM SCHEDULE

- A. Adjustments to Original CPM Schedule: Contractor shall have adjusted the Original CPM Schedule submittal to address all review comments from original CPM Schedule review meeting and resubmit network diagrams and reports for District's review.
 - (1) District, within ten (10) days from date that Contractor submitted the revised schedule, will either:
 - (a) Accept schedule and cost and resource loaded activities as submitted, or
 - (b) Advise Contractor in writing to review any part or parts of schedule which either do not meet Contract requirements or are unsatisfactory for District to monitor Project's progress, resources, and status or evaluate monthly payment request by Contractor.
 - (2) District may accept schedule with conditions that the first monthly CPM Schedule update be revised to correct deficiencies identified.
 - (3) When schedule is accepted, it shall be considered the "Original CPM Schedule" which will then be immediately updated to reflect the current status of the work.
 - (4) District reserves right to require Contractor to adjust, add to, or clarify any portion of schedule which may later be discovered to be insufficient for monitoring of Work or approval of partial payment requests. No additional compensation will be provided for such adjustments, additions, or clarifications.
- B. Acceptance of Contractor's schedule by District will be based solely upon schedule's compliance with Contract requirements.

- (1) By way of Contractor assigning activity durations and proposing sequence of Work, Contractor agrees to utilize sufficient and necessary management and other resources to perform work in accordance with the schedule.
 - (2) Upon submittal of schedule update, updated schedule shall be considered "current" CPM Schedule.
 - (3) Submission of Contractor's schedule to District shall not relieve Contractor of total responsibility for scheduling, sequencing, and pursuing Work to comply with requirements of Contract Documents, including adverse effects such as delays resulting from ill-timed Work.
- C. Submittal of Original CPM Schedule, and subsequent schedule updates, shall be understood to be Contractor's representation that the Schedule meets requirements of Contract Documents and that Work shall be executed in sequence indicated on the schedule.
- D. Contractor shall distribute Original CPM Schedule to Subcontractors for review and written acceptance, which shall be noted on Subcontractors' letterheads to Contractor and transmitted to District for the record.

1.09 MONTHLY CPM SCHEDULE UPDATE SUBMITTALS

- A. Following acceptance of Contractor's Original CPM Schedule, Contractor shall monitor progress of Work and adjust schedule each month to reflect actual progress and any anticipated changes to planned activities.
- (1) Each schedule update submitted shall be complete, including all information requested for the Original CPM Schedule submittal.
 - (2) Each update shall continue to show all Work activities including those already completed. These completed activities shall accurately reflect "as built" information by indicating when activities were actually started and completed.
- B. A meeting will be held on approximately the twenty-fifth (25th) of each month to review the schedule update submittal and progress payment application.
- (1) At this meeting, at a minimum, the following items will be reviewed: Percent (%) complete of each activity; Time Impact Evaluations for Change Orders and Time Extension Request; actual and anticipated activity sequence changes; actual and anticipated duration changes; and actual and anticipated Contractor delays.
 - (2) These meetings are considered a critical component of overall monthly schedule update submittal and Contractor shall have appropriate personnel attend. At a minimum, these meetings shall be attended by Contractor's General Superintendent and Scheduler.

- (3) Contractor shall plan on the meeting taking no less than four (4) hours.
- C. Within five (5) working days after monthly schedule update meeting, Contractor shall submit the updated CPM Schedule update.
- D. Within five (5) work days of receipt of above noted revised submittals, District will either accept or reject monthly schedule update submittal.
 - (1) If accepted, percent (%) complete shown in monthly update will be basis for Application for Payment by the Contractor. The schedule update shall be submitted as part of the Contractor's Application for Payment.
 - (2) If rejected, update shall be corrected and resubmitted by Contractor before the Application for Payment is submitted.
- E. Neither updating, changing or revising of any report, curve, schedule, or narrative submitted to District by Contractor under this Contract, nor District's review or acceptance of any such report, curve, schedule or narrative shall have the effect of amending or modifying in any way the Completion Date or milestone dates or of modifying or limiting in any way Contractor's obligations under this Contract.

1.10 SCHEDULE REVISIONS

- A. Updating the Schedule to reflect actual progress shall not be considered revisions to the Schedule. Since scheduling is a dynamic process, revisions to activity durations and sequences are expected on a monthly basis.
- B. To reflect revisions to the Schedule, the Contractor shall provide District with a written narrative with a full description and reasons for each Work activity revised. For revisions affecting the sequence of work, the Contractor shall provide a schedule diagram which compares the original sequence to the revised sequence of work. The Contractor shall provide the written narrative and schedule diagram for revisions two (2) working days in advance of the monthly schedule update meeting.
- C. Schedule revisions shall not be incorporated into any schedule update until the revisions have been reviewed by District. District may request further information and justification for schedule revisions and Contractor shall, within three (3) days, provide District with a complete written narrative response to District's request.
- D. If the Contractor's revision is still not accepted by District, and the Contractor disagrees with District's position, the Contractor has seven (7) calendar days from receipt of District's letter rejecting the revision to provide a written narrative providing full justification and explanation for the revision. The Contractor's failure to respond in writing within seven (7) calendar days of District's written rejection of a schedule revision shall be contractually interpreted as acceptance of District's position, and the Contractor waives its rights to subsequently dispute or file a claim regarding District's position.

- E. At District's discretion, the Contractor can be required to provide Subcontractor certifications of performance regarding proposed schedule revisions affecting said Subcontractors.

1.11 RECOVERY SCHEDULE

- A. If the Schedule Update shows a completion date twenty-one (21) calendar days beyond the Contract Completion Date, or individual milestone completion dates, the Contractor shall submit to District the proposed revisions to recover the lost time within seven (7) calendar days. As part of this submittal, the Contractor shall provide a written narrative for each revision made to recapture the lost time. If the revisions include sequence changes, the Contractor shall provide a schedule diagram comparing the original sequence to the revised sequence of work.
- B. The revisions shall not be incorporated into any schedule update until the revisions have been reviewed by District.
- C. If the Contractor's revisions are not accepted by District, District and the Contractor shall follow the procedures in paragraph 1.09.C, 1.09.D and 1.09.E above.
- D. At District's discretion, the Contractor can be required to provide Subcontractor certifications for revisions affecting said Subcontractors.

1.12 TIME IMPACT EVALUATION ("TIE") FOR CHANGE ORDERS, AND OTHER DELAYS

- A. When Contractor is directed to proceed with changed Work, the Contractor shall prepare and submit within fourteen (14) calendar days from the Notice to Proceed a TIE which includes both a written narrative and a schedule diagram depicting how the changed Work affects other schedule activities. The schedule diagram shall show how the Contractor proposes to incorporate the changed Work in the schedule and how it impacts the current schedule-update critical path. The Contractor is also responsible for requesting time extensions based on the TIE's impact on the critical path. The diagram must be tied to the main sequence of schedule activities to enable District to evaluate the impact of changed Work to the scheduled critical path.
- B. Contractor shall be required to comply with the requirements of Paragraph 1.09.A for all types of delays such as, but not limited to, Contractor/Subcontractor delays, adverse weather delays, strikes, procurement delays, fabrication delays, etc.
- C. Contractor shall be responsible for all costs associated with the preparation of TIEs, and the process of incorporating them into the current schedule update. The Contractor shall provide District with four (4) copies of each TIE.
- D. Once agreement has been reached on a TIE, the Contract Time will be adjusted accordingly. If agreement is not reached on a TIE, the Contract Time may be extended in an amount District allows, and the Contractor may submit a claim for additional time claimed by contractor.

1.13 TIME EXTENSIONS

- A. The Contractor is responsible for requesting time extensions for time impacts that, in the opinion of the Contractor, impact the critical path of the current schedule update. Notice of time impacts shall be given in accord with the General Conditions.
- B. Where an event for which District is responsible impacts the projected Completion Date, the Contractor shall provide a written mitigation plan, including a schedule diagram, which explains how (e.g., increase crew size, overtime, etc.) the impact can be mitigated. The Contractor shall also include a detailed cost breakdown of the labor, equipment, and material the Contractor would expend to mitigate District-caused time impact. The Contractor shall submit its mitigation plan to District within fourteen (14) calendar days from the date of discovery of the impact. The Contractor is responsible for the cost to prepare the mitigation plan.
- C. Failure to request time, provide TIE, or provide the required mitigation plan will result in Contractor waiving its right to a time extension and cost to mitigate the delay.
- D. No time will be granted under this Contract for cumulative effect of changes.
- E. District will not be obligated to consider any time extension request unless the Contractor complies with the requirements of Contract Documents.
- F. Failure of the Contractor to perform in accordance with the current schedule update shall not be excused by submittal of time extension requests.
- G. If the Contractor does not submit a TIE within the required fourteen (14) calendar days for any issue, it is mutually agreed that the Contractor does not require a time extension for said issue.

1.14 SCHEDULE REPORTS

- A. Submit four (4) copies of the following reports with the Initial CPM Schedule, the Original CPM Schedule, and each monthly update.
- B. Required Reports:
 - (1) Two activity listing reports: one sorted by activity number and one by total Project Float. These reports shall also include each activity's early/late and actual start and finish dates, original and remaining duration, Project Float, responsibility code, and the logic relationship of activities.
 - (2) Cost report sorted by activity number including each activity's associated cost, percentage of Work accomplished, earned value- to date, previous payments, and amount earned for current update period.

- (3) Schedule plots presenting time-scaled network diagram showing activities and their relationships with the controlling operations or critical path clearly highlighted.
- (4) Cash flow report calculated by early start, late start, and indicating actual progress. Provide an exhibit depicting this information in graphic form.
- (5) Planned versus actual resource (i.e., labor) histogram calculated by early start and late start.

C. Other Reports:

In addition to above reports, District may request, from month to month, any two of the following reports. Submit four (4) copies of all reports.

- (1) Activities by early start.
- (2) Activities by late start.
- (3) Activities grouped by Subcontractors or selected trades.
- (4) Activities with scheduled early start dates in a given time frame, such as fifteen (15) or thirty (30) day outlook.

D. Furnish District with report files on compact disks containing all schedule files for each report generated.

1.15 PROJECT STATUS REPORTING

- A. In addition to submittal requirements for CPM scheduling identified in this Section, Contractor shall provide a monthly project status report (i.e., written narrative report) to be submitted in conjunction with each CPM Schedule as specified herein. Status reporting shall be in form specified below.
- B. Contractor shall prepare monthly written narrative reports of status of Project for submission to District. Written status reports shall include:
- (1) Status of major Project components (percent (%) complete, amount of time ahead or behind schedule) and an explanation of how Project will be brought back on schedule if delays have occurred.
 - (2) Progress made on critical activities indicated on CPM Schedule.
 - (3) Explanations for any lack of work on critical path activities planned to be performed during last month.
 - (4) Explanations for any schedule changes, including changes to logic or to activity durations.
 - (5) List of critical activities scheduled to be performed next month.

- (6) Status of major material and equipment procurement.
- (7) Any delays encountered during reporting period.
- (8) Contractor shall provide printed report indicating actual versus planned resource loading for each trade and each activity. This report shall be provided on weekly and monthly basis.
 - (a) Actual resource shall be accumulated in field by Contractor, and shall be as noted on Contractor's daily reports. These reports will be basis for information provided in computer-generated monthly and weekly printed reports.
 - (b) Contractor shall explain all variances and mitigation measures.
- (9) Contractor may include any other information pertinent to status of Project. Contractor shall include additional status information requested by District at no additional cost.
- (10) Status reports, and the information contained therein, shall not be construed as claims, notice of claims, notice of delay, or requests for changes or compensation.

1.16 WEEKLY SCHEDULE REPORT

At the Weekly Progress Meeting, the Contractor shall provide and present a time-scaled three (3) week look-ahead schedule that is based and correlated by activity number to the current schedule (i.e., Initial, Original CPM, or Schedule Update).

1.17 DAILY CONSTRUCTION REPORTS

On a daily basis, Contractor shall submit a daily activity report to District for each workday, including weekends and holidays when worked. Contractor shall develop the daily construction reports on a computer-generated database capable of sorting daily Work, manpower, and man-hours by Contractor, Subcontractor, area, sub-area, and Change Order Work. Upon request of District, furnish computer disk of this data base. Obtain District's written approval of daily construction report data base format prior to implementation. Include in report:

- A. Project name and Project number.
- B. Contractor's name and address.
- C. Weather, temperature, and any unusual site conditions.
- D. Brief description and location of the day's scheduled activities and any special problems and accidents, including Work of Subcontractors. Descriptions shall be referenced to CPM scheduled activities.
- E. Worker quantities for its own Work force and for Subcontractors of any tier.
- F. Equipment, other than hand tools, utilized by Contractor and Subcontractors.

PART 2 – PRODUCTS Not Used.

PART 3 - EXECUTION Not Used.

END OF DOCUMENT

SUBMITTALS

PART 4 - GENERAL

4.01 RELATED DOCUMENTS AND PROVISIONS:

All Contract Documents should be reviewed for applicable provisions related to the provisions in this document, including without limitation:

- A. General Conditions, including, without limitation, Contractor's Submittals and Schedules, Drawings and Specifications;
- B. Special Conditions.

4.02 SECTION INCLUDES:

- A. Definitions:
 - (1) Shop Drawings and Product Data are as indicated in the General Conditions and include, but are not limited to, fabrication, erection, layout and setting drawings, formwork and falsework drawings, manufacturers' standard drawings, descriptive literature, catalogues, brochures, performance and test data, wiring and control diagrams. In addition, there are other drawings and descriptive data pertaining to materials, equipment, piping, duct and conduit systems, and methods of construction as may be required to show that the materials, equipment or systems and all positions conform to the requirement of the Contract Documents, including, without limitation, the Drawings.
 - (2) "Manufactured" applies to standard units usually mass-produced; "fabricated" means specifically assembled or made out of selected materials to meet design requirements. Shop Drawings shall establish the actual detail of manufactured or fabricated items, indicated proper relation to adjoining work and amplify design details of mechanical and electrical equipment in proper relation to physical spaces in the structure.
 - (3) Manufacturer's Instructions: Where any item of Work is required by the Contract Documents to be furnished, installed, or performed, at a minimum, in accordance with a specified product manufacturer's instructions, the Contractor shall procure and distribute copies of these to the District, the Architect, and all other concerned parties and shall furnish, install, or perform the work, at a minimum, in accordance with those instructions.

- B. Samples, Shop Drawings, Product Data, and other items as specified, in accordance with the following requirements:
- (1) Contractor shall submit all Shop Drawings, Product Data, and Samples to the District, the Architect, the Project Inspector, and the Construction Manager.
 - (2) Contractor shall comply with all time frames herein and in the General Conditions and, in any case, shall submit required information in sufficient time to permit proper consideration and action before ordering any materials or items represented by such Shop Drawings, Product Data, and/or Samples.
 - (3) Contractor shall allow sufficient time so that no delay occurs due to required lead time in ordering or delivery of any item to the Site. Contractor shall be responsible for any delay in progress of Work due to its failure to observe these requirements.
 - (4) Time for completion of Work shall not be extended on account of Contractor's failure to promptly submit Shop Drawings, Product Data, and/or Samples.
 - (5) Reference numbers on Shop Drawings shall have Architectural and/or Engineering Contract Drawings reference numbers for details, sections, and "cuts" shown on Shop Drawings. These reference numbers shall be in addition to any numbering system that Contractor chooses to use or has adopted as standard.
 - (6) When the magnitude or complexity of submittal material prevents a complete review within the stated time frame, Contractor shall make this submittal in increments to avoid extended delays.
 - (7) Contractor shall certify on submittals for review that submittals conform to Contract requirements. Also certify that Contractor-furnished equipment can be installed in allocated space. In event of any variance, Contractor shall specifically state in transmittal and on Shop Drawings, portions vary and require approval of a substitute. Submittals shall not be used as a means of requesting a substitution.
 - (8) Unless specified otherwise, sampling, preparation of samples, and tests shall be in accordance with the latest standard of the American Society for Testing and Materials.
 - (9) Upon demand by Architect or District, Contractor shall submit samples of materials and/or articles for tests or examinations and consideration before Contractor incorporates same in Work. Contractor shall be solely responsible for delays due to sample(s) not being submitted in time to allow for tests. Acceptance or rejection will be expressed in writing. Work shall be equal to approved samples in every respect. Samples that are of value after testing will remain the property of Contractor.

- C. Submittal Schedule:
- (1) Contractor shall prepare its proposed submittal schedule that is coordinated with the proposed construction schedule and submit both to the District within ten (10) days after the date of the Notice to Proceed. Contractor's proposed schedules shall become the Project Construction Schedule and the Project Submittal Schedule after each is approved by the District.
 - (2) Contractor is responsible for all lost time should the initial submittal be rejected, marked "revise and resubmit", etc.
 - (3) All Submittals shall be forwarded to the District by the date indicated on the approved Submittal Schedule, unless an earlier date is necessary to maintain the Construction Schedule, in which case those Submittals shall be forwarded to the District so as not to delay the Construction Schedule.
 - (4) Contractor may be assessed \$100 a day for each day it is late in submitting a shop drawing or sample. No extensions of time will be granted to Trade Contractor or any Subcontractor because of its failure to have shop drawings and samples submitted in accordance with the Schedule.

4.03 SHOP DRAWINGS:

- A. Contractor shall submit one reproducible transparency and six (6) opaque reproductions. The District will review and return the reproducible copy and one (1) opaque reproduction to Contractor.
- B. Before commencing installation of any Work, the Contractor shall submit and receive approval of all drawings, descriptive data, and material list(s) as required to accomplish Work.
- C. Review of Shop Drawings is regarded as a service to assist Contractor and in all cases original Contract Documents shall take precedence as outlined under General Conditions.
- D. No claim for extra time or payment shall be based on work shown on Shop Drawings unless the claim is (1) noted on Contractor's transmittal letter accompanying Shop Drawings and (2) Contractor has complied with all applicable provisions of the General Conditions, including, without limitation, provisions regarding changes and payment, and all required written approvals.
- E. District shall not review Shop Drawings for quantities of materials or number of items supplied.
- F. District's and/or Architect's review of Shop Drawing will be general. District and/or Architect review does not relieve Contractor of responsibility for dimensions, accuracy, proper fitting, construction of Work, furnishing of materials, or Work required by Contract Documents and not indicated on

Shop Drawings. The District's and/or Architect's review of Shop Drawings is not to be construed as approving departures from Contract Documents.

- G. Review of Shop Drawings and Schedules does not relieve Contractor from responsibility for any aspect of those Drawings or Schedules that is a violation of local, County, State, or Federal laws, rules, ordinances, or rules and regulations of commissions, boards, or other authorities or utilities having jurisdiction.
- H. Before submitting Shop Drawings for review, Contractor shall check Shop Drawings of its subcontractors for accuracy and confirm that all Work contiguous with and having bearing on other work shown on Shop Drawings is accurately drawn and in conformance with Contract Documents.
- I. Submitted drawings and details must bear stamp of approval of Contractor:
 - (1) Stamp and signature shall clearly certify that Contractor has checked Shop Drawings for compliance with Drawings.
 - (2) If Contractor submits a Shop Drawing without an executed stamp of approval, or whenever it is evident (despite stamp) that Drawings have not been checked, the District and/or Architect will not consider them and will return them to the Contractor for revision and resubmission. In that event, it will be deemed that Contractor has not complied with this provision and Contractor shall bear risk of all delays to same extent as if it had not submitted any Shop Drawings or details.
- J. Submission of Shop Drawings (in either original submission or when resubmitted with correction) constitutes evidence that Contractor has checked all information thereon and that it accepts and is willing to perform Work as shown.
- K. Contractor shall pay for cost of any changes in construction due to improper checking and coordination. Contractor shall be responsible for all additional costs, including coordination. Contractor shall be responsible for costs incurred by itself, the District, the Architect, the Project Inspector, the Construction Manager, any other Subcontractor or contractor, etc., due to improperly checked and/or coordination of submittals.
- L. Shop Drawings must clearly delineate the following information:
 - (1) Project name and address.
 - (2) Specification number and description.
 - (3) Architect's name and project number.
 - (4) Shop Drawing title, number, date, and scale.
 - (5) Names of Contractor, Subcontractor(s) and fabricator.

- (6) Working and erection dimensions.
 - (7) Arrangements and sectional views.
 - (8) Necessary details, including complete information for making connections with other Work.
 - (9) Kinds of materials and finishes.
 - (10) Descriptive names of materials and equipment, classified item numbers, and locations at which materials or equipment are to be installed in the Work. Contractor shall use same reference identification(s) as shown on Contract Drawings.
- M. Contractor shall prepare composite drawings and installation layouts when required to solve tight field conditions.
- (1) Shop Drawings shall consist of dimensioned plans and elevations and must give complete information, particularly as to size and location of sleeves, inserts, attachments, openings, conduits, ducts, boxes, structural interferences, etc.
 - (2) Contractor shall coordinate these composite Shop Drawings and installation layouts in the field between itself and its Subcontractor(s) for proper relationship to the Work, the work of other trades, and the field conditions. The Contractor shall check and approve all submittal(s) before submitting them for final review.

4.04 PRODUCT DATA OR NON REPRODUCIBLE SUBMITTALS:

- A. Contractor shall submit manufacturer's printed literature in original form. Any fading type of reproduction will not be accepted. Contract must submit a minimum of six (6) each, to the District. District shall return one (1) to the Contractor, who shall reproduce whatever additional copies it requires for distribution.
- B. Contractor shall submit six (6) copies of a complete list of all major items of mechanical, plumbing, and electrical equipment and materials in accordance with the approved Submittal Schedule, except as required earlier to comply with the approved Construction Schedule. Other items specified are to be submitted prior to commencing Work. Contractor shall submit items of like kind at one time in a neat and orderly manner. Partial lists will not be acceptable.
- C. Submittals shall include manufacturer's specifications, physical dimensions, and ratings of all equipment. Contractor shall furnish performance curves for all pumps and fans. Where printed literature describes items in addition to that item being submitted, submitted item shall be clearly marked on sheet and superfluous information shall be crossed out. If highlighting is used, Contractor shall mark all copies.

- D. Equipment submittals shall be complete and include space requirements, weight, electrical and mechanical requirements, performance data, and supplemental information that may be requested.
- E. Imported Materials Certification must be submitted at least ten (10) days before material is delivered.

4.05 SAMPLES:

- A. Contractor shall submit for approval Samples as required and within the time frame in the Contract Documents. Materials such as concrete, mortar, etc., which require on-site testing will be obtained from Project Site.
- B. Contractor shall submit four (4) samples except where greater or lesser number is specifically required by Contract Documents including, without limitation, the Specifications.
 - (1) Samples must be of sufficient size and quality to clearly illustrate functional characteristics, with integrally related parts and attachment devices.
 - (2) Samples must show full range of texture, color, and pattern.
- C. Contractor shall make all Submittals, unless it has authorized Subcontractor(s) to submit and Contractor has notified the District in writing to this effect.
- D. Samples to be shipped prepaid or hand-delivered to the District.
- E. Contractor shall mark samples to show name of Project, name of Contractor submitting, Contract number and segment of Work where representative Sample will be used, all applicable Specifications Sections and documents, Contract Drawing Number and detail, and ASTM or FS reference, if applicable.
- F. Contractor shall not deliver any material to Site prior to receipt of District's and/or Architect's completed written review and approval. Contractor shall furnish materials equal in every respect to approved Samples and execute Work in conformance therewith.
- G. District's and/or Architect's review, acceptance, and/or approval of Sample(s) will not preclude rejections of any material upon discovery of defects in same prior to final acceptance of completed Work.
- H. After a material has been approved, no change in brand or make will be permitted.
- I. Contractor shall prepare its Submittal Schedule and submit Samples of materials requiring laboratory tests to specified laboratory for testing not less than ninety (90) days before such materials are required to be used in Work.

- J. Samples which are rejected must be resubmitted promptly after notification of rejection and be marked "Resubmitted Sample" in addition to other information required.
- K. Field Samples and Mock-Ups are to be removed by Contractor at District's direction:
 - (1) Size: As Specified.
 - (2) Furnish catalog numbers and similar data, as requested.

4.06 REVIEW AND RESUBMISSION REQUIREMENTS:

- A. The District will arrange for review of Sample(s), Shop Drawing(s), Product Data, and other submittal(s) by appropriate reviewer and return to Contractor as provided below within twenty-one (21) days after receipt or within twenty-one (21) days after receipt of all related information necessary for such review, whichever is later.
- B. One (1) copy of product or materials data will be returned to Contractor with the review status.
- C. Samples to be incorporated into the Work will be returned to Contractor, together with a written notice designating the Sample with the appropriate review status and indicating errors discovered on review, if any. Other Samples will not be returned, but the same notice will be given with respect thereto, and that notice shall be considered a return of the Sample.
- D. Contractor shall revise and resubmit any Sample(s), Shop Drawing(s), Product Data, and other submittal(s) as required by the reviewer. Such resubmittals will be reviewed and returned in the same manner as original Sample(s), Shop Drawing(s), Product Data, and other submittal(s), within fourteen (14) days after receipt thereof or within fourteen (14) days after receipt of all related information necessary for such review. Such resubmittal shall not delay the Work.
- E. Contractor may proceed with any of the Work covered by Sample(s), Shop Drawing(s), Product Data, and other submittal(s) upon its return if designated as no exception taken, or revise as noted, provided the Contractor proceeds in accordance with the District and/or the Architect's notes and comments.
- F. Contractor shall not begin any of the work covered by a Sample(s), Shop Drawing(s), Product Data, and other submittal(s), designated as revise and resubmit or rejected, until a revision or correction thereof has been reviewed and returned to Contractor.
- G. Sample(s), Shop Drawing(s), Product Data, and other submittal(s) designated as revise and resubmit or rejected and requiring resubmittal, shall be revised or corrected and resubmitted to the District no later than fourteen (14) days or a shorter period as required to comply with the approved Construction Schedule, after its return to Contractor.

- H. Neither the review nor the lack of review of any Sample(s), Shop Drawing(s), Product Data, and other submittal(s) shall waive any of the requirements of the Contract Documents, or relieve Contractor of any obligation thereunder.
- I. District's and/or Architect's review of Shop Drawings does not relieve the Contractor of responsibility for any errors that may exist. Contractor is responsible for the dimensions and design of adequate connections and details and for satisfactory construction of all the Work.

PART 5 – PRODUCTS Not Used.

PART 6 - EXECUTION Not Used.

END OF DOCUMENT

SITE STANDARDS

PART 1 – GENERAL

1.01 RELATED DOCUMENTS AND PROVISIONS:

All Contract Documents should be reviewed for applicable provisions related to the provisions in this document, including without limitation:

- A. General Conditions, including without limitation, Site Access, Conditions, and Regulations;
- B. Special Conditions;
- C. Drug-Free Workplace Certification;
- D. Tobacco-Free Environment Certification;
- E. Criminal Background Investigation/Fingerprinting Certification;
- F. Temporary Facilities and Controls.

1.02 REQUIREMENTS OF THE DISTRICT:

- A. Drug-Free Schools and Safety Requirements:
 - (1) All school sites and other District Facilities have been declared "Drug-Free Zones." No drugs, alcohol and/or smoking are allowed at any time in any buildings and/or grounds on District property. No students, staff, visitors, or contractors are to use drugs on these sites.
 - (2) Smoking and the use of tobacco products by all persons is prohibited on or in District property. District property includes school buildings, school grounds, school-owned vehicles and vehicles owned by others while on District property. Contractor shall post: "Non-Smoking Area" in a highly visible location in each work area, staging area, and parking area. Contractor may designate a smoking area outside of District property within the public right-of-way, provided that this area remains quiet and unobtrusive to adjacent neighbors. This smoking area is to be kept clean at all times.
 - (3) Contractor shall ensure that no alcohol, firearms, weapons, or controlled substances enter or are used at the Site. Contractor shall immediately remove from the Site and terminate the employment of any employee(s) found in violation of this provision.
- B. Language: Profanity or other unacceptable and/or loud language will not be tolerated, "Cat calls" or other derogatory language toward students, staff, volunteers, parents or public will not be allowed.

- C. Disturbing the Peace (Noise and Lighting):
- (1) Contractor shall observe the noise ordinance of the Site at all times including, without limitation, all applicable local, city, and/or state laws, ordinances, and/or regulations regarding noise and allowable noise levels.
 - (2) The use of radios, etc., shall be controlled to keep all sound at a level that cannot be heard beyond the immediate area of use. District reserves the right to prohibit the use of radios at the Site, except for mobile phones or other handheld communication radios.
 - (3) If portable lights are used after dark, all light must be located so as not to direct light into neighboring property.
- D. Traffic:
- (1) Driving on the Premises shall be limited to periods when students and public are not present. If driving or deliveries must be made during the school hours, two (2) or more ground guides shall lead the vehicle across the area of travel. In no case shall driving take place across playgrounds or other pedestrian paths during recess, lunch, and/or class period changes. The speed limit on-the Premises shall be five (5) miles per hour (maximum) or less if conditions require.
 - (2) All paths of travel for deliveries, including without limitation, material, equipment, and supply deliveries, shall be reviewed and approved by District in advance. Any damage will be repaired to the pre-damaged condition by the Contractor.
 - (3) District shall designate a construction entry to the Site. If Contractor requests, District determines it is required, and to the extent possible, District shall designate a staging area so as not to interfere with the normal functioning of school facilities. Location of gates and fencing shall be approved in advance with District and at Contractor's expense.
 - (4) Parking areas shall be reviewed and approved by District in advance. No parking is to occur under the drip line of trees or in softscape areas that could otherwise be damaged.
- E. All of the above shall be observed and complied with by the Contractor and all workers on the Site. Failure to follow these directives could result in individual(s) being suspended or removed from the work force at the discretion of the District. The same rules and regulations shall apply equally to delivery personnel, inspectors, consultants, and other visitors to the Site.

PART 2 - PRODUCTS Not Used.

PART 3 - EXECUTION Not Used.

END OF DOCUMENT

REGULATORY REQUIREMENTS

PART 1 - GENERAL

1.01 RELATED DOCUMENTS AND PROVISIONS:

All Contract Documents should be reviewed for applicable provisions related to the provisions in this document, including without limitation:

- A. General Conditions, including, without limitation, Obtaining of Permits, Licenses and Registrations and Work to Comply with All Applicable Laws and Regulations;
- B. Special Conditions; and
- C. Quality Control.

1.02 DESCRIPTION:

This section covers the general requirements for regulatory requirements pertaining to the Work and is supplementary to all other regulatory requirements mentioned or referenced elsewhere in the Contract Documents.

1.03 REQUIREMENTS OF REGULATORY AGENCIES:

- A. All statutes, ordinances, laws, rules, codes, regulations, standards, and the lawful orders of all public authorities having jurisdiction over the Work, are hereby incorporated into these Contract Documents as if repeated in full herein and are intended to be included in any reference to Code or Building Code, unless otherwise specified, including, without limitation, the references in the list below. Contractor shall make available at the Site copies of all the listed documents applicable to the Work as the District and/or Architect may request, including, without limitation, applicable portions of the California Code of Regulations ("CCR").
 - (1) California Building Standards Administrative Code, Part 1, Title 24, CCR.
 - (2) California Building Code (CBC), Part 2, Title 24, CCR; (International Building Code volumes 1-2 and California Amendments).
 - (3) California Electrical Code (CEC), Part 3, Title 24, CCR; (National Electrical Code and California Amendments).
 - (4) California Mechanical Code (CMC), Part 4, Title 24, CCR; (Uniform Mechanical Code and California Amendments).
 - (5) California Plumbing Code (CPC), Part 5, Title 24, CCR; (Uniform Plumbing Code and California Amendments).

- (6) California Fire Code (CFC), Part 9, Title 24, CCR; (International Fire Code and California Amendments).
- (7) California Green Building Standards Code (CALGreen), Part 11, Title 24, CCR.
- (8) California Referenced Standards Code, Part 12, Title 24, CCR.
- (9) State Fire Marshal Regulations, Public Safety, Title 19, CCR.
- (10) Partial List of Applicable National Fire Protection Association (NFPA) Standards:
 - (a) NFPA 13 - Automatic Sprinkler System.
 - (b) NFPA 14 - Standpipes Systems.
 - (c) NFPA 17A - Wet Chemical System
 - (d) NFPA 24 - Private Fire Mains.
 - (e) (California Amended) NFPA 72 - National Fire Alarm Codes.
 - (f) NFPA 253 - Critical Radiant Flux of Floor Covering System.
 - (g) NFPA 2001 - Clean Agent Fire Extinguishing Systems.
- (11) California Division of the State Architect interpretation of Regulations ("DSA IR"), including, without limitation:
 - (a) DSA IR A-6 — Construction Change Document Submittal and Approval Processes.
 - (b) DSA IR A-7 — Project Inspector Certification and Approval.
 - (c) DSA IR A-8 — Project Inspector and Assistant Inspector Duties and Performance.
 - (d) DSA IR A-12 — Assistant Inspector Approval.
- (12) DSA Procedures ("DSA PR")
 - (a) DSA PR 13-01 – Construction Oversight Process
 - (b) DSA PR 13-02 – Project Certification Process

B. This Project shall be governed by applicable regulations, including, without limitation, the State of California's Administrative Regulations for the Division of the State Architect-Structural Safety (DSA/SS), Chapter 4, Part 1, Title 24, CCR, and the most current version on the date the bids are opened and as it pertains to school construction including, without limitation:

- (1) Test and testing laboratory per Section 4-335. District shall pay for the testing laboratory.
- (2) Special inspections per Section 4-333(c).
- (3) Deferred Approvals per section 4-317(g).
- (4) Verified reports per Sections 4-336 & 4-343(c).
- (5) Duties of the Architect & Engineers shall be per Sections 4-333(a) and 4-341.
- (6) Duties of the Contractor shall be per Section 4-343.
- (7) Duties of Project Inspector shall be per Section 4-334.
- (8) Addenda and Construction Change Documents per Section 4-338.

Contractor shall keep and make available all applicable parts of the most current version of Title 24 referred to in the plans and specifications at the Site during construction.

- C. Items of deferred approval shall be clearly marked on the first sheet of the Architect's and/or Engineer's approved Drawings. All items later submitted for approval shall be per Title 24 requirements to the DSA.
- (1) Contractor shall submit the following to Architect for review and endorsement:
 - (a) Product information on proposed material/system supplier.
 - (b) Drawings, specifications, and calculations prepared, signed, and stamped by an architect or engineer licensed in the State of California for that portion of the Work.
 - (c) All other requirements as may be required by DSA.
 - (2) Cost of preparing and submitting documentation per DSA Deferred Approval requirements including required modifications to Drawings and Specifications, whether or not indicated in the Contract Documents, shall be borne by Contractor.
 - (3) Contractor shall not begin fabrication and installation of deferred approval items without first obtaining DSA approval of Drawings and Specifications.
 - (4) Schedule of Work Subject to DSA Deferred Approval: Window wall systems exceeding 10 feet in span.

PART 2 – PRODUCTS Not Used.

PART 3 – EXECUTION Not Used.

END OF DOCUMENT

ABBREVIATIONS AND ACRONYMS

PART 1 – GENERAL

1.01 RELATED DOCUMENTS AND PROVISIONS:

All Contract Documents should be reviewed for applicable provisions related to the provisions in this document, including without limitation:

- A. General Conditions including without limitation, Definitions;
- B. Special Conditions.

1.02 DOCUMENT INCLUDES:

- A. Abbreviations used throughout the Contract Documents.
- B. Reference to a technical society, organization, or body is by abbreviation, as follows:

1.	AA	The Aluminum Association
2.	AASHTO	American Association of State Highway and Transportation Officials
3.	ABPA	Acoustical and Board Products Association
4.	ACI	American Concrete Institute
5.	AGA	American Gas Association
6.	AGC	Associated General Contractors of America
7.	AHC	Architectural Hardware Consultant
8.	AHRI	Air Conditioning, Heating, Refrigeration Institute
9.	AI	Asphalt Institute
10.	AIA	American Institute of Architects
11.	AISC	American Institute of Steel Construction
12.	AISI	American Iron and Steel Institute
13.	AMCA	Air Movement and Control Association
14.	ANSI	American National Standards Institute
15.	APA	APA – The Engineered Wood Association
16.	ASCE	American Society of Civil Engineers
17.	ASHRAE	American Society of Heating, Refrigeration and Air Conditioning Engineers
18.	ASME	American Society of Mechanical Engineers
19.	ASTM	American Society of Testing and Materials International
20.	AWPA	American Wood Protection Association
21.	AWPI	American Wood Preservers Institute
22.	AWS	American Welding Society
23.	AWSC	American Welding Society Code
24.	AWI	Architectural Woodwork Institute
25.	AWWA	American Water Works Association

26.	BIA	The Brick Industry Association
27.	CCR	California Code of Regulations
28.	CLFMI	Chain Link Fence Manufacturers Institute
29.	CRA	California Redwood Association
30.	CRSI	Concrete Reinforcing Steel Institute
31.	CS	Commercial Standards
32.	CSI	Construction Specifications Institute
33.	CTI	Cooling Technology Institute
34.	FGIA	Fenestration and Glazing Industry Alliance
35.	FGMA	Flat Glass Manufacturers' Association
36.	FIA	Factory Insurance Association
37.	FM	Factory Mutual Global
38.	FS/FED SPEC	Federal Specification
39.	FTI	Facing Title Institute
40.	GA	Gypsum Association
41.	IAPMO	International Association of Plumbing and Mechanical Officials
42.	ICC	International Code Council
43.	IEEE	Institute of Electrical and Electronics Engineers
44.	IES	Illuminating Engineering Society
45.	MCAC	Mason Contractors Association of California
46.	MIMA	Mineral Wool Insulation Manufacturers Association
47.	MLMA	Metal Lath Manufacturers Association
48.	MS/MIL SPEC	Military Specifications
49.	NAAMM	National Association of Architectural Metal Manufacturers
50.	NBHA	National Builders Hardware Association
51.	NCMA	National Concrete Masonry Association
52.	NCSEA	National Council of Structural Engineers Associations
53.	NEC	National Electrical Code
54.	NEMA	National Electrical Manufacturers Association
55.	NIST	National Institute of Standards and Technology
56.	NSI	Natural Stone Institute
57.	NTMA	National Terrazzo and Mosaic Association, Inc.
58.	ORS	Office of Regulatory Services (California)
59.	OSHA	Occupational Safety and Health Act
60.	PCI	Precast/Prestressed Concrete Institute
61.	PCA	Portland Cement Association
62.	PCA	Painting Contractors Association
63.	PDI	Plumbing Drainage Institute
64.	PEI	Porcelain Enamel Institute, Inc.
65.	PG&E	Pacific Gas & Electric Company
66.	PS	Product Standards
67.	SDI	Steel Door Institute; Steel Deck Institute
68.	SJI	Steel Joist Institute
69.	SSPC	Society for Protective Coatings
70.	TCNA	Tile Council of North America, Inc.
71.	TPI	Truss Plate Institute

72.	UBC	Uniform Building Code
73.	UL	Underwriters Laboratories Code
74.	UMC	Uniform Mechanical Code
75.	USDA	United States Department of Agriculture
76.	VI	Vermiculite Institute
77.	WCLIB	West Coast Lumber Inspection Bureau
78.	WDMA	Window and Door Manufacturers Association
79.	WEUSER	Western Electric Utilities Service Engineering Requirements
80.	WIC	Woodwork Institute of California

PART 2 - PRODUCTS Not Used.

PART 3 - EXECUTION Not Used.

END OF DOCUMENT

DEFINITIONS

PART 1 - GENERAL

1.01 RELATED DOCUMENTS AND PROVISIONS

All Contract Documents should be reviewed for applicable provisions related to the provisions in this document, including without limitation:

- A. General Conditions including without limitation, Definitions;
- B. Special Conditions.

1.02 QUALITY ASSURANCE

- A. For products or workmanship specified by association, trade, or Federal Standards, Contractor shall comply with requirements of the standard, except when more rigid requirements are specified in the Contract Documents, or are required by applicable codes.
- B. Contractor shall conform to current reference standard publication date in effect on the date of bid opening.
- C. Contractor shall obtain copies of standards unless specifically required not to by the Contract Documents.
- D. Contractor shall maintain a copy of all standards at jobsite during submittals, planning, and progress of the specific Work, until final completion, unless specifically required not to by the Contract Documents.
- E. Should specified reference standards conflict with Contract Documents, Contractor shall request clarification from the District and/or the Architect before proceeding.
- F. The contractual relationship of the parties to the Contract shall not be altered from the contractual relationship as indicated in the Contract Documents by mention or inference otherwise in any referenced document.
- G. Governing Codes shall be as shown in the Contract Documents including, without limitation, the Specifications.

END OF DOCUMENT

REFERENCES**PART 1- GENERAL****1.01 SCHEDULE OF REFERENCES:**

The following information is intended only for the general assistance of the Contractor, and the District does not represent that all of the information is current. It is the Contractor's responsibility to verify the correct information for each of the entities listed.

AA	The Aluminum Association 1400 Crystal Drive, Suite 430 Arlington, VA 22202 www.aluminum.org	703/358-2960
AABC	Associated Air Balance Council 2401 Pennsylvania Avenue NW, Suite 330 Washington, DC 20037 www.aabc.com	202/737-0202
AASHTO	American Association of State Highway and Transportation Officials 555 12th St. NW - Suite 1000 Washington, DC 20004 www.transportation.org	202/624-5800
AATCC	American Association of Textile Chemists and Colorists P.O. Box 12215 Research Triangle Park, NC 27709-2215 www.aatcc.org	919/549-8141
ACA	American Coatings Association 901 New York Ave., NW, Suite 300 West Washington, DC 20001 www.paint.org	202/462-6272
ACI	American Concrete Institute 38800 Country Club Dr. Farmington Hills, MI 48331-3439 www.concrete.org	248/848-3800
ACPA	American Concrete Pipe Association 5605 N. MacArthur Blvd., Suite 340 Irving, TX 75038 www.concrete-pipe.org	972/506-7216
ADC	Air Duct Council 1901 N. Roselle Road, Suite 800 Schaumburg, IL 60195 www.flexibleduct.org	847/706-6750

AF&PA	American Forest and Paper Association 1101 K Street, NW, Suite 700 Washington, DC 20005 www.afandpa.org	202/463-2700
AGA	American Gas Association 400 North Capitol Street, NW, Suite 450 Washington, DC 20001 www.aga.org	202/824-7000
AGC	Associate General Contractors of America 2300 Wilson Blvd., Suite 300 Arlington, VA 22201 www.agc.org	703/548-3118
AHA	American Hardboard Association 1210 West Northwest Highway Palatine, IL 60067 http://domensino.com/AHA/default.htm	847/934-8800
AI	Asphalt Institute 2696 Research Park Drive Lexington, KY 40511-8480 www.asphaltinstitute.org	859/288-4960
AIA	The American Institute of Architects 1735 New York Ave., NW Washington, DC 20006-5292 www.aia.org	202/626-7300
AISC	American Institute of Steel Construction 130 East Randolph Street, Suite 2000 Chicago, IL 60601 www.aisc.org	312.670.2400
AISI	American Iron and Steel Institute 25 Massachusetts Ave., NW, Suite 800 Washington, DC 20001 www.steel.org	202/452-7100
AITC	American Institute of Timber Construction 1010 South 336th Street, #210 Federal Way, WA 98003-7394 https://www.plib.org/aitc/	253/835-3344
ALI	Associated Laboratories, Inc. P.O. Box 152837 Dallas, TX 75315 www.assoc-labs.com	214/565-0593

ALSC	American Lumber Standards Committee, Inc. 7470 New Technology Way, Suite F Frederick, MD 21703 www.alsc.org	301/972-1700
AMCA	Air Movement and Control Association International, Inc. 30 W. University Drive Arlington Heights, IL 60004 www.amca.org	847/394-0150
AMPP (formerly SSPC)	Association for Materials Protection and Performance (merger of Society for Protective Coatings and National Association of Corrosion Engineers International) (formerly Steel Structures Painting Council) 800 Trumbull Drive Pittsburgh, PA 15205 www.sspc.org	412/281-2331 877/281-7772
ANLA	AmericanHort (merger of American Nursery & Landscape Association and OFA – The Association of Horticultural Professionals) 2130 Stella Court Columbus, OH 43215 www.americanhort.org	614/487-1117
ANSI	American National Standards Institute 1899 L Street, NW, 11th Floor Washington, DC 20036 www.ansi.org	202/293-8020
APA	APA-The Engineered Wood Association 7011 S. 19th Street Tacoma, WA 98466-5333 www.apawood.org	253/565-6600
APA	Architectural Precast Association 325 John Knox Rd, Suite L-103 Tallahassee, FL 32303 www.archprecast.org	850/205-5637
APCIA	American Property Casualty Insurance Association (merger of American Insurance Association (formerly the National Board of Fire Underwriters) with the Property Casualty Insurers Association of America) 555 12th St, NW, Suite 550 Washington DC 20004 www.apci.org	202/828-7100

AHRI	Air Conditioning and Refrigeration Institute (now Air-Conditioning, Heating, & Refrigeration Institute) 2311 Wilson Blvd, Suite 400 Arlington, VA 22201 www.ahrinet.org	703/524-8800
ARMA	Asphalt Roofing Manufacturers Association 2331 Rock Spring Road Forest Hill, MD 21050 www.asphaltroofing.org	443/640-1075
ASA	The Acoustical Society of America Suite 300 1305 Walt Whitman Road Melville, NY 11747-4300 https://acousticalsociety.org/	516/576-2360
ASCE	American Society of Civil Engineers 1801 Alexander Bell Drive Reston, VA 20191 www.asce.org	800/548-2723 703/295-6300
ASHRAE	American Society of Heating, Refrigerating and Air Conditioning Engineers 180 Technology Parkway Peachtree Corners, GA 30092 www.ashrae.org	800/527-4723 404/636-8400
ASLA	American Society of Landscape Architects 636 Eye Street, NW Washington, DC 20001-3736 www.asla.org	202/898-2444
ASME	American Society of Mechanical Engineers Two Park Avenue New York, NY 10016-5990 www.asme.org	800/834-2763
ASPE	American Society of Plumbing Engineers 6400 Shafer Court, Suite 350 Rosemont, IL 60018 http://aspe.org	847/296-0002
ASQ	American Society for Quality P.O. Box 3005 Milwaukee, WI 53201-3005 or 600 North Plankinton Avenue Milwaukee, WI 53203 http://asq.org	800/248-1946 414/272-8575

ASSE	American Society of Sanitary Engineering 18927 Hickory Creek Dr., Suite 220 Mokena, IL 60448 www.asse-plumbing.org	708/995-3019
ASTM	ASTM International 100 Barr Harbor Drive PO Box C700 West Conshohocken, PA, 19428-2959 www.astm.org	610/832-9500
AWCI	Association of the Wall and Ceiling Industry 513 West Broad Street, Suite 210 Falls Church, VA 22046 www.awci.org	703/538-1600
AWPA	American Wood Protection Association (formerly American Wood Preservers Institute) P.O. Box 361784 Birmingham, AL 35236-1784 www.awpa.com	205/733-4077
AWS	American Welding Society 8669 NW 36 Street, Suite 130 Miami, FL 33166 www.aws.org	800/443-9353 305/443-9353
AWI	Architectural Woodwork Institute 46179 Westlake Drive, Suite 120 Potomac Falls, VA 20165-5874 www.awinet.org	571/323-3636
AWWA	American Water Works Association 6666 West Quincy Avenue Denver, CO 80235 www.awwa.org	800/926-7337 303/794-7711
BHMA	Builders Hardware Manufacturers Association 355 Lexington Avenue, 15th Floor New York, NY 10017 www.buildershardware.com	212/297-2122
BIA	The Brick Industry Association 12007 Sunrise Valley Drive, Suite 430 Reston, VA 20191 www.gobrick.com	703/620-0010

CGA	Compressed Gas Association 8484 Westpark Drive, Suite 220 McLean, VA 22102 www.cganet.com	703/788-2700
CISCA	Ceilings & Interior Systems Construction Association 1010 Jorie Blvd, Suite 30 Oak Brook, IL 60523 www.cisca.org	630/584-1919
CISPI	Cast Iron Soil Pipe Institute 2401 Fieldcrest Dr. Mundelein, IL 60060 www.cispi.org	224/864-2910
CLFMI	Chain Link Fence Manufacturers Institute 10015 Old Columbia Road, Suite B-215 Columbia, MD 21046 chainlinkinfo.org	301/596-2583
CPA	Composite Panel Association 19465 Deerfield Avenue, Suite 306 Leesburg, VA 20176 www.compositepanel.org	703/724-1128
CPSC	Consumer Product Safety Commission 4330 East-West Highway Bethesda, MD 20814 www.cpsc.gov	800/638-2772
CRA	California Redwood Association 818 Grayson Road, Suite 201 Pleasant Hill, CA 94523 www.calredwood.org	925/935-1499
CRI	Carpet and Rug Institute 100 S. Hamilton Street Dalton, GA 30722-2048 www.carpet-rug.org	706/278-3176
CRSI	Concrete Reinforcing Steel Institute 933 N. Plum Grove Road Schaumburg, IL 60173-4758 www.crsi.org	847/517-1200
CSI	The Construction Specifications Institute 123 North Pitt St, Suite 450 Alexandria, VA 22314 www.csinet.org	800/689-2900

CTIOA	Ceramic Tile Institute of America 12061 Jefferson Blvd. Culver City, CA 90230-6219 www.ctioa.org	310/574-7800
DHA	Decorative Hardwoods Association (formerly Hardwood Plywood & Veneer Association) 42777 Trade West Dr. Sterling, VA 20166 https://www.decorativehardwoods.org/	703/435-2900
DHI	Door and Hardware Institute (formerly National Builders Hardware Association) 2001 K Street NW, 3rd Floor North Washington, DC 20006 www.dhi.org	202/367-1134
DIPRA	Ductile Iron Pipe Research Association P.O. Box 190306 Birmingham, AL 35219 www.dipra.org	205/402-8700
DOC	U.S. Department of Commerce 1401 Constitution Ave., NW Washington, DC 20230 www.commerce.gov	202/482-2000
DOT	U.S. Department of Transportation 1200 New Jersey Avenue, SE Washington, DC 20590 www.dot.gov	855/368-4200
EJMA	Expansion Joint Manufacturers Association, Inc. 25 North Broadway Tarrytown, NY 10591 www.ejma.org	914/332-0040
EPA	Environmental Protection Agency Ariel Rios Building 1200 Pennsylvania Avenue, N.W. Washington, DC 20460 www.epa.gov	202/272-0167
FCICA	Floor Covering Installation Contractors Association 800 Roosevelt Rd., Bldg. C, Suite 312 Glen Ellyn, IL 60137 www.fcica.com	630/672-3702

FGIA	Fenestration and Glazing Industry Alliance 1900 E Golf Rd, Suite 1250 Schaumburg, IL 60173 https://fgiaonline.org/	847/303-5664
FM Global	Factory Mutual Insurance Company Amy Daley Global Practice Leader – Education, Public Entities, Health Care FM Global 270 Central Avenue Johnston, RI 02919-4949 www.fmglobal.com	401/275-3000 401/275-3029
FS	General Services Administration (GSA) Index of Federal Specifications, Standards and Commercial Item Descriptions 470 East L’Enfant Plaza, SW, Suite 8100 Washington, DC 20407 www.gsa.gov	202/619-8925
GA	The Gypsum Association 962 Wayne Ave., Suite 620 Silver Spring, MD 20910 www.gypsum.org	301/277-8686
HMA	Hardwood Manufacturers Association One Williamsburg Place, Suite 108 Warrendale, PA 15086 http://hmamembers.org	412/244-0440
IAPMO	International Association of Plumbing and Mechanical Officials (formerly the Western Plumbing Officials Association) 4755 E. Philadelphia St. Ontario, CA 91761 www.iapmo.org	909/472-4100
ICC	International Code Council 500 New Jersey Avenue, NW, 6th Floor Washington, DC 20001 www.iccsafe.org	888/422-7233
IEEE	Institute of Electrical and Electronics Engineers 3 Park Avenue, 17th Floor New York, NY 10016-5997 www.ieee.org	212/419-7900

IES	<p>Illuminating Engineering Society 120 Wall Street, Floor 17 New York, NY 10005-4001 www.ies.org</p>	212/248-5000
ITRK	<p>Intertek Testing Services 3933 US Route 11 Cortland, NY 13045 www.intertek.com</p>	607/753-6711
MCAA	<p>Mechanical Contractors Association of America 1385 Piccard Drive Rockville, MD 20850 www.mcaa.org</p>	301/869-5800
MMPA (formerly WMMPA)	<p>Moulding & Millwork Producers Association (formerly Wood Moulding & Millwork Producers Association) 507 First Street Woodland, CA 95695 www.wmmpa.com</p>	530/661-9591 800/550-7889
MSS	<p>Manufacturers Standardization Society (MSS) of the Valve and Fittings Industry, Inc. 127 Park Street, NE Vienna, VA 22180-4602 http://mss-hq.org</p>	703/281-6613
NAAMM	<p>National Association of Architectural Metal Manufacturers 800 Roosevelt Rd. Bldg. C, Suite 312 Glen Ellyn, IL 60137 www.naamm.org</p>	630/942-6591
NAIMA	<p>North American Insulation Manufacturers Association P.O. Box 1906 Alexandria, VA 22313 https://insulationinstitute.org/</p>	703/684-0084
NALP	<p>National Association of Landscape Professionals (formerly Professional Landcare Network) 12500 Fair Lakes Circle, Suite 200 Fairfax, VA 22033 https://www.landscapeprofessionals.org/</p>	703/736-9666
NAPA	<p>National Asphalt Pavement Association 6406 Ivy Lane, Suite 350 Greenbelt, MD 20770-1441 www.asphaltpavement.org</p>	888/468-6499 301/731-4748

NCSPA	National Corrugated Steel Pipe Association 14070 Proton Road, Suite 100 Dallas, TX 75244 www.ncspa.org	972/850-1907
NCMA	National Concrete Masonry Association 13750 Sunrise Valley Drive Herndon, VA 20171-4662 www.ncma.org	703/713-1900
NEBB	National Environmental Balancing Bureau 8575 Grovemont Circle Gaithersburg, MD 20877 www.nebb.org	301/977-3698
NECA	National Electrical Contractors Association 1201 Pennsylvania Ave. NW Washington, D.C., 20004 www.necanet.org	202/991-6300
NEMA	National Electrical Manufacturers Association 1300 North 17th Street N, Suite 900 Rosslyn, VA 22209 www.nema.org	703/841-3200
NEII	National Elevator Industry, Inc. 5537 SW Urish Road Topeka, KS 66610 https://nationalelevatorindustry.org/	703/589-9985
NFPA	National Fire Protection Association 1 Batterymarch Park Quincy, MA 02169-7471 www.nfpa.org	800/344-3555 855/274-8525
NGA (formerly GANA)	National Glass Association (merged with Glass Association of North America) 1945 Old Gallows Road Suite 750 Vienna, VA 22182 www.glass.org	866/342-5642 Ext 127
NHLA	National Hardwood Lumber Association PO Box 34518 Memphis, TN 38184 www.nhla.com	901/377-1818
NIA	National Insulation Association 516 Herndon Pkwy., Ste. D Herndon, VA 20170 www.insulation.org	703/464-6422

NRCA	National Roofing Contractors Association 10255 W. Higgins Road, Suite 600 Rosemont, IL 60018-5607 www.nrca.net	847/299-9070
NSF	NSF International 789 N. Dixboro Road Ann Arbor, MI 48113-0140 www.nsf.org	800/673-6275 734/769-8010
NSI	Natural Stone Institute (formerly Marble Institute of America) 380 E. Lorain St. Oberlin, OH 44074 https://www.naturalstoneinstitute.org/	440/250-9222
NTMA	National Terrazzo and Mosaic Association 209 N. Crockett Street, Suite 2 PO Box 2605 Fredericksburg, TX 78624 www.ntma.com	800/323-9736
OSHA	Occupational Safety and Health Act U.S. Department of Labor Occupational Safety & Health Administration 200 Constitution Ave., NW Washington, DC 20210 www.osha.gov	800/321-OSHA (6742)
PCA	Portland Cement Association 5420 Old Orchard Road Skokie, IL 60077 or 200 Massachusetts Ave NW, Suite 200 Washington, DC 20001 www.cement.org	847/966-6200 202/408-9494
PCA	Painting Contractors Association (formerly Painting and Decorating Contractors of America) 2316 Millpark Drive Maryland Heights, MO 63043 https://www.pcapainted.org/	800/322-7322
PCI	Precast/Prestressed Concrete Institute 8770 W. Bryn Mawr Ave., Suite 1150 Chicago, IL 60631 www.pci.org	312/786-0300

PDI	Plumbing & Drainage Institute 800 Turnpike Street, Suite 300 North Andover, MA 01845 http://pdionline.org	978/557-0720 800/589-8956
PEI	Porcelain Enamel Institute, Inc. P.O. Box 920220 Norcross, GA 30010 www.porcelainenamel.com	770/676-9366
PG&E	Pacific Gas & Electric Company P.O. Box 997300 Sacramento, CA 95899-7300 www.pge.com	800/743-5000
PLIB	Pacific Lumber Inspection Bureau (formerly West Coast Lumber Inspection Bureau) 1010 South 336th Street, Suite 210 Federal Way, WA 98003-7394 https://www.plib.org/	253/835-3344
RFCI	Resilient Floor Covering Institute 115 Broad Street, Suite 201 La Grange, GA 30240 www.rfci.com	706/882-3833
SDI	Steel Deck Institute P.O. Box 426 Glenshaw, PA 15116 www.sdi.org	412/487-3325
SDI	Steel Door Institute 30200 Detroit Road Westlake, OH 44145 www.steeldoor.org	440/899-0010
SJI	Steel Joist Institute 140 West Evans Street, Suite 203 Florence, SC 29501 http://steeljoist.org	843/407-4091
SMA	Stucco Manufacturers Association 5753 E Santa Ana Cyn Rd, #G-156 Anaheim, CA 92807 www.stuccomfgassoc.com	714/473-9579
SMACNA	Sheet Metal and Air Conditioning Contractors' National Association 4201 Lafayette Center Drive Chantilly, VA 20151-1219 www.smacna.org	703/803-2980

SPI	SPI: The Plastics Industry Trade Association, Inc. 1425 K St. NW, Suite 500 Washington, DC 20005 www.plasticsindustry.org	202/974-5200
TCA	The Tile Council of North America 100 Clemson Research Blvd. Anderson, SC 29625 www.tcnatile.com	864/646-8453
TPI	Truss Plate Institute 2670 Crain Highway, Suite 203 Waldorf, MD 20601 www.tpinst.org	240/587-5582
TPI	Turfgrass Producers International 444 E. Roosevelt Road #346 Lombard, IL 60148 www.turfgrassod.org	800/405-8873 847/649-5555
TCIA	Tree Care Industry Association (formerly the National Arborist Association) 670 N Commercial Street, Suite 201 Manchester, NH 03101 www.tcia.org	603/314-5380 800/733-2622
TVI	The Vermiculite Institute c/o The Schundler Company 10 Central Street Nahant, MA 01908 www.vermiculiteinstitute.org	732/287-2244
UL	Underwriters Laboratories Inc. 333 Pfingsten Road Northbrook, IL 60062-2096 www.ul.com	847/272-8800 877/854-3577
UNI	Uni-Bell PVC Pipe Association 201 E. John Carpenter Freeway, Suite 750 Irving, TX 75062 www.uni-bell.org	972/243-3902
USDA	U.S. Department of Agriculture 1400 Independence Ave., S.W. Washington, DC 20250 www.usda.gov	202/720-2791

WA	Wallcoverings Association 35 E Wacker Dr., Suite 850 Chicago, IL 60601 www.wallcoverings.org	312/224-2574
WCMA	Window Covering Manufacturers Association 355 Lexington Avenue 15th Floor New York, NY 10017 www.wcmanet.org	212/297-2122
WDMA	Window & Door Manufacturers Association 2001 K Street NW, 3rd Floor North Washington, D.C. 20006 www.wdma.com	202/367-1157
WI	Woodwork Institute 1455 Response Road, Suite 110 Sacramento, CA 95815 www.wicnet.org	916/372-9943
WRI	Wire Reinforcement Institute 942 Main Street, Suite 300 Hartford, CT 06103 www.wirereinforcementinstitute.org	860/240-9545
WWCA	Western Wall & Ceiling Contractors Association 1910 N. Lime St. Orange, CA 92865 www.wwcca.org	714/221-5520
WWPA	Western Wood Products Association (formerly Redwood Inspection Service) 1500 SW First Ave., Suite 870 Portland, OR 97201 www.wwpa.org	503/224-3930

- **PART 2 PRODUCTS Not Used.**

-

PART 3 EXECUTION Not Used.

END OF DOCUMENT

MATERIALS AND EQUIPMENT

PART 2 - GENERAL

2.01 RELATED DOCUMENTS AND PROVISIONS

All Contract Documents should be reviewed for applicable provisions related to the provisions in this document, including without limitation:

- A. General Conditions, including, without limitation, Purchase of Materials and Equipment;
- B. Special Conditions;
- C. Imported Materials Certification.

2.02 MATERIAL AND EQUIPMENT

- A. Only items approved by the District and/or Design Professional shall be used.
- B. Contractor shall submit lists of products and other product information in accordance with the Contract Documents, including, without limitation, the provisions regarding the submittals.

2.03 MATERIAL AND EQUIPMENT COLORS

- A. The District and/or Architect will provide a schedule of colors.
- B. No individual color selections will be made until after approval of all pertinent materials and equipment and after receipt of appropriate samples in accordance with the Contract Documents, including, without limitation, the provisions regarding the submittals.
- C. Contractor shall request priority in writing for any item requiring advance ordering to maintain the approved Construction Schedule.

2.04 DELIVERY, STORAGE, AND HANDLING

- A. Contractor shall deliver manufactured materials in original packages, containers, or bundles (with seals unbroken), bearing name or identification mark of manufacturer.
- B. Contractor shall deliver fabrications in as large assemblies as practicable; where specified as shop-primed or shop-finished, package or crate as required to preserve such priming or finish intact and free from abrasion.
- C. Contractor shall store materials in such a manner as necessary to properly protect them from damage. Materials or equipment damaged by handling, weather, dirt, or from any other cause will not be accepted.

- D. Materials are not acceptable that have been warehoused for long periods of time, stored or transported in improper environment, improperly packaged, inadequately labeled, poorly protected, excessively shipped, deviated from normal distribution pattern, or reassembled.
- E. Contractor shall store material so as to cause no obstructions of sidewalks, roadways, access to the Site or buildings, and underground services. Contractor shall protect material and equipment furnished under Contract.
- F. Contractor may store materials on Site with prior written approval by the District, all material shall remain under Contractor's control and Contractor shall remain liable for any damage to the materials. Should the Project Site not have storage area available, the Contractor shall provide for off-site storage at a bonded warehouse and with appropriate insurance coverage at no cost to District.
- G. When any room in Project is used as a shop or storeroom, the Contractor shall be responsible for any repairs, patching, or cleaning necessary due to that use. Location of storage space shall be subject to prior written approval by District.

PART 3 - PRODUCTS

3.01 MANUFACTURERS

- A. Manufacturers listed in various sections of Contract Documents are names of those manufacturers that are believed to be capable of supplying one or more of items specified therein.
- B. The listing of a manufacturer does not imply that every product of that manufacturer is acceptable as meeting the requirements of the Contract Documents.

3.02 FACILITIES AND EQUIPMENT

Contractor shall provide, install, maintain, and operate a complete and adequate facility for handling, the execution, disposal, and distribution of material and equipment as required for proper and timely performance of Work connected with Contract.

3.03 MATERIAL REFERENCE STANDARDS

Where material is specified solely by reference to "standard specifications" and if requested by District, Contractor shall submit for review data on actual material proposed to be incorporated into Work of Contract listing name and address of vendor, manufacturer, or producer, and trade or brand names of those materials, and data substantiating compliance with standard specifications.

PART 4 - EXECUTION

4.01 WORKMANSHIP

- A. Where not more specifically described in any other Contract Documents, workmanship shall conform to methods and operations of best standards and accepted practices of trade or trades involved and shall include items of fabrication, construction, or installation regularly furnished or required for completion (including finish and for successful operation, as intended).
- B. Work shall be executed by tradespersons skilled in their respective lines of Work. When completed, parts shall have been durably and substantially built and present a neat appearance.

4.02 COORDINATION

- A. Contractor shall coordinate installation of Work so as to not interfere with installation of others. Adjustment or rework because of Contractor's failure to coordinate will be at no additional cost to District.
- B. Contractor shall examine in-place work for readiness, completeness, fitness to be concealed or to receive other work, and in compliance with Contract Documents. Concealing or covering Work constitutes acceptance of additional cost which will result should in-place Work be found unsuitable for receiving other Work or otherwise deviating from the requirements of the Contract Documents.

4.03 COMPLETENESS

Contractor shall provide all portions of the Work, unless clearly stated otherwise, installed complete and operational with all elements, accessories, anchorages, utility connections, etc., in manner to assure well-balanced performance, in accordance with manufacturer's recommendations and by Contract Documents. For example, electric water coolers require water, electricity, and drain services; roof drains require drain system; sinks fit within countertop, etc. Terms such as "installed complete," "operable condition," "for use intended," "connected to all utilities," "terminate with proper cap," "adequately anchored," "patch and refinish," "to match similar," should be assumed to apply in all cases, except where completeness of functional or operable condition is specifically stated as not required.

4.04 APPROVED INSTALLER OR APPLICATOR

Installation by a manufacturer's approved installer or applicator is an understood part of Specifications and only approved installer or applicator is to provide on-site Work where specified manufacturer has on-going program of approving (i.e. certifying, bonding, re-warranting) installers or applicators. Newly established relationships between a manufacturer and an installer or applicator who does not have other approved applicator work in progress or completed is not approved for this Project.

4.05 MANUFACTURER'S RECOMMENDATIONS

All installations shall be in accordance with manufacturer's published recommendations and specific written directions of manufacturer's representative. Should Contract Documents differ from recommendations of manufacturer or directions of his representative, Contractor shall analyze differences, make recommendations to the District and the Architect in writing, and shall not proceed until interpretation or clarification has been issued by the District and/or the Architect.

END OF DOCUMENT

QUALITY CONTROL

PART 1 - GENERAL

1.01 RELATED DOCUMENTS AND PROVISIONS:

All Contract Documents should be reviewed for applicable provisions related to the provisions in this document, including without limitation:

- A. General Conditions, including, without limitation, Inspector, Inspections and Tests, Uncovering of Work and Non-conforming of Work and Correction of Work;
- B. Special Conditions.

1.02 RELATED CODES:

- A. The Work is governed by requirements of Title 24, California Code of Regulations ("CCR"), and the Contractor shall keep a copy of these available at the job Site for ready reference during construction.
- B. The Division of the State Architect ("DSA") shall be notified at or before the start of construction.

1.03 OBSERVATION AND SUPERVISION:

- A. The District and Architect or their appointed representatives will review the Work and the Contractor shall provide facilities and access to the Work at all times as required to facilitate this review. Administration by the Architect and any consulting Structural Engineer will be in accordance with applicable regulations, including, without limitation, CCR, Part 1, Title 24, Section 4-341.
- B. One or more Project Inspector(s) approved by DSA and employed by or in contract with the District, referred to hereinafter as the "Project Inspector", will observe the work in accordance with CCR, Part 1, Title 24, Sections 4-333(b) and 4-342:
 - (1) The Project Inspector and Special Inspector(s) shall have access to the Work wherever it is in preparation or progress for ascertaining that the Work is in accordance with the Contract Documents and all applicable code sections. The Contractor shall provide facilities and operation of equipment as needed, and access as required and shall provide assistance for sampling or measuring materials.
 - (2) The Project Inspector will notify the District and Architect and call the attention of the Contractor to any observed failure of Work or material to conform to Contract Documents.

- (3) The Project Inspector shall observe and monitor all testing and inspection activities required.

The Contractor shall conform with all applicable laws as indicated in the Contract Documents, including, without limitation, to CCR, Part 1, Title 24, Section 4-343. The Contractor shall supervise and direct the Work and maintain a competent superintendent on the job who is authorized to act in all matters pertaining to the Work. The Contractor's superintendent shall also inspect all materials, as they arrive, for compliance with the Contract Documents. Contractor shall reject defective Work or materials immediately upon delivery or failure of the Work or material to comply with the Contract Documents. The Contractor shall submit verified reports as indicated in the Contract Documents, including, without limitation, the Specifications and as required by Part 1, Title 24, Section 4-336.

1.04 TESTING AGENCIES:

- A. Testing agencies and tests shall be in conformance with the General Documents and the requirements of Part 1, Title 24, Section 4- 335.
- B. Testing and inspection in connection with earthwork shall be under the direction of the District's consulting soils engineer, if any, referred to hereinafter as the "Soils Engineer."
- C. Testing and inspection of construction materials and workmanship shall be performed by a qualified laboratory, referred to hereinafter as the "Testing Laboratory." The Testing Laboratory shall be under direction of an engineer registered in the State of California, shall conform to requirements of ASTM E329, and shall be employed by or in contract with the District.

1.05 TESTS AND INSPECTIONS:

- A. The Contractor shall be responsible for notifying the District and Project Inspector of all required tests and inspections. Contractor shall notify the District and Project Inspector at least seventy-two hours (72) hours in advance of performing any Work requiring testing or inspection.
- B. The Contractor shall provide access to Work to be tested and furnish incidental labor, equipment, and facilities to facilitate all inspections and tests.
- C. The District will pay for first inspections and tests required by the "CCR", and other inspections or tests that the District and/or the Architect may direct to have made, including the following principal items:
 - (1) Tests and observations for earthwork and paving.
 - (2) Tests for concrete mix designs, including tests of trial batches.
 - (3) Tests and inspections for structural steel work.
 - (4) Field tests for framing lumber moisture content.

- (5) Additional tests directed by the District that establish that materials and installation comply with the Contract Documents.
 - (6) Tests and observations of welding and expansion anchors.
- D. The District may at its discretion, pay and then back charge the Contractor for:
- (1) Retests or reinspection's, if required, and tests or inspections required due to Contractor error or lack of required identifications of material.
 - (2) Uncovering of work in accordance with Contract Documents.
 - (3) Testing done on weekends, holidays, and overtime will be chargeable to the Contractor for the overtime portion.
 - (4) Testing done off Site.
- E. Testing and inspection reports and certifications:
- (1) If initially received by Contractor, Contractor shall provide to each of the following a copy of the agency or laboratory report of each test or inspection or certification.
 - (a) The District;
 - (b) The Construction Manager, if any;
 - (c) The Architect;
 - (d) The Consulting Engineer, if any;
 - (e) Other engineers on the Project, as appropriate;
 - (f) The Project Inspector; and
 - (g) The Contractor.
 - (2) When the test or inspection is one required by the CCR, a copy of the report shall also be provided to the DSA.

PART 2 - PRODUCTS

2.01 TYPE OF TESTS AND INSPECTIONS – Not Used

PART 3 - EXECUTION Not Used.

END OF DOCUMENT

TEMPORARY FACILITIES AND CONTROLS

PART 1 – GENERAL

1.01 RELATED DOCUMENTS AND PROVISIONS:

All Contract Documents should be reviewed for applicable provisions related to the provisions in this document, including without limitation:

- A. General Conditions;
- B. Special Conditions;
- C. Site Standards; and
- D. Construction Waste Management and Disposal.

1.02 TEMPORARY UTILITIES:

- A. Electric Power and Lighting:
 - (1) Contractor will pay for power during the course of the Work. To the extent power is available in the building(s) or on the Site, Contractor may use the District's existing utilities by making prearranged payments to the District for the utilities used by Contractor and all Subcontractors. Contractor shall be responsible for providing temporary facilities required to deliver that power service from its existing location in the building(s) or on the Site to point of intended use.
 - (2) Contractor shall verify characteristics of power available in building(s) or on the Site. Contractor shall take all actions required to make modifications where power of higher voltage or different phases of current are required. Contractor shall be fully responsible for providing that service and shall pay all costs required therefor.
 - (3) Contractor shall furnish, wire for, install, and maintain temporary electrical lights wherever it is necessary to provide illumination for the proper performance and/or observation of the Work: a minimum of 20 foot-candles for rough work and 50 foot-candles for finish work.
 - (4) Contractor shall be responsible for maintaining existing lighting levels in the project vicinity should temporary outages or service interruptions occur.
- B. Heat and Ventilation:
 - (1) Contractor shall provide temporary heat to maintain environmental conditions to facilitate progress of the Work, to meet specified

minimum conditions for the installation and curing of materials, and to protect materials and finishes from damage due to improper temperature and humidity conditions. Portable heaters shall be standard units complete with controls.

- (2) Contractor shall provide forced ventilation and dehumidification, as required, of enclosed areas for proper installation and curing of materials, to disperse humidity, and to prevent hazardous accumulations of dust, fumes, vapors, and gases.
- (3) Contractor shall pay the costs of installation, maintenance, operation, and removal of temporary heat and ventilation, including costs for fuel consumed, required for the performance of the Work.

C. Water:

- (1) Contractor shall pay for water used during the course of the Work. Contractor shall coordinate and pay for installation or use of water meter in compliance with local water agency requirements. To the extent water is then available in the building(s) or on the Site, Contractor may use the District's existing utilities by making prearranged payments to the District for the utilities used by Contractor and all Subcontractors. Contractor shall be responsible for providing temporary facilities required to deliver such utility service from its existing location in the building(s), on the Site, or other location approved by the local water agency, to point of intended use.
- (2) Contractor shall use backflow preventers on water lines at point of connection to District's water supply. Backflow preventers shall comply with requirements of Uniform Plumbing Code.
- (3) Contractor shall make potable water available for human consumption.

D. Sanitary Facilities:

- (1) Contractor shall provide sanitary temporary facilities in no fewer numbers than required by law and such additional facilities as may be directed by the Inspector for the use of all workers. The facilities shall be maintained in a sanitary condition at all times and shall be left at the Site until removal is directed by the Inspector or Contractor completes all other work at the Site.
- (2) Use of toilet facilities in the Work under construction shall not be permitted except by consent of the Inspector and the District.

E. Telephone Service:

- (1) Contractor shall arrange with local telephone service company for telephone service as required for the performance of the Work. Contractor shall, at a minimum, provide in its field office one line for telephone and one line for fax machine.

- (2) Contractor shall pay the costs for telephone and fax lines installation, maintenance, service, and removal.

F. Fire Protection:

- (1) Contractor shall provide and maintain fire extinguishers and other equipment for fire protection. Such equipment shall be designated for use for fire protection only and shall comply with all requirements of the California Fire, State Fire Marshall and/or its designee.
- (2) Where on-site welding and burning of steel is unavoidable, Contractor shall provide protection for adjacent surfaces.

G. Trash Removal:

- (1) Contractor shall provide trash removal on a daily basis. Under no circumstance shall Contractor use District trash service.

H. Field Office:

- (1) If Contractor chooses to provide a field office, it shall be an acceptable construction trailer that is well-lit and ventilated. The construction trailer shall be equipped with shelves, desks, filing cabinet, chairs, and such other items of equipment needed. Trailer and equipment are the property of the Contractor and must be removed from the Site upon completion of the Work.
- (2) Contractor shall provide any additional electric lighting and power required for the trailer. Contractor shall make adequate provisions for heating and cooling as required.

I. Temporary Facilities:

- (1) N/A

1.03 CONSTRUCTION AIDS:

A. Plant and Equipment:

- (1) Contractor shall furnish, operate, and maintain a complete plant for fabricating, handling, conveying, installing, and erecting materials and equipment; and for conveyances for transporting workers. Include elevators, hoists, debris chutes, and other equipment, tools, and appliances necessary for performance of the Work.
- (2) Contractor shall maintain plant and equipment in safe and efficient operating condition. Damages due to defective plant and equipment, and uses made thereof, shall be repaired by Contractor at no expense to the District.

B. None of the District's tools and equipment shall be used by Contractor for the performance of the Work.

1.04 BARRIERS AND ENCLOSURES:

- A. Contractor shall obtain the District's written permission for locations and types of temporary barriers and enclosures, including fire-rated materials proposed for use, prior to their installation.
- B. Contractor shall provide and maintain temporary enclosures to prevent public entry and to protect persons using other buildings and portions of the Site and/or Premises, the public, and workers. Contractor shall also protect the Work and existing facilities from the elements, and adjacent construction and improvements, persons, and trees and plants from damage and injury from demolition and construction operations.
- C. Contractor shall provide site access to existing facilities for persons using other buildings and portions of the Site, the public, and for deliveries and other services and activities.
- D. Tree and Plant Protection:
 - (1) Contractor shall preserve and protect existing trees and plants on the Premises that are not designated or required to be removed, and those adjacent to the Premises.
 - (2) Contractor shall provide barriers to a minimum height of 4'-0" around drip line of each tree and plant, around each group of trees and plants, as applicable, in the proximity of demolition and construction operations, or as denoted on the Plans.
 - (3) Contractor shall not park trucks, store materials, perform Work or cross over landscaped areas. Contractor shall not dispose of paint thinners, water from cleaning, plastering or concrete operations, or other deleterious materials in landscaped areas, storm drain systems, or sewers. Plant materials damaged as a result of the performance of the Work shall, at the option of the District and at Contractor's expense, either be replaced with new plant materials equal in size to those damaged or by payment of an amount representing the value of the damaged materials as determined by the District.
 - (4) Contractor shall remove soil that has been contaminated during the performance of the Work by oil, solvents, and other materials which could be harmful to trees and plants, and replace with good soil, at Contractor's expense.
 - (5) Excavation around Trees:
 - (a) Excavation within drip lines of trees shall be done only where absolutely necessary and with written permission from the District.
 - (b) Where trenching for utilities is required within drip lines, tunneling under and around roots shall be by hand digging and shall be approved by the District. Main lateral roots and

taproots shall not be cut. All roots 2 inches in diameter and larger shall be tunneled under and heavily wrapped with wet burlap so as to prevent scarring or excessive drying. Smaller roots that interfere with installation of new work may be cut with prior approval by the District. Roots must first be cut with a Vermeer, or equivalent, root cutter prior to any trenching.

- (c) Where excavation for new construction is required within drip line of trees, hand excavation shall be employed to minimize damage to root system. Roots shall be relocated in backfill areas wherever possible. If encountered immediately adjacent to location of new construction, roots shall be cut approximately 6 inches back from new construction.
- (d) Approved excavations shall be carefully backfilled with the excavated materials approved for backfilling. Backfill shall conform to adjacent grades without dips, sunken areas, humps, or other surface irregularities. Do not use mechanical equipment to compact backfill. Tamp carefully using hand tools, refilling and tamping until Final Acceptance as necessary to offset settlement.
- (e) Exposed roots shall not be allowed to dry out before permanent backfill is placed. Temporary earth cover shall be provided, or roots shall be wrapped with four layers of wet, untreated burlap and temporarily supported and protected from damage until permanently relocated and covered with backfill.
- (f) Accidentally broken roots should be sawed cleanly 3 inches behind ragged end.

1.05 SECURITY:

The Contractor shall be responsible for project security for materials, tools, equipment, supplies, and completed and partially completed Work.

1.06 TEMPORARY CONTROLS:

A. Noise Control:

- (1) Contractor acknowledges that adjacent facilities may remain in operation during all or a portion of the Work period, and it shall take all reasonable precautions to minimize noise as required by applicable laws and the Contract Documents.
- (2) Notice of proposed noisy operations, including without limitation, operation of pneumatic demolition tools, concrete saws, and other equipment, shall be submitted to the District a minimum of forty-eight (48) hours in advance of their performance.

B. Noise and Vibration:

- (1) Equipment and impact tools shall have intake and exhaust mufflers.
- (2) Contractor shall cooperate with District to minimize and/or cease the use of noisy and vibratory equipment if that equipment becomes objectionable by its longevity.

C. Dust and Dirt:

- (1) Contractor shall conduct demolition and construction operations to minimize the generation of dust and dirt, and prevent dust and dirt from interfering with the progress of the Work and from accumulating in the Work and adjacent areas including, without limitation, occupied facilities.
- (2) Contractor shall periodically water exterior demolition and construction areas to minimize the generation of dust and dirt.
- (3) Contractor shall ensure that all hauling equipment and trucks carrying loads of soil and debris shall have their loads sprayed with water or covered with tarpaulins, and as otherwise required by local and state ordinance.
- (4) Contractor shall prevent dust and dirt from accumulating on walks, roadways, parking areas, and planting, and from washing into sewer and storm drain lines.

D. Water:

- (1) Contractor shall not permit surface and subsurface water, and other liquids, to accumulate in or about the vicinity of the Premises. Should accumulation develop, Contractor shall control the water or other liquid, and suitably dispose of it by means of temporary pumps, piping, drainage lines, troughs, ditches, dams, or other methods.

E. Pollution:

- (1) No burning of refuse, debris, or other materials shall be permitted on or in the vicinity of the Premises.
- (2) Contractor shall comply with applicable regulatory requirements and anti-pollution ordinances during the conduct of the Work including, without limitation, demolition, construction, and disposal operations.

F. Lighting:

- (1) If portable lights are used after dark, all light must be located so as not to direct light into neighboring property.

1.07 JOB SIGN(S):

A. General:

- (1) Contractor shall provide and maintain a Project identification sign with the design, text, and colors designated by the District and/or the Design Professional; locate sign as approved by the District.
- (2) Signs other than the specified Project sign and or signs required by law, for safety, or for egress, shall not be permitted, unless otherwise approved in advance by the District.

B. Materials:

- (1) Structure and Framing: Structurally sound, new or used wood or metal; wood shall be nominal 3/4-inch exterior grade plywood.
- (2) Sign Surface: Minimum 3/4-inch exterior grade plywood.
- (3) Rough Hardware: Galvanized.
- (4) Paint: Exterior quality, of type and colors selected by the District and/or the Design Professional.

C. Fabrication:

- (1) Contractor shall fabricate to provide smooth, even surface for painting.
- (2) Size: 4'-0" x 8'-0", unless otherwise indicated.
- (3) Contractor shall paint exposed surfaces of supports, framing, and surface material with exterior grade paint: one coat of primer and one coat of finish paint.
- (4) Text and Graphics: As indicated.

1.08 PUBLICITY RELEASES:

- A. Contractor shall not release any information, story, photograph, plan, or drawing relating information about the Project to anyone, including press and other public communications medium, including, without limitation, on website(s) without the written permission of the District.

PART 2 – PRODUCTS Not used.

PART 3 – EXECUTION Not used.

END OF DOCUMENT

CONSTRUCTION WASTE MANAGEMENT AND DISPOSAL

PART 1 - GENERAL

1.01 RELATED DOCUMENTS AND PROVISIONS:

All Contract Documents should be reviewed for applicable provisions related to the provisions in this document, including without limitation:

- A. General Conditions;
- B. Special Conditions; and
- C. Temporary Facilities and Controls.

1.02 SECTION INCLUDES:

- A. Administrative and procedural requirements for the following:
 - (1) Salvaging non-hazardous construction waste.
 - (2) Recycling non-hazardous construction waste.
 - (3) Disposing of non-hazardous construction waste.

1.03 DEFINITIONS:

- A. Construction Waste: Building and site improvement materials and other solid waste resulting from construction, remodeling, renovation, or repair operations. Construction waste includes packaging.
- B. Demolition Waste: Building and site improvement materials resulting from demolition or selective demolition operations.
- C. Disposal: Removal off-site of demolition and construction waste and subsequent sale, recycling, reuse, or deposit in landfill or incinerator acceptable to authorities having jurisdiction.
- D. Recycle: Recovery of demolition or construction waste for subsequent processing in preparation for reuse.
- E. Salvage: Recovery of demolition or construction waste and subsequent sale or reuse in another facility.
- F. Salvage and Reuse: Recovery of demolition or construction waste and subsequent incorporation into the Work.

1.04 PERFORMANCE REQUIREMENTS:

- A. General: Develop waste management plan that results in end-of Project rates for salvage/recycling of sixty-five percent (65%) by weight (or by volume, but not a combination) of total waste generated by the Work.

1.05 SUBMITTALS:

- A. Waste Management Plan: Submit waste management plan within 30 days of date established for commencement of the Work.
- B. Waste Reduction Progress Reports: Concurrent with each Application for Payment, submit copies of report. Include the following information:
 - (1) Material category.
 - (2) Generation point of waste.
 - (3) Total quantity of waste in tons or cubic yards.
 - (4) Quantity of waste salvaged, both estimated and actual in tons or cubic yards.
 - (5) Quantity of waste recycled, both estimated and actual in tons or cubic yards.
 - (6) Total quantity of waste recovered (salvaged plus recycled) in tons or cubic yards.
 - (7) Total quantity of waste recovered (salvaged plus recycled) as a percentage of total waste.
- C. Waste Reduction Calculations: Before request for final payment, submit copies of calculated end-of-Project rates for salvage, recycling, and disposal as a percentage of total waste generated by the Work.
- D. Records of Donations: Indicate receipt and acceptance of salvageable waste donated to individuals and organizations. Indicate whether organization is tax exempt.
- E. Records of Sales: Indicate receipt and acceptance of salvageable waste sold to individuals and organizations. Indicate whether organization is tax exempt.
- F. Recycling and Processing Facility Records: Indicate receipt and acceptance of recyclable waste by recycling and processing facilities licensed to accept them. Include manifests, weight tickets, receipts, and invoices.
- G. Landfill and Incinerator Disposal Records: Indicate receipt and acceptance of waste by landfills and incinerator facilities licensed to accept them. Include manifests, weight tickets, receipts, and invoices.

- H. CHPS Submittal: CHPS letter template for Credit ME2.0 and ME2.1, signed by Contractor, tabulating total waste material, quantities diverted and means by which it is diverted, and statement that requirements for the credit have been met.
- I. Qualification Data: For Waste Management Coordinator.
- J. Statement of Refrigerant Recovery: Signed by refrigerant recovery technician responsible for recovering refrigerant, stating that all refrigerant that was present was recovered and that recovery was performed according to EPA regulations. Include name and address of technician and date refrigerant was recovered.
- K. Submittal procedures and quantities are specified in Document 01 33 00.

1.06 QUALITY ASSURANCE:

- A. Waste Management Coordinator Qualifications: LEED Accredited Professional by U.S. Green Building Council.
- B. Regulatory Requirements: Comply with hauling and disposal regulations of authorities having jurisdiction.
- C. Waste Management Conference: Conduct conference at Project site to comply with requirements. Review methods and procedures related to waste management including, but not limited to, the following:
 - (1) Review and discuss waste management plan including responsibilities of Waste Management Coordinator.
 - (2) Review requirements for documenting quantities of each type of waste and its disposition.
 - (3) Review and finalize procedures for materials separation and verify availability of containers and bins needed to avoid delays.
 - (4) Review procedures for periodic waste collection and transportation to recycling and disposal facilities.
 - (5) Review waste management requirements for each trade.

1.07 WASTE MANAGEMENT PLAN:

- A. General: Develop plan consisting of waste identification, waste reduction work plan, and cost/revenue analysis. Indicate quantities by weight or volume, but use same units of measurement throughout waste management plan.
- B. Waste Identification: Indicate anticipated types and quantities of site-clearing and construction waste generated by the Work. Include estimated quantities and assumptions for estimates.

- C. Waste Reduction Work Plan: List each type of waste and whether it will be salvaged, recycled, or disposed of in landfill or incinerator. Include points of waste generation, total quantity of each type of waste, quantity for each means of recovery, and handling and transportation procedures.
- (1) Salvaged Materials for Reuse: For materials that will be salvaged and reused in this Project, describe methods for preparing salvaged materials before incorporation into the Work.
 - (2) Salvaged Materials for Sale: For materials that will be sold to individuals and organizations, include list of their names, addresses, and telephone numbers.
 - (3) Salvaged Materials for Donation: For materials that will be donated to individuals and organizations, include list of their names, addresses, and telephone numbers.
 - (4) Recycled Materials: Include list of local receivers and processors and type of recycled materials each will accept. Include names, addresses, and telephone numbers.
 - (5) Disposed Materials: Indicate how and where materials will be disposed of. Include name, address, and telephone number of each landfill and incinerator facility.
 - (6) Handling and Transportation Procedures: Include method that will be used for separating recyclable waste including sizes of containers, container labeling, and designated location on Project site where materials separation will be located.

PART 2 - PRODUCTS Not Used.

PART 3 - EXECUTION

3.01 PLAN IMPLEMENTATION:

- A. General: Implement approved waste management plan. Provide handling, containers, storage, signage, transportation, and other items as required to implement waste management plan during the entire duration of the Contract.
- (1) Comply with Document 01 50 00 for operation, termination, and removal requirements.
- B. [Waste Management Coordinator: Engage a waste management coordinator to be responsible for implementing, monitoring, and reporting status of waste management work plan. Coordinator shall be present at Project site full time for duration of Project.]
- C. Training: Train workers, subcontractors, and suppliers on proper waste management procedures, as appropriate for the Work occurring at Project site.

- (1) Distribute waste management plan to everyone concerned within 3 days of submittal return.
 - (2) Distribute waste management plan to entities when they first begin work on site. Review plan procedures and locations established for salvage, recycling, and disposal.
- D. Site Access and Temporary Controls: Conduct waste management operations to ensure minimum interference with roads, streets, walks, walkways, and other adjacent occupied and used facilities.
- (1) Designate and label specific areas of Project site necessary for separating materials that are to be salvaged, recycled, reused, donated, and sold.
 - (2) Comply with Document 01 50 00 for controlling dust and dirt, environmental protection, and noise control.

3.02 RECYCLING CONSTRUCTION WASTE:

- A. General: Recycle paper and beverage containers used by on-site workers.
- B. Recycling Incentives: Revenues, savings, rebates, tax credits, and other incentives received for recycling waste materials shall accrue to the Contractor.
- C. Procedures: Separate recyclable waste from other waste materials, trash, and debris. Separate recyclable waste by type at Project site to the maximum extent practical.
- (1) Provide appropriately marked containers or bins for controlling recyclable waste until they are removed from Project Site. Include list of acceptable and unacceptable materials at each container and bin.
 - (a) Inspect containers and bins for contamination and remove contaminated materials if found.
 - (2) Stockpile processed materials on site without intermixing with other materials. Place, grade, and shape stockpiles to drain surface water. Cover to prevent windblown dust.
 - (3) Stockpile materials away from construction area. Do not store within drip line of remaining trees.
 - (4) Store components off the ground and protect from the weather.
 - (5) Remove recyclable waste off District property and transport to recycling receiver or processor.

- D. Packaging:
 - (1) Cardboard and Boxes: Break down packaging into flat sheets. Bundle and store in a dry location.
 - (2) Polystyrene Packaging: Separate and bag material.
 - (3) Pallets: As much as possible, require deliveries using pallets to remove pallets from Project Site. For pallets that remain on Site, break down pallets into component wood pieces and comply with requirements for recycling wood.
 - (4) Crates: Break down crates into component wood pieces and comply with requirements for recycling wood.
- E. Site-Clearing Wastes: Chip brush, branches, and trees on site.
- F. Wood Materials:
 - (1) Clean Cut-Offs of Lumber: Grind or chip into small pieces.
 - (2) Clean Sawdust: Bag sawdust that does not contain painted or treated wood.
- G. Gypsum Board: Stack large clean pieces on wood pallets and store in a dry location.
 - (1) Clean Gypsum Board: Grind scraps of clean gypsum board using small mobile chipper or hammer mill. Screen out paper after grinding.

3.03 DISPOSAL OF WASTE:

- A. General: Except for items or materials to be salvaged, recycled, or otherwise reused, remove waste materials from Project Site and legally dispose of them in a landfill or incinerator acceptable to authorities having jurisdiction.
 - (1) Except as otherwise specified, do not allow waste materials that are to be disposed of accumulate on site.
 - (2) Remove and transport debris in a manner that will prevent spillage on adjacent surfaces and areas.
- B. Burning: Do not burn waste materials.
- C. Disposal: Transport waste materials off District property and legally dispose of them.

END OF DOCUMENT

OWNER-FURNISHED PRODUCTS

PART 4 – GENERAL

4.01 RELATED DOCUMENTS AND PROVISIONS

All Contract Documents should be reviewed for applicable provisions related to the provisions in this document, including without limitation:

- A. General Conditions;
- B. Special Conditions; and
- C. Materials and Equipment.

4.02 SECTION INCLUDES

- A. Requirements for the following:
 - (1) Installing Owner-furnished materials and equipment.
 - (2) Providing necessary utilities, connections and rough-ins.

4.03 DEFINITIONS

- A. Owner: District, who is providing/furnishing materials and equipment.
- B. Installing Contactor: Contractor, who is installing the materials and equipment furnished by the Owner.

4.04 PRODUCT DELIVERY, STORAGE, AND HANDLING

- A. Receive, store and handle products in accordance with the manufacturer's instructions.
- B. Protect equipment items as required to prevent damage during storage and construction.

PART 5 – PRODUCTS

5.01 GENERAL PRODUCT REQUIREMENTS

- A. Installing Contractor's Responsibilities:
 - (1) Verify mounting and utility requirements for Owner-furnished materials and equipment items.
 - (2) Provide mounting and utility rough in for all items where required.

- (a) Rough in locations, sizes, capacities, and similar type items shall be as indicated and required by product manufacturer.

B. Owner and Installing Contractor(s) Responsibilities:

- (1) Owner-Furnished/Contractor Installed ("OFICI"): Furnished by the Owner; installed by the Installing Contractor.
 - (a) General: Owner and Installing Contractor(s) will coordinate deliveries of materials and equipment to coincide with the construction schedule.
 - (b) Owner will furnish specified materials and equipment delivered to the site. Owner/vendor's representative shall be present on Site at the time of delivery to comply with the contract requirements and Specifications Section 01 43 00, Materials and Equipment, Article 1.04.
 - (c) The Owner furnishing specified materials and equipment is responsible to provide manufacturer guarantees as required by the Contract to the Installing Contractor.
 - (d) The Installing Contractor shall:
 - 1) Review, verify and accept the approved manufacturer's submittal/Shop Drawings for all materials and equipment required to be installed by the Installer Contractor and furnished by the Owner. Any discrepancies, including but not limited to possible space conflicts, should be brought to the attention of the Project Manager and/or Program Manager, if applicable.
 - 2) Coordinate timely delivery. Installing Contractor shall receive materials and equipment at Site when delivered and give written receipt at time of delivery, noting visible defects or omissions; if such declaration is not given, the Installing Contractor shall assume responsibility for such defects and omissions.
 - 3) Store materials and equipment until ready for installation and protect from loss and damage. Installing Contractor is responsible for providing adequate storage space.
 - 4) Coordinate with other bid package contractors and field measurement to ensure complete installation.
 - 5) Uncrate, assemble, and set in place.
 - 6) Provide adequate supports.

- 7) Install materials and equipment in accordance with manufacturer's recommendations, instructions, and Shop Drawings, supply labor and material required, and make mechanical, plumbing, and electrical connections required to operate equipment.
- 8) Be certified by equipment manufacturer for installation of the specific equipment supplied by the Owner.
- 9) Provide anchorage and/or bracing as required for seismic restraint per Title 24, UBC Standard 27-11 and all other applicable codes.
- 10) Provide the contract-required warranty and guarantee for all work, materials and equipment, and installation upon its completion and acceptance by the District. Guarantee includes all costs associated with the removal, shipping to and from the Site, and re-installation of any equipment found to be defective.

C. Compatibility with Space and Service Requirements:

- (1) Equipment items shall be compatible with space limitations indicated and as shown on the Contract Documents and specified in other sections of the Specifications.
- (2) Modifications to equipment items required to conform to space limitations specified for rough in shall not cause additional cost to the District.

D. Manufacturer's printed descriptions, specifications, and instructions shall govern the Work unless specifically indicated or specified otherwise.

5.02 FURNISHED MATERIALS AND EQUIPMENT

- A. All furnished materials and equipment are indicated or scheduled on the Contract Documents.

PART 6 – EXECUTION

6.01 INSTALLATION

- A. Install equipment items in accordance with the manufacturer's instructions.
- B. Set equipment items securely in place, rigidly or flexibly mounted in accordance with manufacturers' directions.
- C. Make electrical and mechanical connections as indicated and required.
- D. Touch-up and restore damaged or defaced finishes to the Owner's satisfaction.

6.02 CLEANING AND PROTECTION

- A. Repair or replace items not acceptable to the Architect or Owner.
- B. Upon completion of installation, clean equipment items in accordance with manufacturer's recommendations, and protect from damage until final acceptance of the Work by the Owner.

END OF DOCUMENT

SECTION 01 66 00

PRODUCT DELIVERY, STORAGE AND HANDLING

PART 1 - GENERAL

1.01 RELATED DOCUMENTS AND PROVISIONS

All Contract Documents should be reviewed for applicable provisions related to the provisions in this document, including without limitation:

- A. General Conditions, including, without limitation, Site Access, Conditions and Requirements;
- B. Special Conditions.

1.02 PRODUCTS

- A. Products are as defined in the General Conditions.
- B. Contractor shall not use and/or reuse materials and/or equipment removed from existing Premises, except as specifically permitted by the Contract Documents.
- C. Contractor shall provide interchangeable components of the same manufacturer, for similar components.

1.03 TRANSPORTATION AND HANDLING

- A. Contractor shall transport and handle Products in accordance with manufacturer's instructions.
- B. Contractor shall promptly inspect shipments to confirm that Products comply with requirements, quantities are correct, and products are undamaged.
- C. Contractor shall provide equipment and personnel to handle Products by methods to prevent soiling, disfigurement, or damage.

1.04 STORAGE AND PROTECTION

- A. Contractor shall store and protect Products in accordance with manufacturer's instructions, with seals and labels intact and legible. Contractor shall store sensitive products in weather-tight, climate-controlled enclosures.
- B. For exterior storage of fabricated Products, Contractor shall place on sloped supports, above ground.
- C. Contractor shall provide off-site storage and protection when Site does not permit on-site storage or protection.

- D. Contractor shall cover products subject to deterioration with impervious sheet covering and provide ventilation to avoid condensation.
- E. Contractor shall store loose granular materials on solid flat surfaces in a well-drained area and prevent mixing with foreign matter.
- F. Contractor shall provide equipment and personnel to store Products by methods to prevent soiling, disfigurement, or damage.
- G. Contractor shall arrange storage of Products to permit access for inspection and periodically inspect to assure Products are undamaged and are maintained under specified conditions.

PART 2 – PRODUCTS Not Used.

PART 3 - EXECUTION Not Used.

END OF DOCUMENT

CUTTING AND PATCHING

PART 1 – GENERAL

1.01 RELATED DOCUMENTS AND PROVISIONS:

All Contract Documents should be reviewed for applicable provisions related to the provisions in this document, including without limitation:

- A. General Conditions, including, without limitation, Inspector, Inspections, and Tests, Integration of Work, Nonconforming Work, and Correction of Work, and Uncovering Work;
- B. Special Conditions;
- C. Hazardous Materials Procedures and Requirements;
- D. Hazardous Materials Certification;
- E. Lead-Based Paint Certification;
- F. Imported Materials Certification.

1.02 CUTTING AND PATCHING:

- A. Contractor shall be responsible for all cutting, fitting, and patching, including associated excavation and backfill, required to complete the Work or to:
 - (1) Make several parts fit together properly.
 - (2) Uncover portions of Work to provide for installation of ill-timed Work.
 - (3) Remove and replace defective Work.
 - (4) Remove and replace Work not conforming to requirements of Contract Documents.
 - (5) Remove Samples of installed Work as specified for testing.
 - (6) Provide routine penetrations of non-structural surfaces for installation of piping and electrical conduit.
 - (7) Attaching new materials to existing remodeling areas – including painting (or other finishes) to match existing conditions.
- B. In addition to Contract requirements, upon written instructions from the District, Contractor shall uncover Work to provide for observations of covered Work in accordance with the Contract Documents; remove samples of

installed materials for testing as directed by District; and remove Work to provide for alteration of existing Work.

- C. Contractor shall not cut or alter Work, or any part of it, in such a way that endangers or compromises the integrity of the Work, the Project, or work of others.

1.03 SUBMITTALS:

- A. Prior to any cutting or alterations that may affect the structural safety of Project, or work of others, and well in advance of executing such cutting or alterations, Contractor shall submit written notice to District pursuant to the applicable notice provisions of the Contract Documents, requesting consent to proceed with the cutting or alteration, including the following:
 - (1) The work of the District or other trades.
 - (2) Structural value or integrity of any element of Project.
 - (3) Integrity or effectiveness of weather-exposed or weather-resistant elements or systems.
 - (4) Efficiency, operational life, maintenance or safety of operational elements.
 - (5) Visual qualities of sight-exposed elements.
- B. Contractor's Request shall also include:
 - (1) Identification of Project.
 - (2) Description of affected Work.
 - (3) Necessity for cutting, alteration, or excavations.
 - (4) Effects of Work on District, other trades, or structural or weatherproof integrity of Project.
 - (5) Description of proposed Work:
 - (a) Scope of cutting, patching, alteration, or excavation.
 - (b) Trades that will execute Work.
 - (c) Products proposed to be used.
 - (d) Extent of refinishing to be done.
 - (6) Alternates to cutting and patching.
 - (7) Cost proposal, when applicable.

- (8) The scheduled date the Contractor intends to perform the Work and the duration of time to complete the Work.
- (9) Written permission of District or other District contractor(s) whose work will be affected.

1.04 QUALITY ASSURANCE:

- A. Contractor shall ensure that cutting, fitting, and patching shall achieve security, strength, weather protection, appearance for aesthetic match, efficiency, operational life, maintenance, safety of operational elements, and the continuity of existing fire ratings.
- B. Contractor shall ensure that cutting, fitting, and patching shall successfully duplicate undisturbed adjacent profiles, materials, textures, finishes, colors, and that materials shall match existing construction. Where there is dispute as to whether duplication is successful or has been achieved to a reasonable degree, the District's decision shall be final.

1.05 PAYMENT FOR COSTS:

- A. Cost caused by ill-timed or defective Work or Work not conforming to Contract Documents, including costs for additional services of the District, its consultants, including but not limited to the Construction Manager, the Architect, the Project Inspector(s), Engineers, and Agents, will be paid by Contractor and/or deducted from the Contract by the District.
- B. District shall only pay for cost of Work if it is part of the original Contract Price or if a change has been made to the contract in compliance with the provisions of the General Conditions. Cost of Work performed upon instructions from the District, other than defective or nonconforming Work, will be paid by District on approval of written Change Order. Contractor shall provide written cost proposals prior to proceeding with cutting and patching.

PART 2 - PRODUCTS

2.01 MATERIALS:

- A. Contractor shall provide for replacement and restoration of Work removed. Contractor shall comply with the Contract Documents and with the Industry Standard(s), for the type of Work, and the Specification requirements for each specific product involved. If not specified, Contractor shall first recommend a product of a manufacturer or appropriate trade association for approval by the District.
- B. Materials to be cut and patched include those damaged by the performance of the Work.

PART 3 – EXECUTION

3.01 INSPECTION:

- A. Contractor shall inspect existing conditions of the Site and the Work, including elements subject to movement or damage during cutting and patching, excavating and backfilling. After uncovering Work, Contractor shall inspect conditions affecting installation of new products.
- B. Contractor shall report unsatisfactory or questionable conditions in writing to District as indicated in the General Conditions and shall proceed with Work as indicated in the General Conditions by District.

3.02 PREPARATION:

- A. Contractor shall provide shoring, bracing and supports as required to maintain structural integrity for all portions of the Project, including all requirements of the Project.
- B. Contractor shall provide devices and methods to protect other portions of Project from damage.
- C. Contractor shall, provide all necessary protection from weather and extremes of temperature and humidity for the Project, including without limitation, any work that may be exposed by cutting and patching Work. Contractor shall keep excavations free from water.

3.03 ERECTION, INSTALLATION AND APPLICATION:

- A. With respect to performance, Contractor shall:
 - (1) Execute fitting and adjustment of products to provide finished installation to comply with and match specified tolerances and finishes.
 - (2) Execute cutting and demolition by methods that will prevent damage to other Work, and provide proper surfaces to receive installation of repairs and new Work.
 - (3) Execute cutting, demolition excavating, and backfilling by methods that will prevent damage to other Work and damage from settlement.
- B. Contractor shall employ original installer or fabricator to perform cutting and patching for:
 - (1) Weather-exposed surfaces and moisture-resistant elements such as roofing, sheet metal, sealants, waterproofing, and other trades.
 - (2) Sight-exposed finished surfaces.
- C. Contractor shall execute fitting and adjustment of products to provide a finished installation to comply with specified products, functions, tolerances,

and finishes as shown or specified in the Contract Documents including, without limitation, the Drawings and Specifications.

- D. Contractor shall fit Work airtight to pipes, sleeves, ducts, conduit, and other penetrations through surfaces. Contractor shall conform to all Code requirements for penetrations or the Drawings and Specifications, whichever calls for a higher quality or more thorough requirement. Contractor shall maintain integrity of both rated and non-rated fire walls, ceilings, floors, etc.
- E. Contractor shall restore Work which has been cut or removed. Contractor shall install new products to provide completed Work in accordance with requirements of the Contract Documents and as required to match surrounding areas and surfaces.
- F. Contractor shall refinish all continuous surfaces to nearest intersection as necessary to match the existing finish to any new finish.

END OF DOCUMENT

ALTERATION PROJECT PROCEDURES

PART 1 – GENERAL

1.01 RELATED DOCUMENTS AND PROVISIONS:

All Contract Documents should be reviewed for applicable provisions related to the provisions in this document, including without limitation:

- A. General Conditions, including, without limitation, Integration of Work, Purchase of Materials and Equipment, Uncovering of Work and Non-conforming Work and Correction of Work and Trenches;
- B. Special Conditions.

PART 2 - PRODUCTS

2.01 PRODUCTS FOR PATCHING AND EXTENDING WORK:

- A. New Materials: As specified in the Contract Documents including, without limitation, in the Specifications, Contractor shall match existing products, conditions, and work for patching and extending work.
- B. Type and Quality of Existing Products: Contractor shall determine by inspection, by testing products where necessary, by referring to existing conditions and to the Work as a standard.

PART 3 - EXECUTION

3.01 EXAMINATION:

- A. Contractor shall verify that demolition is complete and that areas are ready for installation of new Work.
- B. By beginning restoration Work, Contractor acknowledges and accepts the existing conditions.

3.02 PREPARATION:

- A. Contractor shall cut, move, or remove items as necessary for access to alterations and renovation Work. Contractor shall replace and restore these at completion.
- B. Contractor shall remove unsuitable material not as salvage unless otherwise indicated in the Contract Documents. Unsuitable material may include, without limitation, rotted wood, corroded metals, and deteriorated masonry and concrete. Contractor shall replace materials as specified for finished Work.

- C. Contractor shall remove debris and abandoned items from all areas of the Site and from concealed spaces.
- D. Contractor shall prepare surface and remove surface finishes to provide for proper installation of new Work and finishes.
- E. Contractor shall close openings in exterior surfaces to protect existing work from weather and extremes of temperature and humidity. Contractor shall insulate ductwork and piping to prevent condensation in exposed areas. Contractor shall insulate building cavities for thermal and/or acoustical protection, as detailed.

3.03 INSTALLATION:

- A. Contractor shall coordinate Work of all alternations and renovations to expedite completion and to accommodate District occupancy.
- B. Designated Areas and Finishes: Contractor shall complete all installations in all respects, including operational, mechanical work and electrical work.
- C. Contractor shall remove, cut, and patch Work in a manner to minimize damage and to provide a means of restoring Products and finishes to original or specified condition.
- D. Contractor shall refinish visible existing surfaces to remain in renovated rooms and spaces, to specified condition for each material, with a neat and square or straight transition to adjacent finishes.
- E. Contractor shall install products as specified in the Contract Documents, including without limitation, the Specifications.

3.04 TRANSITIONS:

- A. Where new Work abuts or aligns with existing, Contractor shall perform a smooth and even transition. Patched Work must match existing adjacent work in texture and appearance.
- B. When finished surfaces are cut so that a smooth transition with new Work is not possible, Contractor shall terminate existing surface along a straight line at a natural line of division and make a recommendation for resolution to the District and the Architect for review and approval.

3.05 ADJUSTMENTS:

- A. Where removal of partitions or walls results in adjacent spaces becoming one, Contractor shall rework floors, walls, and ceilings to a smooth plane without breaks, steps, or bulkheads.
- B. Where a change of plane of 1/4 inch or more occurs, Contractor shall submit a recommendation for providing a smooth transition to the District and the Architect for review and approval.

- C. Contractor shall trim and seal existing wood doors and shall trim and paint metal doors as necessary to clear new floor finish and refinish trim as required.
- D. Contractor shall fit Work at penetrations of surfaces.

3.06 REPAIR OF DAMAGED SURFACES:

- A. Contractor shall patch or replace portions of existing surfaces, which are damaged, lifted, discolored, or showing other imperfections, in the area where the Work is performed.
- B. Contractor shall repair substrate prior to patching finish.

3.07 CULTIVATED AREAS AND OTHER SURFACE IMPROVEMENTS:

- A. Cultivated or planted areas and other surface improvements which are damaged by actions of the Contractor shall be restored by Contractor to their original condition or better, where indicated.
- B. Contractor shall protect and replace, if damaged, all existing guard posts, barricades, and fences.
- C. Contractor shall give special attention to avoid damaging or killing trees, bushes and/or shrubs on the Premises and/or identified in the Contract Documents, including without limitation, the Drawings.

3.08 FINISHES:

- A. Contractor shall finish surfaces as specified in the Contract Documents, including without limitations, the provisions of all Divisions of the Specifications.
- B. Contractor shall finish patches to produce uniform finish and texture over entire area. When finish cannot be matched, Contractor shall refinish entire surface to nearest intersections.

3.09 CLEANING:

- A. Contractor shall continually clean the Site and the Premises as indicated in the Contract Documents, including without limitation, the provisions in the General Conditions and the Specifications regarding cleaning.

END OF DOCUMENT

CONTRACT CLOSEOUT AND FINAL CLEANING

PART 1 - GENERAL

1.01 RELATED DOCUMENTS AND PROVISIONS

All Contract Documents should be reviewed for applicable provisions related to the provisions in this document, including without limitation:

- A. General Conditions, including, without limitation, Completion of Work;
- B. Special Conditions;
- C. Temporary Facilities and Controls.

1.02 CLOSEOUT PROCEDURES

Contractor shall comply with all closeout provisions as indicated in the General Conditions.

1.03 FINAL CLEANING

- A. Contractor shall execute final cleaning prior to final inspection.
- B. Contractor shall clean interior and exterior glass and all surfaces exposed to view; remove temporary labels, tape, stains, and foreign substances, polish transparent and glossy surfaces, wax and polish new vinyl floor surfaces, vacuum carpeted and soft surfaces.
- C. Contractor shall clean equipment and fixtures to a sanitary condition.
- D. Contractor shall replace filters of operating equipment.
- E. Contractor shall clean debris from roofs, gutters, down spouts, and drainage systems.
- F. Contractor shall clean Site, sweep paved areas, and rake clean landscaped surfaces.
- G. Contractor shall remove waste and surplus materials, rubbish, and construction facilities from the Site and surrounding areas.

1.04 ADJUSTING

Contractor shall adjust operating products and equipment to ensure smooth and unhindered operation.

1.05 RECORD DOCUMENTS AND SHOP DRAWINGS

- A. Contractor shall legibly mark each item to record actual construction, including:
 - (1) Measured depths of foundation in relation to finish floor datum.
 - (2) Measured horizontal and vertical locations of underground utilities and appurtenances, referenced to permit surface improvements.
 - (3) Measured locations of internal utilities and appurtenances concealed in construction, referenced to visible and accessible features of the Work.
 - (4) Field changes of dimension and detail.
 - (5) Details not on original Contract Drawings
 - (6) Changes made by modification(s).
 - (7) References to related Shop Drawings and modifications.
- B. Contractor will provide one set of Record Drawings to District.
- C. Contractor shall submit all required documents to District and/or Architect prior to or with its final Application for Payment.

1.06 INSTRUCTION OF DISTRICT PERSONNEL

- A. Before final inspection, at agreed upon times, Contractor shall instruct District's designated personnel in operation, adjustment, and maintenance of products, equipment, and systems.
- B. For equipment requiring seasonal operation, Contractor shall perform instructions for other seasons within six months or by the change of season.
- C. Contractor shall use operation and maintenance manuals as basis for instruction. Contractor shall review contents of manual with personnel in detail to explain all aspects of operation and maintenance.
- D. Contractor shall prepare and insert additional data in Operation and Maintenance Manual when the need for such data becomes apparent during instruction.
- E. Contractor shall review contents of manual with personnel in detail to explain all aspects of operation and maintenance.

1.07 SPARE PARTS AND MAINTENANCE MATERIALS

- A. Contractor shall provide products, spare parts, maintenance, and extra materials in quantities specified in the Specifications and in Manufacturer's recommendations.

- B. Contractor shall provide District with all required Operation and Maintenance Data at one time. Partial or piecemeal submissions of Operation and Maintenance Data will not be accepted.

PART 2 – PRODUCTS Not Used.

PART 3 – EXECUTION Not Used.

END OF DOCUMENT

OPERATION AND MAINTENANCE DATA

PART 4 – GENERAL

4.01 RELATED DOCUMENTS AND PROVISIONS:

All Contract Documents should be reviewed for applicable provisions related to the provisions in this document, including without limitation:

- A. General Conditions, including, without limitation, Completion of the Work;
- B. Special Conditions.

4.02 QUALITY ASSURANCE:

Contractor shall prepare instructions and data by personnel experienced in maintenance and operation of described products.

4.03 FORMAT:

- A. Contractor shall prepare data in the form of an instructional manual entitled "OPERATIONS AND MAINTENANCE MANUAL & INSTRUCTIONS" ("Manual").
- B. Binders: Contractor shall use commercial quality, 8-1/2 by 11 inch, three-side rings, with durable plastic covers; two inch maximum ring size. When multiple binders are used, Contractor shall correlate data into related consistent groupings.
- C. Cover: Contractor shall identify each binder with typed or printed title "OPERATION AND MAINTENANCE MANUAL & INSTRUCTIONS"; and shall list title of Project and identify subject matter of contents.
- D. Contractor shall arrange content by systems process flow under section numbers and sequence of Table of Contents of the Contract Documents.
- E. Contractor shall provide tabbed fly leaf for each separate product and system, with typed description of product and major component parts of equipment.
- F. Text: The content shall include Manufacturer's printed data, or typewritten data on 24 pound paper.
- G. Drawings: Contractor shall provide with reinforced punched binder tab and shall bind in with text; folding larger drawings to size of text pages.

4.04 CONTENTS, EACH VOLUME:

- A. Table of Contents: Contractor shall provide title of Project; names, addresses, and telephone numbers of the Architect, any engineers, subconsultants,

Subcontractor(s), and Contractor with name of responsible parties; and schedule of products and systems, indexed to content of the volume.

- B. For Each Product or System: Contractor shall list names, addresses, and telephone numbers of Subcontractor(s) and suppliers, including local source of supplies and replacement parts.
- C. Product Data: Contractor shall mark each sheet to clearly identify specific products and component parts, and data applicable to installation. Delete inapplicable information.
- D. Drawings: Contractor shall supplement product data to illustrate relations of component parts of equipment and systems, to show control and flow diagrams. Contractor shall not use Project Record Documents as maintenance drawings.
- E. Text: Contractor shall include any and all information as required to supplement product data. Contractor shall provide logical sequence of instructions for each procedure, incorporating manufacturer's instructions.
- F. Warranties and Bonds: Contractor shall bind in one copy of each.

4.05 MANUAL FOR MATERIALS AND FINISHES:

- A. Building Products, Applied Materials, and Finishes: Contractor shall include product data, with catalog number, size, composition, and color and texture designations. Contractor shall provide information for re-ordering custom manufactured products.
- B. Instructions for Care and Maintenance: Contractor shall include Manufacturer's recommendations for cleaning agents and methods, precautions against detrimental agents and methods, and recommended schedule for cleaning and maintenance.
- C. Moisture Protection and Weather Exposed Products: Contractor shall include product data listing applicable reference standards, chemical composition, and details of installation. Contractor shall provide recommendations for inspections, maintenance, and repair.
- D. Additional Requirements: Contractor shall include all additional requirements as specified in the Specifications.
- E. Contractor shall provide a listing in Table of Contents for design data, with tabbed fly sheet and space for insertion of data.

4.06 MANUAL FOR EQUIPMENT AND SYSTEMS:

- A. Each Item of Equipment and Each System: Contractor shall include description of unit or system, and component parts and identify function, normal operating characteristics, and limiting conditions. Contractor shall include performance curves, with engineering data and tests, and complete nomenclature, and commercial number of replaceable parts.

- B. Panelboard Circuit Directories: Contractor shall provide electrical service characteristics, controls, and communications.
- C. Contractor shall include color coded wiring diagrams as installed.
- D. Operating Procedures: Contractor shall include start-up, break-in, and routine normal operating instructions and sequences. Contractor shall include regulation, control, stopping, shut-down, and emergency instructions. Contractor shall include summer, winter, and any special operating instructions.
- E. Maintenance Requirements: Contractor shall include routine procedures and guide for trouble-shooting; disassembly, repair, and reassembly instructions; and alignment, adjusting, balancing, and checking instructions.
- F. Contractor shall provide servicing and lubrication schedule, and list of lubricants required.
- G. Contractor shall include manufacturer's printed operation and maintenance instructions.
- H. Contractor shall include sequence of operation by controls manufacturer.
- I. Contractor shall provide original manufacturer's parts list, illustrations, assembly drawings, and diagrams required for maintenance.
- J. Contractor shall provide control diagrams by controls manufacturer as installed.
- K. Contractor shall provide Contractor's coordination drawings, with color coded piping diagrams as installed.
- L. Contractor shall provide charts of valve tag numbers, with location and function of each valve, keyed to flow and control diagrams.
- M. Contractor shall provide list of original manufacturer's spare parts, current prices, and recommended quantities to be maintained in storage.
- N. Additional Requirements: Contractor shall include all additional requirements as specified in Specification(s).
- O. Contractor shall provide a listing in Table of Contents for design data, with tabbed fly sheet and space for insertion of data.

4.07 SUBMITTAL:

- A. Contractor shall submit to the District for review two (2) copies of preliminary draft or proposed formats and outlines of the contents of the Manual within thirty (30) days of Contractor's start of Work.
- B. For equipment, or component parts of equipment put into service during construction and to be operated by District, Contractor shall submit draft

content for that portion of the Manual within ten (10) days after acceptance of that equipment or component.

- C. Contractor shall submit two (2) copies of a complete Manual in final form prior to final Application for Payment. Copy will be returned with Architect/Engineer comments. Contractor must revise the content of the Manual as required by District prior to District's approval of Contractor's final Application for Payment.
- D. Contractor must submit two (2) copies as well as a PDF in searchable and tabbed format in Specification Section order of revised Manual in final form within ten (10) days after final inspection.

PART 5 – PRODUCTS Not Used.

PART 6 – EXECUTION Not Used.

END OF DOCUMENT

WARRANTIES

PART 7 - GENERAL

7.01 RELATED DOCUMENTS AND PROVISIONS

All Contract Documents should be reviewed for applicable provisions related to the provisions in this document, including without limitation:

- A. General Conditions, including, without limitation, Warranty/Guarantee Information;
- B. Special Conditions.

7.02 FORMAT

- A. Binders: Contractor shall use commercial quality, 8-1/2 by 11 inch, three-side rings, with durable plastic covers; two inch maximum ring size. Warranties will be in Specification Section order and shall also be submitted in PDF Format
- B. Cover: Contractor shall identify each binder with typed or printed title "WARRANTIES" and shall list title of Project.
- C. Table of Contents: Contractor shall provide title of Project; name, address, and telephone number of Contractor and equipment supplier; and name of responsible principal. Contractor shall identify each item with the number and title of the specific Specification, document, provision, or section in which the name of the product or work item is specified.
- D. Contractor shall separate each warranty with index tab sheets keyed to the Table of Contents listing, providing full information and using separate typed sheets as necessary. Contractor shall list each applicable and/or responsible Subcontractor(s), supplier(s), and/or manufacturer(s), with name, address, and telephone number of each responsible principal(s).

7.03 PREPARATION:

- A. Contractor shall obtain warranties, executed in duplicate by each applicable and/or responsible subcontractor(s), supplier(s), and manufacturer(s), within ten (10) days after completion of the applicable item or work. Except for items put into use with District's permission, Contractor shall leave date of beginning of time of warranty blank until the date of completion is determined.
- B. Contractor shall verify that documents are in proper form, contain full information, and are notarized, when required.
- C. Contractor shall co-execute submittals when required.

D. Contractor shall retain warranties until time specified for submittal.

7.04 TIME OF SUBMITTALS:

- A. For equipment or component parts of equipment put into service during construction with District's permission, Contractor shall submit a draft warranty for that equipment or component within ten (10) days after acceptance of that equipment or component.
- B. Contractor shall submit for District approval all warranties and related documents within ten (10) days after date of completion. Contractor must revise the warranties as required by the District prior to District's approval of Contractor's final Application for Payment.
- C. For items of work delayed beyond date of completion, Contractor shall provide an updated submittal within ten (10) days after acceptance, listing the date of acceptance as start of warranty period.

PART 8 - PRODUCTS Not Used.

PART 9 – EXECUTION Not Used.

END OF DOCUMENT

RECORD DOCUMENTS

PART 10 - GENERAL

10.01 RELATED DOCUMENTS AND PROVISIONS:

All Contract Documents should be reviewed for applicable provisions related to the provisions in this document, including without limitation:

- A. General Conditions, including, without limitation, Documents on Work;
- B. Special Conditions.

PART 11 - RECORD DRAWINGS

11.01 GENERAL:

- A. As indicated in the Contract Documents, the District will provide Contractor with one set of reproducible, full size original Contract Drawings.
- B. Contractor shall maintain at each Project Site one set of marked-up plans and shall transfer all changes and information to those marked-up plans, as often as required in the Contract Documents, but in no case less than once each month. Contractor shall submit to the Project Inspector one set of reproducible Project Record Drawings ("As-Builts") in a format approved by the Inspector of Record and the District, showing all changes incorporated into the Work since the preceding monthly submittal. The As-Builts shall be available at the Project Site. The Contractor shall submit reproducible drawings at the conclusion of the Project following review of the blueline prints in a format approved by the District.
- C. Label and date each Record Drawing "RECORD DOCUMENT" in legibly printed letters.
- D. All deviations in construction, including but not limited to pipe and conduit locations and deviations caused by without limitation Change Orders, Construction Claim Directives, RFI's, and Addenda, shall be accurately and legibly recorded by Contractor.
- E. Locations and changes shall be done by Contractor in a neat and legible manner and, where applicable, indicated by drawing a "cloud" around the changed or additional information.

11.02 RECORD DRAWING INFORMATION:

- A. Contractor shall record the following information:

- (1) Locations of Work buried under or outside each building, including, without limitation, all utilities, plumbing and electrical lines, and conduits.
- (2) Actual numbering of each electrical circuit to match panel schedule.
- (3) Locations of significant Work concealed inside each building whose general locations are changed from those shown on the Contract Drawings.
- (4) Locations of all items, not necessarily concealed, which vary from the Contract Documents.
- (5) Installed location of all cathodic protection anodes.
- (6) Deviations from the sizes, locations, and other features of installations shown in the Contract Documents.
- (7) Locations of underground work, points of connection with existing utilities, changes in direction, valves, manholes, catch basins, capped stubouts, invert elevations, etc.
- (8) Sufficient information to locate Work concealed in each building with reasonable ease and accuracy.

In some instances, this information may be recorded by dimension. In other instances, it may be recorded in relation to the spaces in the building near which it was installed.

- B. Contractor shall provide additional drawings as necessary for clarification.
- C. Contractor shall provide reproducible record drawings, made from final Shop Drawings marked "No Exceptions Taken" or "Approved as Noted."
- D. After review and approval of the marked-up specifications by the Project Inspector, Contractor shall provide electronic copies of the drawings (in PDF format) with one file with all of the sheets and one set of individual sheet files at the conclusion of the Project.

PART 12 - RECORD SPECIFICATIONS

12.01 GENERAL:

- A. Contractor shall mark each section legibly to record manufacturer, trade name, catalog number, and supplier of each Product and item of equipment actually installed.
- B. After review and approval of the marked-up specifications by the Project Inspector, Contractor shall provide one electronic copy of the specifications (in PDF format) at the conclusion of the Project.

PART 13 - MAINTENANCE OF RECORD DOCUMENTS

13.01 GENERAL

- A. Contractor shall store Record Documents apart from documents used for construction as follows:
 - (1) Provide files and racks for storage of Record Documents.
 - (2) Maintain Record Documents in a clean, dry, legible condition and in good order.
- B. Contractor shall not use Record Documents for construction purposes.

PART 14 – PRODUCTS Not Used.

END OF DOCUMENT